

Solide Carbide/VHM

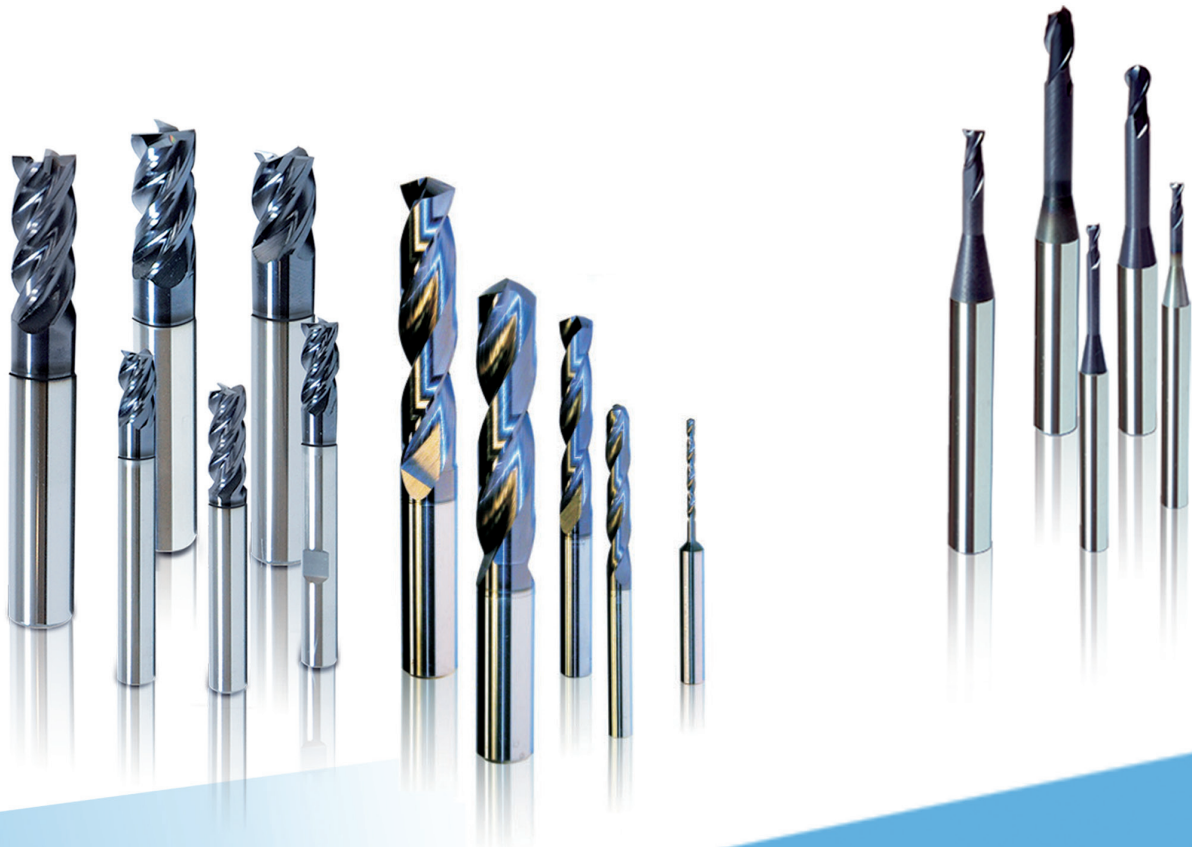

ZCC Cutting Tools Europe GmbH

your Partner | your Value



WELCOME TO ZCC CUTTING TOOLS EUROPE

ZCC-CT, one of the World's leading carbide tooling manufacturers, welcomes you to its products. We are able to offer you a wide product range of high performance cutting tools at economic prices and a good supply service to support the production and productivity at your manufacturing facilities. You will find the main tool types in the various sections of the catalogue, Turning is in section A, Milling in section B and Drilling in section C of the catalogue.

We are looking forward to working with you and developing good cooperation together. Our team at ZCC Cutting Tools Europe is ready to support you in all of your requirements.



Member of Minmetals Group



EUROPEAN HEADQUARTER / HAUPTSITZ IN EUROPA:

ZCC Cutting Tools GmbH, Heltorfer Str.12, 40472 Düsseldorf, Germany

Tel.: +49 (0) 211/989240-0, Fax: +49 (0) 211/ 989240-111

E-Mail: info@zccct-europe.com, www.zccct-europe.com, www.zccct.com



HERZLICH WILLKOMMEN BEI ZCC CUTTING TOOLS EUROPE

ZCC-CT, einer der weltweit führenden Hartmetall-Werkzeughersteller, begrüßt Sie recht herzlich. Mit unserer umfangreichen Produktpalette an Hochleistungs-Zerspanungswerkzeugen und entsprechenden Serviceleistungen möchten wir gerne bei Ihnen die Bearbeitungssicherheit und die Wirtschaftlichkeit erhöhen. In Teil A des Katalogs finden Sie die Werkzeuge zum Drehen, in Teil B zum Fräsen und in Teil C zum Bohren.

*Wir freuen uns auf eine gute Zusammenarbeit.
Ihr Team von ZCC Cutting Tools Europe steht Ihnen als Partner zur Seite!*

Copyright Katalog
©2016 ZCC Cutting Tools Europe GmbH

All rights reserved. All descriptions and pictures are protected by copyright. Usage, modification and reproduction, completely or partially, without written permission are prohibited. Subject to technical changes and changes of the delivery program. No responsibility for errors and printing errors are accepted.

Alle Rechte vorbehalten. Alle Beschreibungen und Abbildungen sind urheberrechtlich geschützt. Die Verwendung, Modifikation und Vervielfältigung, ganz oder teilweise, ohne schriftliche Genehmigung sind untersagt. Technische Änderungen und Änderungen des Lieferprogrammes vorbehalten. Für Druckfehler und Irrtümer kein Gewähr.





Content Inhaltsangabe

A Turning Drehen A1-A384	General Turning Allgemeine Drehbearbeitung	A1 -A283
	Parting and Grooving Ab- und Einstechen	A284-A325
	Thread Turning Gewindedrehen	A326-A384
B Milling Fräsen B1-B536	Milling Indexable Tools Fräsen - WSP Werkzeuge	B1 -B242
	Milling - Solid Carbide Endmills Fräsen VHM - Schaftfräser	B243-B536
C Drilling / Reaming / Threading Bohren / Reiben / Gewinde C1-C174	Drilling - Solid Carbide Drills Bohren - VHM Bohrer	C1 -C121
	Drilling Indexable Tools Bohren - WSP Werkzeuge	C122-C140
	Reaming Reiben	C141-C152
	Threading - Solid Carbide Tools Gewinde - VHM Gewindebohrer	C153-C167
	Solid Carbide Threading Endmills VHM Gewindefräser	C168-C174
D	General Technical Information Allgemeine Technische Informationen	D1 -D28
Index		I01 -I14

WSP = Wendeschneidplatte VHM = Vollhartmetall



New **UM Serie**

High performance cutter with uneven pitch and different helical angle.

Hochleistungsfräser mit ungleichem Spanwinkel und ungleicher Teilung.

















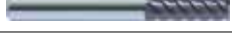

Milling · Fräsen

Solid Carbide End Mills · Vollhartmetallschaftfräser

- B 245-250** Solid carbide end mills overview
Vollhartmetall-Schaftfräser Überblick
- B 251** Grade introduction for solid carbide end mills
Hartmetallsorten für VHM-Fräser
- B 252, 254** Solid carbide end mills code key
Vollhartmetall-Schaftfräser ISO Kennzeichnung
- B 253, 255** Graphics identification and application
Graphische Werkzeug- und Anwendungsbeschreibung
- B 256-530** Solid carbide end mills program
Vollhartmetall-Schaftfräser Programm
- B 256-302 **PM** series for High performance milling
PM Serie zum Hochleistungsfräsen
- B 303-396 **GM** series + DIN and ZCC CT Norm for Universal machining
GM Serie + DIN und ZCC CT Norm für allgemeine Bearbeitung
- B 397-450 **HM** series + DIN and ZCC CT Norm for hard materials machining
and high speed cutting
HM Serie + DIN und ZCC CT Norm für die Hartbearbeitung im HSC
Bereich
- B 451-463 **NM** series for machining copper
NM Serie für die Kupferbearbeitung
- B 464-496 **AL** series for machining aluminum alloy
AL Serie für die Bearbeitung von Aluminiumlegierungen
- B 497-530 **HPC** series for High performance machining
HPC Serie für die Hochleistungs-Bearbeitung
HPC-VSM series for machining of heat resistant super alloys
HPC-VSM Serie für die Bearbeitung von warmfesten Superlegierungen
- B 531-536** Technical information
Technische Informationen
Order form for non-standard products
Bestellformular für Sonderwerkzeuge

Milling · Fräsen

Solid Carbide end mills Overview · Vollhartmetallschaftfräser Übersicht

Machining · Bearbeitung	Shape Ausführung	Teeth · Zähne	Type Typ	Serie	Ø	material · Material										Page Seite	
						P		M	K	N		S	H		Specification Spezifikation	Cutting data Schnittdaten	
						Carbon steel alloy steel Kohlenstoff Stahl Legierter Stahl	Quenched and tempered steel Vergüteter Stahl	Stainless steel Rostfreier Stahl	Cast iron Grauguss	Copper alloy Kupfer Legierung	Aluminum alloy Alu Legierung	Heat resist. alloy Warmfeste Leg.	Hardened steel < 55HRC	Hardened steel gehärteter Stahl > 55HRC			
High performance milling · Hochleistungsfräsen	End mill Eckfräser	2	PM-2E		Ø1.0-Ø20.0	✓	✓	✓	✓			✓	✓	B264	B266		
			PM-2EL		Ø3.0-Ø20.0	✓	✓	✓	✓			✓	✓	B265	B266		
		4	PM-4E-G		Ø1.0-Ø20.0	✓	✓	✓	✓			✓	✓	B267	B272		
			PM-4EL-G		Ø3.0-Ø20.0	✓	✓	✓	✓			✓	✓	B268	B272		
			PM-4EX-G		Ø3.0-Ø20.0	✓	✓	✓	✓			✓	✓	B269	B273		
			PM-4E		Ø1.0-Ø20.0	✓	✓	✓	✓			✓	✓	B270	B274		
		PM-4EL		Ø3.0-Ø20.0	✓	✓	✓	✓			✓	✓	B271	B274			
		6	PM-6E		Ø6.0-Ø20.0	✓	✓	✓	✓			✓	✓	B275	B277		
	PM-6EL			Ø6.0-Ø20.0	✓	✓	✓	✓			✓	✓	B276	B278			
	Ball nose cutter Kugelkopf fräser	2	PM-2B		R0.5-R10.0	✓	✓	✓	✓			✓	✓	B279	B286-287		
			PM-2BL		R1.0-R10.0	✓	✓	✓	✓			✓	✓	B280	B286-287		
			PM-2BFP		R0.5-R10.0	✓	✓	✓	✓			✓	✓	B281	B286-287		
		4	PM-4B		R1.5-R10.0	✓	✓	✓	✓			✓	✓	B290	B292		
			PM-4BL		R1.5-R10.0	✓	✓	✓	✓			✓	✓	B291	B292		
	Ball nose cutter with conical neck Kugelkopf fräser mit konischem Hals	2	PM-2BC		R0.25-R2.0	✓	✓	✓	✓			✓	✓	B282-285	B288-289		
	Corner radius mills Radiuseck fräser	4	PM-2R		Ø1.0- Ø12.0	✓	✓	✓	✓			✓	✓	B293	B294		
			PM-4R		Ø3.0- Ø12.0	✓	✓	✓	✓			✓	✓	B295	B297		
	High feed cutter Hochvorschub-fräser	4	PM-4RL		Ø6.0- Ø16.0	✓	✓	✓	✓			✓	✓	B296	B297		
			PM-4H		Ø3.0- Ø12.0	✓	✓	✓	✓			✓	✓	B298	B300-301		
				PM-4HL		Ø4.0- Ø12.0	✓	✓	✓	✓			✓	✓	B299	B300-301	

















✓ = Very suitable · Sehr empfohlen
 ✓ = Suitable · Empfohlen

B

Solid Carbide end mills
 Vollhartmetallschaftfräser

Milling · Fräsen

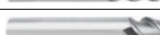
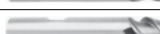
Solid Carbide end mills Overview · Vollhartmetallschaftfräser Übersicht

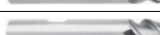
Machining · Bearbeitung	Shape Ausführung	Teeth · Zähne	NORM	Type Typ	Serie	Ø	material · Material						Page Seite		
							P	M	K	N	S	H	Specification Spezifikation	Cutting data Schnittdaten	
							Carbon steel alloy steel Kohlenstoff Stahl Legierter Stahl	Stainless steel · Rostfreier Stahl	Cast iron Grauguss	Copper alloy Kupfer Legierung	Aluminum alloy Alu Legierung	Heat resist. alloy Warmfeste Leg			Hardened steel gehärteter Stahl
General machining · Allgemeine Bearbeitung	End mill · Eckfräser	2	DIN	5501R302GM		Ø3.0-Ø20.0	✓	✓	✓				B304	B314-315	
				5601R302GM		Ø3.0-Ø20.0	✓	✓	✓					B305	B315
				5502R302GM		Ø3.0-Ø20.0	✓	✓	✓					B306	B316-317
				5602R302GM		Ø3.0-Ø20.0	✓	✓	✓					B307	B317
			GM-2E		Ø1.0-Ø20.0	✓	✓	✓					B308	B318	
			GM-2EL		Ø3.0-Ø20.0	✓	✓	✓					B309	B318	
			GM-2EX		Ø3.0-Ø20.0	✓	✓	✓					B310	B320	
			GM-2EFP		Ø6.0-Ø20.0	✓	✓	✓					B311	B321	
			GM-2F		Ø1.0-Ø20.0	✓	✓	✓					B312	B319	
			GM-2FL		Ø3.0-Ø20.0	✓	✓	✓					B313	B319	
			GM-3E		Ø1.0-Ø20.0	✓	✓	✓					B328	B339	
			GM-3EL		Ø3.0-Ø20.0	✓	✓	✓					B329	B339	
		3	DIN	5501R303GM		Ø3.0-Ø20.0	✓	✓	✓					B330	B336
				5601R303GM		Ø3.0-Ø20.0	✓	✓	✓					B331	B336
				5502R303GM		Ø3.0-Ø20.0	✓	✓	✓					B332	B337
				5602R303GM		Ø3.0-Ø20.0	✓	✓	✓					B333	B337
				5502R453GM		Ø3.0-Ø20.0	✓	✓	✓					B334	B338
				5602R453GM		Ø3.0-Ø20.0	✓	✓	✓					B335	B338





























✓ = Very suitable · Sehr empfohlen
 ✓ = Suitable · Empfohlen

B

Solid Carbide end mills
 Vollhartmetallschaftfräser

Milling · Fräsen

Solid Carbide end mills Overview · Vollhartmetallschaftfräser Übersicht

Machining · Bearbeitung	Shape Ausführung	Teeth · Zähne	NORM	Type Typ	Serie	Ø	material · Material						Page Seite			
							P	M	K	N	S	H	Specification Spezifikation	Cutting data Schnittdaten		
							Carbon steel alloy steel Kohlenstoff Stahl Legierter Stahl	Stainless steel Rostfreier Stahl	Cast iron Grauguss	Copper alloy Kupfer Legierung	Aluminum alloy Alu Legierung	Heat resist. alloy Warmfeste Leg			Hardened steel gehärteter Stahl	
General machining · Allgemeine Bearbeitung	End mill · Eckfräser	4	DIN	5501R304GF		Ø3.0-Ø20.0	✓	✓	✓				B348	B354		
				5601R304GF		Ø3.0-Ø20.0	✓	✓	✓						B349	B354
				5502R304GF		Ø3.0-Ø20.0	✓	✓	✓						B350	B356
				5602R304GF		Ø3.0-Ø20.0	✓	✓	✓						B351	B356
				5508R454GM		Ø3.0-Ø20.0	✓	✓	✓						B352	B355, 356
				5602R454GM		Ø3.0-Ø20.0	✓	✓	✓						B353	B355
			GM-4E-G		Ø1.0-Ø20.0	✓	✓	✓						B340	B357	
			GM-4F-G		Ø1.0-Ø20.0	✓	✓	✓						B341	B358	
			GM-4EL-G		Ø3.0-Ø20.0	✓	✓	✓						B342	B357	
			GM-4FL-G		Ø3.0-Ø20.0	✓	✓	✓						B343	B358	
			GM-4EX-G		Ø3.0-Ø20.0	✓	✓	✓						B344	B359	
			GM-4E		Ø1.0-Ø20.0	✓	✓	✓						B345	B360	
		GM-4EL		Ø3.0-Ø20.0	✓	✓	✓						B346	B360		
		GM-4EFP		Ø6.0-Ø20.0	✓	✓	✓						B347	B361		
		6	DIN	5589R45MGFR		Ø6.0-Ø20.0	✓	✓	✓					B362	B365	
				GM-6E		Ø6.0-Ø20.0	✓	✓	✓					B363	B366	
				GM-6EL		Ø6.0-Ø20.0	✓	✓	✓					B364	B367	
		Micro end mill Micro-fräser	2		GM-2EP		Ø0.5-Ø5.0	✓	✓	✓				B322	B325	
				GM-2ES		Ø0.3-Ø3.0	✓	✓	✓					B324	B327	
	Ball nose cutter · Kugelkopffräser	2	DIN	5565R302GF		Ø3.0-Ø16.0	✓	✓	✓				B368	B374		
				5665R202GM		Ø3.0-Ø20.0	✓	✓	✓					B369	B374	
				5566R302GF		Ø3-Ø12.0	✓	✓	✓					B370	B375	
			GM-2B		Ø1.0-Ø20.0	✓	✓	✓					B371	B376		
			GM-2BL		R1.0-R10.0	✓	✓	✓					B372	B376		
GM-2BFP				Ø1.0-Ø16.0	✓	✓	✓					B373	B381-382			
4			GM-4B		R1.5-R10.0	✓	✓	✓					B383	B385		
			GM-4BL		R1.5-R10.0	✓	✓	✓					B384	B385		
		Micro ball nose cutter Micro Kugelkopf fräser	2		GM-2BS		R0.15-R1.5	✓	✓	✓				B377	B380	
					GM-2BP		R0.25-R2.5	✓	✓	✓					B378	B381-382



























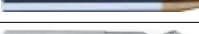
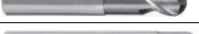
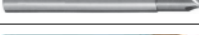



✓ = Very suitable · Sehr empfohlen
 ✓ = Suitable · Empfohlen

B

Solid Carbide end mills
 Vollhartmetallschaftfräser

Milling · Fräsen

























Solid Carbide end mills Overview · Vollhartmetallschaftfräser Übersicht

Machining · Bearbeitung	Shape Ausführung	Teeth · Zähne	NORM	Type Typ	Serie	Ø	material · Material						Page Seite		
							P	M	K	N	S	H	Specification Spezifikation	Cutting data Schmittdaten	
							Carbon steel alloy steel Kohlenstoff Stahl Legierter Stahl	Stainless steel · Rostfreier Stahl	Cast iron Grauguss	Copper alloy Kupfer Legierung	Aluminum alloy Alu Legierung	Heat resist. alloy Warmfeste Leg			Hardened steel gehärteter Stahl
General machining Allgemeine Bearbeitung	Corner radius end mill Radiuseckfräser	2		GM-2R		Ø1.0-Ø12.0	✓	✓	✓		✓		B386	B387	
		4		GM-4R		Ø3.0-Ø12.0	✓	✓	✓		✓		B388	B390	
				GM-4RL		Ø6.0-Ø16.0	✓	✓	✓		✓		B389	B390	
	Ripper Kordelfräser	4	DIN	5602R303/304GR		Ø10.0-Ø20.0	✓		✓		✓		B391	B393	
				5602R305GR		Ø10.0-Ø20.0	✓		✓		✓		B391	B393	
		4		GM-4W		Ø6.0-Ø20.0	✓		✓		✓		B392	B394-395	
			6		HM-4E		Ø1.0-Ø20.0			✓			✓	B409	B412
				HM-4EFP		Ø6.0-Ø20.0			✓			✓	B411	B413	
		HM-4EL			Ø3.0-Ø20.0			✓			✓	B410	B412		
	End mill Eckfräser	4	DIN	5502R55MHH		Ø3.0-Ø20.0			✓			✓	B414	B417	
6					HM-6E		Ø6.0-Ø20.0			✓			✓	B415	B418
					HM-6EL		Ø6.0-Ø20.0			✓			✓	B416	B419
			HM-2E		Ø1.0-Ø20.0			✓			✓	B399	B404		
Micro end mill Microfräser		6		HM-2EFP		Ø6.0-Ø20.0			✓			✓	B400	B405	
				HM-2EP		Ø0.5-Ø5.0			✓			✓	B401-402	B406-407	
				HM-2ES		Ø0.3-Ø3.0			✓			✓	B403	B408	
				5565R302GH		Ø3.0-Ø16.0			✓			✓	B420	B427	
Ball nose cutter Kugelkopf fräser		2	DIN	5566R302GH		Ø3.0-Ø12.0			✓			✓	B421	B428	
					HM-2B		R0.5-R10.0			✓			✓	B424	B431
	4	DIN	5565R302HH		Ø3.0-Ø16.0			✓			✓	B422	B429		
			5566R302HH		Ø3.0-Ø12.0			✓			✓	B423	B430		
			HM-2BL		R1.0-R10.0			✓			✓	B425	B431		
			HM-2BFP		R0.5-R10.0			✓			✓	B426	B431		
	4	DIN	5566R304HH		Ø6.0-Ø12.0			✓			✓	B438	B441		
				HM-4B		R1.5-R10.0			✓			✓	B439	B442	
				HM-4BL		Ø3.0-Ø20.0			✓			✓	B440	B442	
	Micro end mill Microfräser	2		HM-2BS		R0.15-R1.5			✓			✓	B432	B435	
			HM-2BP		R0.25-R2.5			✓			✓	B433-434	B436-437		
Corner radius mills Radiuseck fräser	4	DIN	5585R554HHR		Ø6.0-Ø16.0			✓			✓	B443	B448		
			5586R554HHR		Ø6.0-Ø16.0			✓			✓	B444	B449		
		HM-4R		Ø3.0-Ø12.0			✓			✓	B445	B450			
		HM-4RF		Ø6.0-Ø12.0			✓			✓	B446	B450			
		HM-4RP		Ø6.0-Ø16.0			✓			✓	B447	B450			

✓ = Very suitable · Sehr empfohlen
 ✓ = Suitable · Empfohlen

Milling · Fräsen

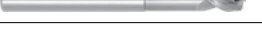
Solid Carbide end mills Overview · Vollhartmetallschaftfräser Übersicht

Machining · Bearbeitung	Shape Ausführung	Teeth · Zähne	NORM	Type Typ	Serie	Ø	material · Material						Page Seite		
							P	M	K	N	S	H	Specification Spezifikation	Cutting data Schnittdaten	
							Carbon steel alloy steel Kohlenstoff Stahl/ Legierter Stahl	Stainless steel Rostfreier Stahl	Cast iron Grauguss	Copper alloy Kupfer Legierung	Aluminum alloy Alu Legierung	Heat resist. alloy Warmfeste Leg			Hardened steel gehärteter Stahl
Machining copper Kupferbearbeitung	End mill Eckfräser	2	DIN	5502R402NM		Ø6.0-Ø20.0				✓			B452	B454	
				NM-2E		Ø1.0-Ø12.0				✓				B453	B455
		4	NM-4E		Ø3.0-Ø12.0				✓				B458	B459	
	Micro end mill Microfräser	2	DIN	NM-2EP		Ø0.5-Ø5.0				✓			B456	B457	
	Ball nose cutter Kugelkopffräs.			NM-2B		R0.5-R6.0				✓				B460	B461
				NM-2BP		R0.25-R2.5				✓				B462	B463
Machining aluminum Aluminium Bearbeitung	Micro end mill Microfräser		DIN	AL-1E		R2.0-R6.0				✓			B465	B466	
				AL-1E		R2.0-R6.0				✓				B465	B466
	End mill Eckfräser	2	DIN	AL-2E		Ø1.0-Ø20.0				✓			B467	B469	
				AL-2EL		Ø3.0-Ø20.0				✓				B468	B469
				ALG-2E		Ø1.0-Ø20.0				✓				B470	B471
				AL-3E		Ø1.0-Ø20.0				✓				B472	B474
		3	AL-3EL		Ø3.0-Ø20.0				✓				B473	B474	
			ALG-3E		Ø1.0-Ø20.0				✓				B475	B476	
			ALP-3E		Ø1.0-Ø20.0				✓				B477	B478	
			4	ALP-4E		Ø3.0-Ø20.0				✓				B479	B480
	Ball nose cutter Kugelkopffräs	2	DIN	5565R302NH		Ø3.0-Ø16.0				✓			B483	B486	
				5566R302NH		Ø3.0-Ø16.0				✓				B484	B487
	Ripper Kordelfräser	3		AL-2B		R1.0-R6.0				✓			B485	B488	
	High performance corner radius cutter High Performance Eckradius Fräser	2	DIN	AL-3W		Ø6.0-Ø20.0				✓			B481	B482	
				AL-2R-AIR		Ø6.0-Ø20.0				✓				B489	B491
3		AL-2RL-AIR		Ø6.0-Ø20.0				✓				B490	B492		
		AL-3R-AIR		Ø12.0-Ø20.0				✓				B493	B495		
			AL-3RL-AIR		Ø12.0-Ø20.0				✓			B494	B496		

✓ = Very suitable · Sehr empfohlen
 ✓ = Suitable · Empfohlen

B













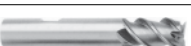



Solid Carbide end mills
 Vollhartmetallschaftfräser

Milling - Fräsen

Solid Carbide end mills Overview - Vollhartmetallschaftfräser Übersicht

B

Solid Carbide end mills
Vollhartmetallschaftfräser

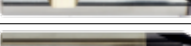
Machining · Bearbeitung	Shape Ausführung	Teeth · Zähne	NORM	Type Typ	Serie	Ø	material · Material						Page Seite		
							P	M	K	N	S	H	Specification Spezifikation	Cutting data Schmittdaten	
							Carbon steel alloy steel Kohlenstoff Stahl/Legierter Stahl	Stainless steel Rostfreier Stahl	Cast iron Grauguss	Copper alloy Kupfer Legierung	Aluminum alloy Alu Legierung	Heat resist. alloy Warmfeste Leg			Hardened steel gehärteter Stahl
HPC serie with unequal helix angle HPC Serie mit ungleichem Spiralwinkel	General machining Allgemeine Bearbeitung	4	DIN	5501R38414GM		HPC 38° / 41°	Ø4.0-Ø20.0	✓	✓	✓		✓		B501	B506-507
				5502R38414GM		HPC 38° / 41°	Ø4.0-Ø20.0	✓	✓	✓		✓		B502	B506-507
				5602R38414GM		HPC 38° / 41°	Ø4.0-Ø20.0	✓	✓	✓		✓		B503	B506-507
				5502R38414GM-R		HPC 38° / 41°	Ø4.0-Ø20.0	✓	✓	✓		✓		B504	B506-507
				5602R38414GM-R		HPC 38° / 41°	Ø4.0-Ø20.0	✓	✓	✓		✓		B505	B506-507
		UM-4E			Ø4.0-Ø20.0	✓	✓	✓		✓	✓	B508	B514-515		
		UM-4E-W			Ø4.0-Ø20.0	✓	✓	✓		✓	✓	B509	B514-515		
		UM-4EL			Ø4.0-Ø20.0	✓	✓	✓		✓	✓	B510	B514-515		
		UM-4EL-W			Ø4.0-Ø20.0	✓	✓	✓		✓	✓	B511	B514-515		
		UM-4ELP-W			Ø4.0-Ø20.0	✓	✓	✓		✓	✓	B512	B514-515		
	UM-4EFP			Ø6.0-Ø20.0	✓	✓	✓		✓	✓	B513	B516-517			
	UM-4R			Ø4.0-Ø20.0	✓	✓	✓		✓	✓	B518	B521-522			
	UM-4RL			Ø6.0-Ø16.0	✓	✓	✓		✓	✓	B519	B521-522			
	UM-4RFP			Ø6.0-Ø16.0	✓	✓	✓		✓	✓	B520	B523			
	Machining heat resistance super alloys Warmfeste Superlegierung Bearb.	4		VSM-4E		HPC 38° / 41°	Ø4.0-Ø20.0	✓	✓			✓		B524	B525
				VSM-4R		HPC 38° / 41°	Ø6.0-Ø12.0	✓	✓			✓		B526	B527
	Deburring Cutter Entgratfräser	3/4		5501/5601			Ø3.0-Ø16.0	✓	✓	✓	✓			B529	B530
				5501/5601			Ø3.0-Ø16.0	✓	✓	✓	✓			B529	B530
		4		5601			Ø5.6-Ø10.0	✓	✓	✓	✓			B530	B530

✓ = Very suitable · Sehr empfohlen
✓ = Suitable · Empfohlen

Grade introduction for solid carbide end mills Hartmetallsorten für VHM-Fräser

Coated Grades Beschichtete Sorten

KMG303

It is a combination of ultra-fine carbide substrate and Nano nc-AlTiN coating. It is a universal grade for milling of carbon steel, alloy steel (HRC<=48), cast iron and stainless steel.

Eine Kombination von Ultrafeinkorn-Hartmetall und Nano nc-AlTiN PVD-Beschichtung. Universelle Anwendung zum Fräsen von unlegiertem Stahl, legiertem Stahl (HRC<=48), Guss, rostfreiem Stahl.

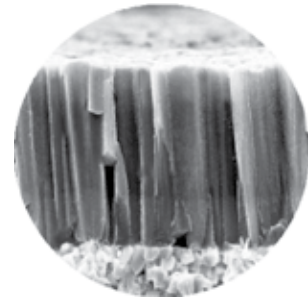

Common TiAlN coating
normale TiAlN Beschichtung

KMG405

It is a combination of ultra-fine carbide substrate of high strength, toughness and wear resistance with Nano AlTiN (TiAlN) or AlCrN coating and it is suitable for milling of stainless steel, Ti alloys, high-temperature alloys. High-strength materials. Alloy steel and cast iron. It is an optimal grade for the high speed milling of hardened materials (HRC 48-55).

Ultrafeinkorn-Hartmetall mit hoher Zugfestigkeit, Zähigkeit und Verschleißfestigkeit, plus Nano-AlTiN (TiAlN) oder AlCrN PVD-Beschichtung. Zum Hartfräsen und HSC-Fräsen von legiertem Stahl (HRC 48-55) und Guss. Sehr gut geeignet für die Bearbeitung von rostfreiem Stahl, Ti-Legierungen, warmfesten Superlegierungen.

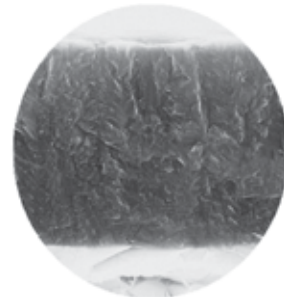

nc-AlTiN coating
nc-AlTiN Beschichtung

KMG555

It is an optimal combination of superfine carbide substrate of significantly higher wear resistance and high strength with HIPIMS technology. It is a special solution for high speed cutting, hard machining until HRC 70 and dry machining.

Superfeinkorn-Hartmetall mit deutlich höherer Verschleißfestigkeit und hoher Zugfestigkeit, plus HIPIMS Technologie. Sonderlösungen für HSC-Fräsen, Hartbearbeitung bis HRC 70 und Trockenbearbeitung.

KMG309

Grade with extremely high abrasive wear resistance coating. That makes the KMG309 the first choice for many non-ferrous material.

Sorte mit einer extrem abrasionsbeständigen Beschichtung. Das macht die KMG309 zur ersten Wahl bei der Bearbeitung von vielen NE-Metallen.

Uncoated Grades Unbeschichtete Sorten

YK30F

It is an ultra-fine carbide grade with good wear resistance and it is a universal grade for milling cutters.

Ultrafeinkorn-Hartmetall mit guter Verschleißfestigkeit. Universelle Sorte zum Fräsen

YK40F

It is an ultra-fine carbide grade with good wear resistance suitable for manufacturing milling cutters in the high speed milling of aluminium alloys.

Ultrafeinkorn-Hartmetall mit guter Verschleißfestigkeit. Geeignet für HSC-Fräser zur Aluminiumbearbeitung.

Milling - Fräsen

Solid Carbide end mills Code Key - Vollhartmetallschaftfräser ISO Kennzeichnung

DIN - STANDARD

Type of function Schneidenausführung	
code	Description Beschreibung
0	End mill Eckfräser
6	Ball nose end mill Kugelkopffräser
8	Radius end mill Fräser mit Eckradius

Helical alwinkel / Spiralwinkel			
00	0°	45	45°
20	20°	55	55°
30	30°	60	60°
3841	38°/41°		

Number of teeth Anzahl Zähne	
code	Description Beschreibung
2-4	Number of teeth Anzahl Zähne
M	It is indicated by M when the same type is with different sizes and number of teeth. Wird angegeben, wenn verschiedene Durchmesser verschiedene Zähnezahlen haben.

Type of tools Werkzeugtype	
code	Description Beschreibung
5	End mills / Fräser

Direction of rotation Drehrichtung	
code	Description Beschreibung
R	Right hand / Rechts
L	Left hand / Links

Radius Radius	
code	Description Beschreibung
R05	Radius: 0.5 mm Radius

Diameter Durchmesser	
code	Description Beschreibung
0800	8.0 mm in diameter Durchmesser: 8.0mm



Type of shank Schaftausführung	
code	Description · Beschreibung
1	Shank · Schaft
5	DIN 6535 HA
6	Weldon DIN 6535 HB
7	Whistel-Notch DIN 6535 HE
9	Taper shank · Morsekegel

Tool shape Ausführung	
code	Description · Beschreibung
1	DIN 6527 K
2	DIN 6527 L
5	As per ZCC-A in QJ ZZQ(TQ)01.002.002 between the radius and the specification Nach Werksnorm ZCC-A
6	As per ZCC-B in QJ ZZQ(TQ)01.002.002 between the radius and the specification Nach Werksnorm ZCC-B
8	DIN 6528
9	As per ZCC-D in QJ ZZQ(TQ)01.002.002 between the radius and the specification Nach Werksnorm ZCC-D

Machining Bearbeitung	
code	Description · Beschreibung
GR	General roughing Allgemeine Schruppbearbeitung
NR	Roughing machining of nonferrous metals Schruppen von NE-Metallen
GM	General semi-finishing Allgemeine mittlere Bearbeitung
SR	Machining of Ti alloys and Heat resist. alloys Zur Bearbeitung von Ti-Legierungen und wärmefesten Materialien
GF	General finishing Allgemeine Schlichtbearbeitung
NH	High speed machining of nonferrous Metals Hochgeschwindigkeitsbearb. von NE-Metallen
NM	Semi-finishing of nonferrous Metals Mittlere Bearb. von NE-Metallen
HH	High speed machining of hardened materials Hochgeschwindigkeitsbearbeitung von gehärtetem Material (HRC: 52-65)
GH	High speed machining of general material Hochgeschwindigkeitbearb. von Stahl
PR	Roughing of steel Schruppbearbeitung von Stahl
HM	For machining high-hardness steel Zur Bearbeitung von gehärtetem Stahl
PM	High performance end mills Hochleistungsfräser
UM	High performance solide carbide endmills Hochleistungs-VHM-Fräser

B

Solid Carbide end mills
Vollhartmetallschaftfräser

Graphics identification and application Graphische Werkzeug- und Anwendungsbeschreibung

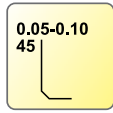

Cylindrical flattened tool nose
Eckenschutzfase

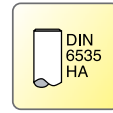

DIN6535HA straight shank
DIN6535HA Zylinderschaft



R end mill nose
Eckenradius



DIN6535HB weldon
DIN6535HB Weldonspannfläche



Ball nose end mills
Vollradius

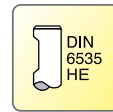

DIN6535HE whistle notch shank
DIN6535HE mit whistle notch Spannfläche

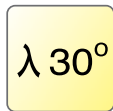

30° helical angle
30° Spiralwinkel

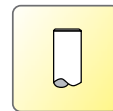

Straight shank
Zylinderschaft

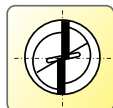

2-tooth mill for center milling with
one teeth overpass the center
2-Zähne, ein Zahn über Mitte



Square and straight shank
Zylinderschaft mit Vierkant

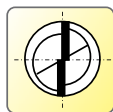

2-tooth mill for center milling
2-Zähne mit Zentrumschnitt

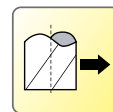

Radial feed
Radiale Bearbeitung



3-tooth mill for center milling with one
teeth overpass the center
3-Zähne, ein Zahn über Mitte

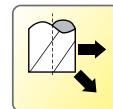

Radial, aslant feed compensated with
helical cutting
Bearbeitung: radial, Spiralinterpolation

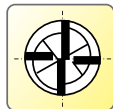

4-tooth mill for center milling
4-Zähne mit Zentrumschnitt

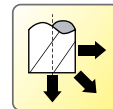

Radial, aslant feed compensated with helical cutting
Bearbeitung: radial, Spiralinterpolation, Eintauchen

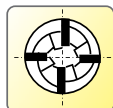

4-tooth mill not for center milling
4-Zähne stirnseitig im Zentrum frei

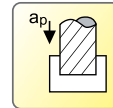

Groove milling
Nutenfräsen

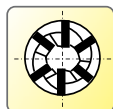

Mills with 6 teeth and above not for
center milling
6-Zähne oder mehr stirnseitig im
Zentrum frei

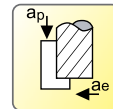

Side milling
Eckfräsen, Umfangfräsen

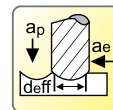

Profile milling
Profilfräsen

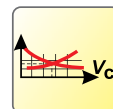

Cutting Data
Schnittdaten

Milling - Fräsen

Solid Carbide end mills Code Key - Vollhartmetallschaftfräser ISO Kennzeichnung

JM - SERIE

Machining Bearbeitung	
GM	Universal machining Allgemeine Bearbeitung
PM	High performance milling Hochleistungsfräsen
HM	For hard materials machining and high speed cutting Zur Hartbearbeitung im HSC Bereich
NM	For copper and nonferrous metals machining Zur Bearbeitung von Kupfer und NE-Metallen
AL	For aluminum alloy machining Zur Bearbeitung von Aluminiumlegierungen
VSM	For machining of heat resistant super alloys Zur Bearbeitung von wärmefesten Superlegierungen
UM	Universally applicable for machining of various materials with high cutting performance and a high surface quality. Universell einsetzbar für die Bearbeitung von unterschiedlichen Materialien mit hoher Zerspanungsleistung und einer hohen Oberflächengüte.

Type of function Schneidenausführung	
E	End mill with cutting edge protection Eckfräser mit Schneidschutz
F	End mill with sharp cutting edge Eckfräser mit scharfen Schneidkanten
B	Ball nose end mill Kugelpkopfräser
R	Radius end mill Fräser mit Eckenradius
W	End mills Kordel geometrie Eckfräser Kordel Geometrie
H	High feeding Hochvorschub

S	Tiny diameter Micro-Durchmesser
P	Shrunk neck Abgesetzter Hals
C	Conical neck Konischer Hals

Radius Radius

GM -2 E L P -D12 R0.5 -M08

Number of teeth
Anzahl der Zähne

Diameter
Durchmesser

Tool shape Ausführung	
L	Long series · Lange Serie
X	Extral long Extral Lange
F	Short cutting edge Kurze Schneidenlänge
	Series of standard length Standardlänge Serie



Special size instruction Spezielle Baumaße	
G	4-teeth end mills with 30° helical angle 4-Zähne Fräser mit Spiral Winkel 30°
M	Neck length Halslänge
H	Cutting edge length Schneidenlänge
L	Whole length Gesamtlänge
D	Diameter Durchmesser
S	Slim shank (ø 4mm) Schmale Ausführung
AIR	Extra high speed end mills for machining aluminum in aerospace industry High-Speed Fräser für Luftfahrtindustrie

B





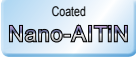



Solid Carbide end mills
Vollhartmetallschaftfräser

Graphics identification and application Graphische Werkzeug- und Anwendungsbeschreibung

Coated end mills Beschichtete VHM Fräser

	Nano-AlTiN coating Nano-AlTiN Beschichtung
	TiAlN coating TiAlN Beschichtung
	CrN coating CrN Beschichtung

End mill series VHM Fräser Serie

	2-flute end mills 2-Schneiden Eckfräser
	2-flute ball nose end mills 2-Schneiden Kugelkopffräser
	2-flute R end mills 2-Schneiden Radiuseckfräser
	3-flute end mills 3-Schneiden Eckfräser
	3-flute R end mills 3-Schneiden Radiuseckfräser
	4-flute end mills 4-Schneiden Eckfräser
	4-flute ball nose end mills 4-Schneiden Kugelkopffräser
	4-flute R end mills 4-Schneiden Radiuseckfräser
	6-flute end mills 6-Schneiden Eckfräser

Helical angle Spiral Winkel

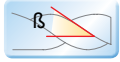
	helical angle Spiral Winkel 30°, 45°, 55°
---	--







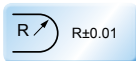



Cutter diameter tolerance Fräserdurchmesser Toleranz

	Cutter diameter tolerance Fräserdurchmesser Toleranz
---	---



Radius tolerance of ball nose end mills Radius Toleranz von Kugelkopffräsern

	Radius tolerance Radius Toleranz
---	-------------------------------------

Machining operation Bearbeitungsform

	side face machining Schulterfräsen
	shoulder machining Eckfräsen
	straight slot machining Nutenfräsen
	deep slot machining Nutenfräsen (tief)
	profile machining Profilfräsen
	cavity machining Auskammern
	slot machining (round) Nutenfräsen (rund)
	deep slot machining (deep, round) Nutenfräsen (tief, rund)
	side machining with radius Radius Eckfräsen
	slot machining with radius Nutenfräsen mit Radius

Cutting edge

	Cutting edge with protection Schneidkante mit Schutzfase
	Sharp cutting edge scharfe Scharfe Schneidkante

High performance end mills Hochleistungsfräser

PM

Application in machining of steel
Anwendung in Bearbeitung von Stahl

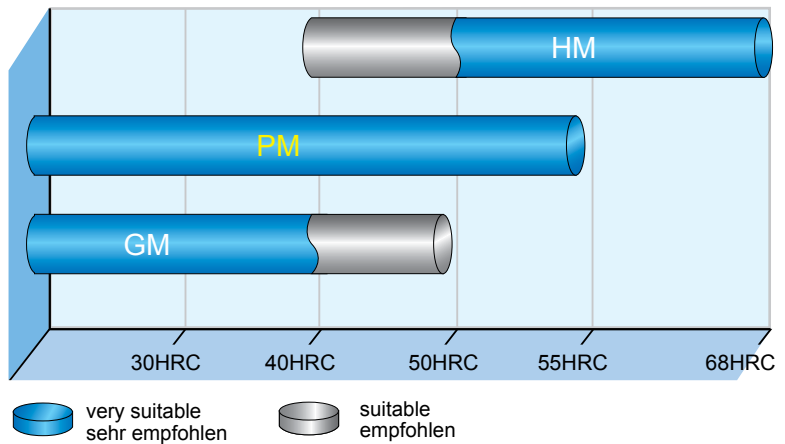

**Optimal geometry, improving chips flow.
Optimierte Geometrie für guten Spanfluß.**

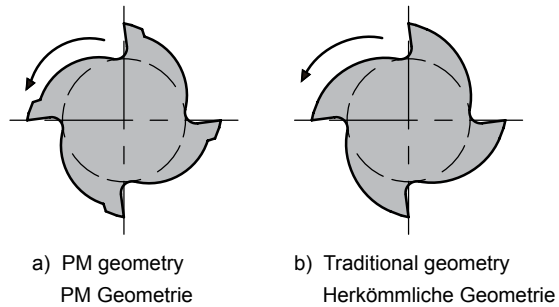

Stabile cutting edge and high rigid, improving feed rate F_z and machining efficiency.

Eine stabile Schneidkante mit hoher Steifigkeit erhöht die Vorschubwerte und die Auslastung der Maschine.

Diameter / Durchmesser: $\varnothing 6.0\text{mm}$
 Type / Typ: a) PM-4E-D6.0
 b) Tools of company A
 Machine Tools /
 Werkzeug Wettbewerber: Mikron UCP1000
 Material: NAK80(40HRC)
 Cooling / Kühlung : air cooling / Luft
 Operation: side milling / Eckfräsen
 Cutting data / Schnittdaten: $V_c=100\text{m/min}$
 $a_p=9\text{mm}$
 $a_e=0.6\text{mm}$
 $F_z=0.04\text{mm}\sim 0.16\text{mm}$

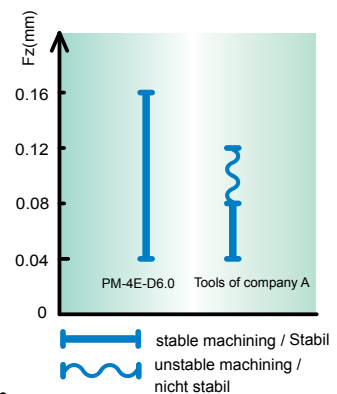

PM geometry in combination of high wear resistance and toughness, better tool life and against cutting edge breakage.
 PM Geometrie mit einer Kombination aus Verschleißfestigkeit und Zähigkeit, für ausgezeichnete Standzeiten und Schneidkantenstabilität.

Type / Typ: PM-4E-D6.0
 Diameter / Durchmesser: Ø6.0mm
 Material: NAK80(40HRC)
 Cutting speed / Schnittgeschw.: 5300r/min (100m/min)
 Feed rate / Vorschub: 1696mm/min (0.32mm/r)

Axial cutting depth /
 Axiale Zustellung: $a_p=9\text{mm}$
 Radial cutting depth /
 Radiale Zustellung: $a_e=0.6\text{mm}$
 Operation: side milling / Eckfräsen
 Cooling / Kühlung: air cooling / Luft
 Machine / Maschine: MIKRON
 UCP1000

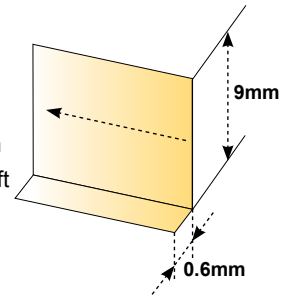

Results / Ergebnis

Machining time Bearbeitungszeit	50 min			
Wear Verschleiß				
Type Typ	PM-4E-D6.0	A company's tools Werkzeug Firma A	B company's tools Werkzeug Firma B	PM-4E-D6.0

PM-4E-D6.0-G high speed cutting NAK 80 PM-4E-D6.0-G High Speed Fräsen NAK 80:

Type / Typ: PM-4E-D6.0-G
 Diameter / Durchmesser: Ø6.0mm
 Material: NAK80(40HRC)
 Cutting speed /
 Schnittgeschw.: 13260r/min (250m/min)
 Feed rate /
 Vorschub: 2652mm/min(0.2mm/r)
 Axial cutting depth /
 Axiale Zustellung: $a_p=6\text{mm}$
 radial cutting depth /
 Radiale Zustellung: $a_e=0.3\text{mm}$
 Operation: side milling / Eckfräsen
 Cooling / Kühlung: air cooling / Luft
 Machine / Maschine: MIKRON HSM800

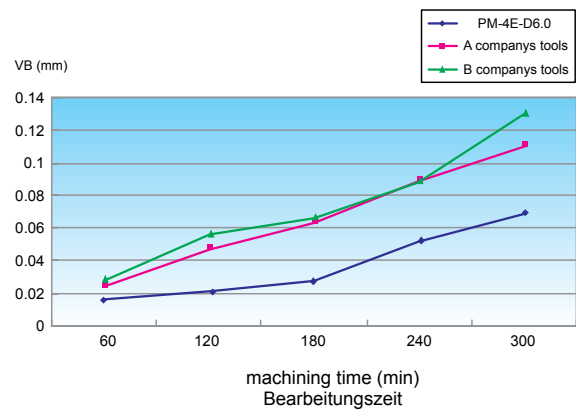
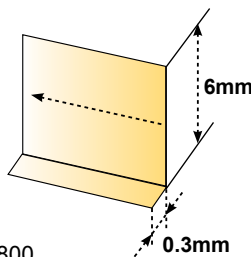

PM-4E-D8.0 efficient machining of alloy steel PM-4E-D8.0 Effizientes Bearbeiten von legiertem Stahl

Machine / Maschine: MIKRON UCP1000
 Shank / Schaft: HSK63-A
 Material: alloy steel
 Cutting speed /
 Schnittgeschw.: 100(m/min)
 Feed rate
 Vorschub: 0.04(mm/teeth)
 Axial cutting depth
 Axiale Zustellung: 8mm
 Radial cutting depth /
 Radiale Schnittgeschw. (mm): 0-8mm
 Cooling / Kühlung: liquid / Emulsion
 Operation: profil machining / Konturfräsen

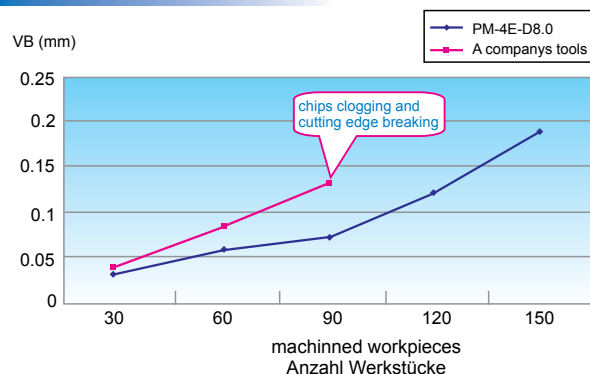

PM-2BC

" Pencil neck cutting tools "

" Kugelfräser mit konischem Schaft "

- For high rigidity and accurate machining with different taper angle
- Hohe Steifigkeit und hohe Genauigkeit mit unterschiedlichen Kugelwinkeln

High radius accuracy
Hohe Genauigkeit

Conical neck for better rigidity
Konischer Schaft für mehr Steifigkeit

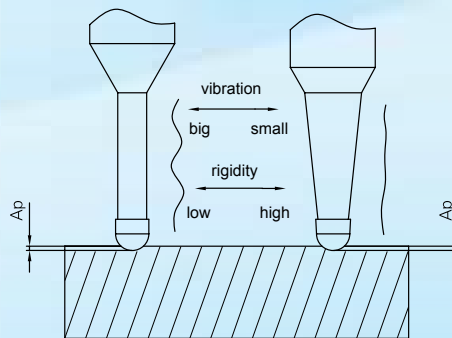

Nano structure coating
Nano-Ti ALN Beschichtung

Combination of ultra-fine carbide substrate of good wear resistance and toughness
Kombination aus Ultrafeinkorn Substrat für hohe Verschleißfestigkeit und Zähigkeit

PM-2BC15-R0.25-M05

Material: NAK80(40HRC)
 Rotation / Drehzahl =30000rpm/min
 Feed rate /Vorschub=300mm/min
 Axial cutting depth /Axiale Zustellung: $a_p=0.03\text{mm}$
 Radial cutting depth / Radiale Zustellung : $a_e=0.03\text{mm}$
 Operation: contour machining / Konturfräsen
 Cooling / Kühlung : liquid cooling / Emulsion
 Machine / Maschine: MIKRON UCP1000

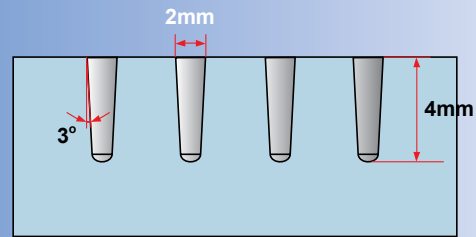

Type Typ	PM-2BC15-R0.25-M05 (conical neck / Konischer Hals) R0.25×1.5°×5	R0.25×5 (cylindrical neck / Zylindrischer Hals)
Result Ergebniss	tool life > 160 min Standzeit > 160 min	tool life until 90 min and cutting tools breaking Standzeit unter 90 min und Werkzeugbruch

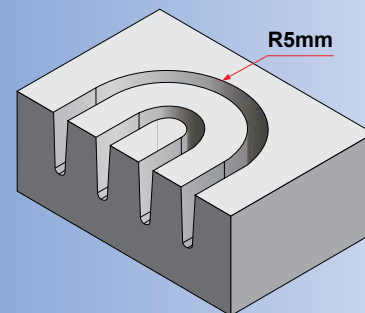

Conical angle and feed rate / Konischer Winkel und Vorschub

Type / Typ:

1. PM-2BC05-R0.25-M05(conical neck / Konischer Hals)
R0.25×0.5°×5
2. PM-2BC10-R0.25-M05(conical neck / Konischer Hals)
R0.25×0.5°×5
3. PM-2BC15-R0.25-M05(conical neck / Konischer Hals)
R0.25×0.5°×5
4. R0.25×5 (cylindrical neck / Zylindrischer Hals)

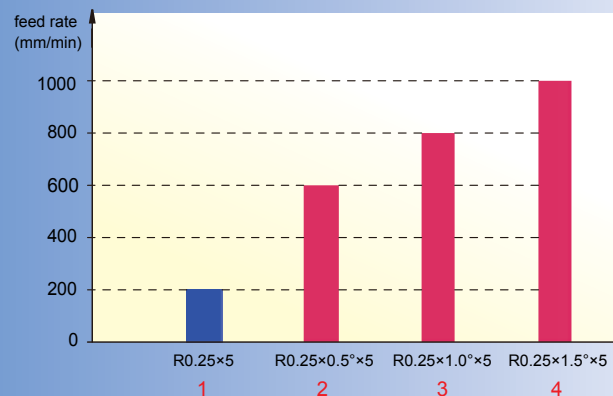

Material: NAK80(37HRC)

Cutting speed / Schnittgeschwindigkeit : 30000r/min
 Axial cutting depth / Axiale Zustellung: $a_p=0.15\text{mm}$
 Radial cutting depth / Radiale Zustellung: gerade Linien
 Cooling / Kühlung: air cooling / Luft
 Machine / Maschine: MIKRON UCP1000

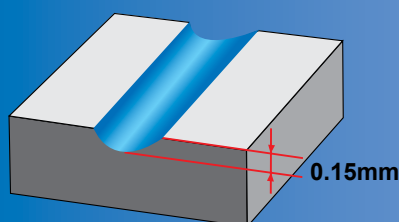



For effective roughing
Für effektive Schruppbearbeitung

PM-4H

High feed end mills
Hochvorschubfräser

Stabile shaft
Stabiler Schaft

Conical and reduced neck
Konisch freigeschliffen

Short cutting edge with high
rigidity for less vibration
Kurze Schneiden mit hoher
Steifigkeit zur Reduzierung von
Vibrationen

PM-4H-D8.0R2.0

Type / Typ: PM-4H-D8.0R2.0
 Diameter / Durchmesser: Ø8.0mm
 Material: NAK80(40HRC)
 n: 3980r/min
 V c : 100m/min
 fn: 9550mm/min
 fz: 0.6mm/z
 a_p = 0.2mm
 a_e = 4mm
 Operation: line milling / Bahnenfräsen
 Cooling / Kühlung: air cooling / Luft
 Machine / Maschine: MIKRON UCP1000
 Tool over hang / Auskraglänge : 32mm

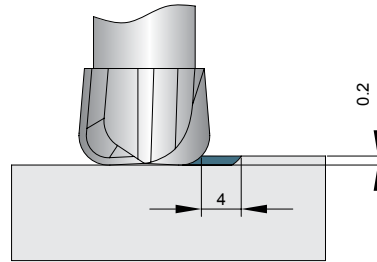

Tool life / Standzeit : > 800m

PM-4H-D8.0R2.0

Type / Typ: PM-4H-D8.0R2.0
 Diameter / Durchmesser: Ø8.0mm
 Material: NAK80(40HRC)
 n: 5970r/min
 V c : 150m/min
 f n : 7160mm/min
 fz: 0.3mm/z
 a_p = 0.2mm
 a_e = 4mm
 Operation: milling of pocket / Taschenfräsen
 Cooling / Kühlung: air cooling / Luft
 Machine / Maschine: MIKRON UCP1000
 Tool over hang / Auskraglänge : 32mm

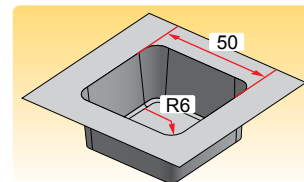
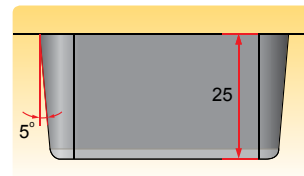

PM-4H-D6.0R1.5

Type and / Typ und
 tool over hang / Auskraglänge
 1. PM-4H-D6.0R1.5 tool over hang: 24mm
 2. PM-4HL-D6.0R1.5 tool over hang: 48mm
 Diameter / Durchmesser: Ø6.0mm
 Material: NAK80(40HRC)
 V c : 50~100m/min
 fz: 0.25mm/z
 a_p = 0.2mm
 a_e = 2mm
 Operation: line milling / Bahnenfräsen
 Cooling / Kühlung: air cooling / Luft
 Machine / Maschine: MIKRON UCP1000

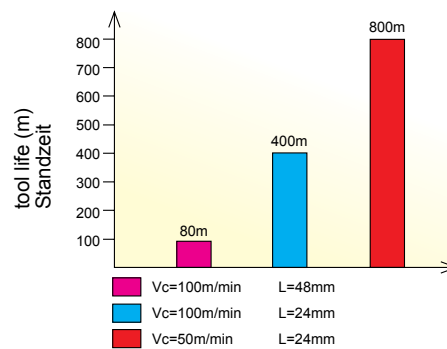

High precision profiling
Hochpräzisions-Profilfräsen

Ballnose end mills with two teeth Kugelfräser mit zwei Schneiden

PM-2B PM-2BL PM-2BFP

- Perfect crossing of cutting edges, getting good surface quality.
- Perfekte Form der Schneidengeometrie für gute Oberflächenqualität.

Type / Typ: PM-2B-R3.0
 Diameter / Durchmesser: Ø6.0mm
 Material: NAK80(40HRC)
 n: 10600r/min (200m/min)
 f n : 2120mm/min (0.2mm/r)
 $a_p = 0.2\text{mm}$
 $a_e = 0.3\text{mm}$
 Operation: Milling / Fräsen
 Cooling: air cooling / Luft
 Machine / Maschine: MIKRON UCP1000
 Tool over hang / Auskräglänge 20mm
 Surface quality measuring /
 Oberflächenqualitäts-Messung: TM2000



- Updated coating technology.
- Verbesserte Beschichtung.

- High rigid tool structure, reducing vibration.
- Hohe Steifigkeit zur Reduzierung von Vibrationen.

- Ultra - fine carbide substrate.
- Ultrafeinkorn-Substrat.

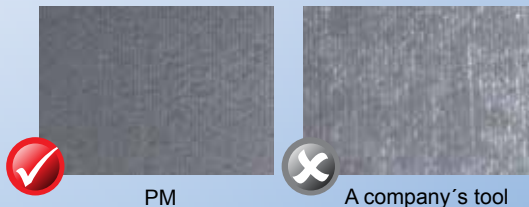
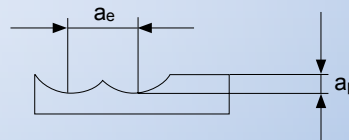

PM ballnose endmills can get clear working route with good surface quality.

PM Kugelfräser erreichen eine definierte Kugelbahnnut mit guter Oberflächengüte.

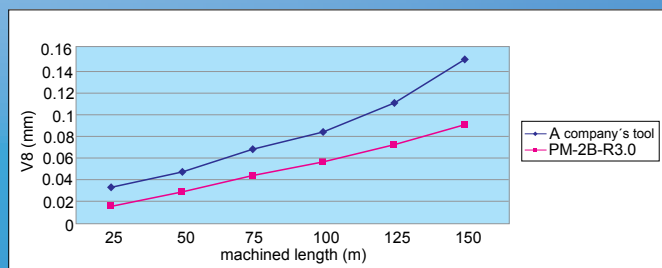
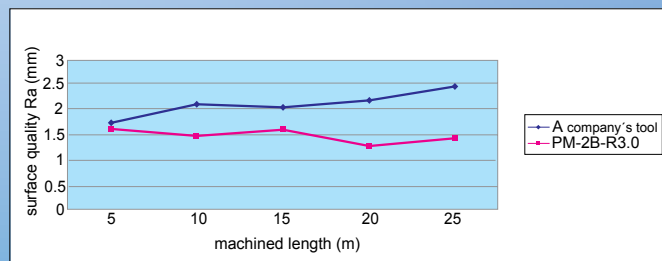

PM-4B PM-4BL

Ballnose end mills with four teeth
Kugelfräser mit vier Schneiden
 High precision profil milling
 Hoch-Präzisions-Profilfräsen

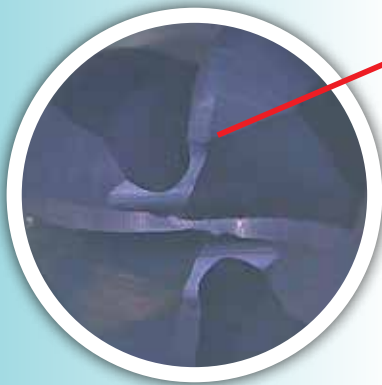

The ball center is in combination of strong and sharp cutting edge.
 Das Kugelzentrum ist eine Kombination aus scharfen Schneidkanten und großer Steifigkeit.



The application of high performance 4-flutes ballnose end mills.
 Anwendungsfall Kugelfräser mit vier Schneiden.



Type / Typ: PM-4B-R5.0
 Diameter / Durchmesser: Ø10.0mm
 Material: Cr12(36HRC)
 n: 2800r/min (88m/min)
 fn: 3000 mm/min
 $a_p = 1\text{mm}$
 $a_e = 0.6\text{mm}$
 Operation: Profiling
 Cooling / Kühlung: air cooling / Luft
 Machine / Maschine: Xiehong CNC-1600
 Tool over hang / Auskraglänge: 45mm
 Clamping of workpieces /
 Werkstückklemmung: SafeWay CV-200V
 Tooling system /
 Werkzeugsystem: BT50-ER40-100

Number of machined workpiece Anzahl Werkstück	5 pcs (150min)	2 pcs (60min)
Wear Verschleiß		
Tools type Werkzeug	PM-4B-R5.0	A company's tools Wettbewerber A
Result Ergebnis	It's less wears after machining 5 workpieces and it can be continued. Geringerer Verschleiß nach 5 Bauteilen. Weiterer Einsatz möglich.	The breakage on center the of ballnose tools after machining two workpieces. Schneidenbruch im Zentrum nach 2 Bauteilen.

Milling · Fräsen

Solid Carbide end mills · Vollhartmetallschaftfräser

2-flute flattened end mills with straight shank 2-Schneiden Eckfräser mit Zylinderschaft



PM-2E

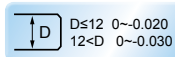
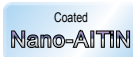
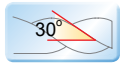
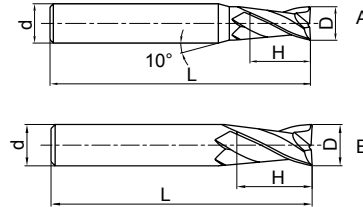

Type Typ	Dimension(mm) Abmessungen				Teeth Zähne Z	Geometry Ausführung	Grade Sorte KMG 405
	D	d	H	L			
PM-2E-D1.0S	1.0	4	3	50	2	A	●
PM-2E-D1.5S	1.5	4	4	50	2	A	●
PM-2E-D2.0S	2.0	4	6	50	2	A	●
PM-2E-D2.5S	2.5	4	8	50	2	A	●
PM-2E-D3.0S	3.0	4	8	50	2	A	●
PM-2E-D4.0S	4.0	4	11	50	2	B	●
PM-2E-D1.0	1.0	6	3	50	2	A	●
PM-2E-D1.5	1.5	6	4	50	2	A	●
PM-2E-D2.0	2.0	6	6	50	2	A	●
PM-2E-D2.5	2.5	6	8	50	2	A	●
PM-2E-D3.0	3.0	6	8	50	2	A	●
PM-2E-D3.5	3.5	6	10	50	2	A	●
PM-2E-D4.0	4.0	6	11	50	2	A	●
PM-2E-D4.5	4.5	6	11	50	2	A	●
PM-2E-D5.0	5.0	6	13	50	2	A	●
PM-2E-D5.5	5.5	6	16	50	2	A	●
PM-2E-D6.0	6.0	6	16	50	2	B	●
PM-2E-D7.0	7.0	8	20	60	2	A	●
PM-2E-D8.0	8.0	8	20	60	2	B	●
PM-2E-D9.0	9.0	10	22	75	2	A	●
PM-2E-D10.0	10.0	10	25	75	2	B	●
PM-2E-D11.0	11.0	12	26	75	2	A	●
PM-2E-D12.0	12.0	12	30	75	2	B	●
PM-2E-D14.0	14.0	14	32	75	2	B	●
PM-2E-D16.0	16.0	16	45	100	2	B	●
PM-2E-D18.0	18.0	18	45	100	2	B	●
PM-2E-D20.0	20.0	20	45	100	2	B	●

Material Overview · Material Übersicht

✓ = Very suitable · Sehr empfohlen
 ✓ = Suitable · Empfohlen

KMG405

		Workpiece material Werkstückstoff									
Carbon steel Kohlenstoff Stahl	Alloy steel Legierter Stahl	Quenched and tempered steel · Vergüteter Stahl		Hardened steel · Gehärteter Stahl		Stainless steel · Rostfreier Stahl	Cast iron, Nodular cast iron Grauguss GGG	Copper alloy Kupfer Leg	Aluminum alloy Alu Leg	Titanium alloy Titan Leg	Heat resist alloy warmfeste Leg
		~40HRC	~50HRC	~55HRC	~68HRC						
✓	✓	✓	✓	✓	✓	✓	✓			✓	✓

● Ex Stock / ab Lager ○ On demand / auf Anfrage

2-flute flattened end mills with straight shank and long cutting edge
2-Schneiden Eckfräser mit langer Schneide und Zylinderschaft



PM-2EL

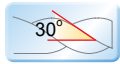
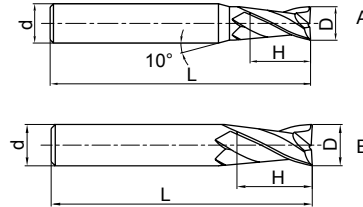
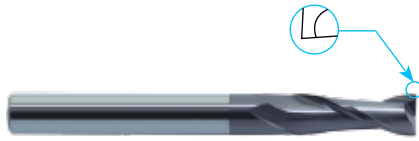

Coated
Nano-AITIN

D ≤ 12 0~-0.020
12 < D 0~-0.030



Type Typ	Dimension (mm) Abmessungen				Teeth Zähne Z	Geometry Ausführung	Grade Sorte KMG 405
	D	d	H	L			
PM-2EL-D3.0	3.0	6	12	75	2	A	●
PM-2EL-D4.0	4.0	6	15	75	2	A	●
PM-2EL-D5.0	5.0	6	20	75	2	A	●
PM-2EL-D6.0	6.0	6	20	75	2	B	●
PM-2EL-D8.0	8.0	8	25	100	2	B	●
PM-2EL-D10.0	10.0	10	30	100	2	B	●
PM-2EL-D12.0	12.0	12	35	100	2	B	●
PM-2EL-D14.0	14.0	14	40	100	2	B	●
PM-2EL-D16.0	16.0	16	50	150	2	B	●
PM-2EL-D20.0	20.0	20	55	150	2	B	●

B

Solid Carbide end mills
Vollhartmetallschaftfräser

Material Overview · Material Übersicht

✓ = Very suitable · Sehr empfohlen
✓ = Suitable · Empfohlen

KMG405

Workpiece material Werkstückstoff											
Carbon steel Kohlenstoff Stahl	Alloy steel Legierter Stahl	Quenched and tempered steel · Vergüteter Stahl		Hardened steel · Gehärteter Stahl		Stainless steel · Rostfreier Stahl	Cast iron, Nodular cast iron Grauguss GGG	Copper alloy Kupfer Leg	Aluminum alloy Alu Leg	Titanium alloy Titan Leg	Heat resist alloy warmfeste Leg
		~40HRC	~50HRC	~55HRC	~68HRC						
✓	✓	✓	✓	✓	✓	✓	✓			✓	✓

Code key B252,B254
ISO Kennzeichen

Cutting data B266
Schnittdaten

Graphics identification & application B253-B255
Graphische Werkzeug- & Anwendungsbeschr.

Order form for non-standard products B534-B535
Bestellformular für Sonderwerkzeuge

B265

Milling · Fräsen

Solid Carbide end mills · Vollhartmetallschaftfräser

Recommended cutting data · Empfohlene Schnittdaten

PM-2E | PM-2EL

Workpiece material Werkstückmaterial	Cast iron, Carbon steel, Alloy steel Kohlenstoffstahl Leg. Stahl ~30HRC		Stainless steel Rostfreier Stahl		Pre-hardened steel, Quenched and tempered steel Vergüteter Stahl ~40HRC		Pre-hardened steel, Quenched and tempered steel Vergüteter Stahl ~50HRC		Hardened steel Gehärteter Stahl ~55HRC	
	Diameter Ø Durchmesser (mm)	Rotating Drehzahl (min ⁻¹)	Feed Vorschub (mm/min)	Rotating Drehzahl (min ⁻¹)	Feed Vorschub (mm/min)	Rotating Drehzahl (min ⁻¹)	Feed Vorschub (mm/min)	Rotating Drehzahl (min ⁻¹)	Feed Vorschub (mm/min)	Rotating Drehzahl (min ⁻¹)
1	20000	200	20000	60	20000	165	20000	120	20000	90
2	15000	320	11150	85	15000	285	13000	180	11140	130
3	14000	545	7500	120	10600	420	8500	330	7430	240
4	10800	560	5500	135	8000	425	6500	335	5570	245
5	8200	585	4500	135	6400	445	5000	355	4460	260
6	7000	600	3700	140	5300	465	4200	360	3710	260
8	5200	595	2800	140	4000	455	3200	365	2785	270
10	4200	585	2200	140	3200	445	2500	350	2230	250
12	3500	585	1850	140	2650	445	2100	350	1855	250
14	3000	545	1600	135	2300	420	1800	330	1590	240
16	2600	545	1400	120	2000	420	1600	330	1390	240
18	2300	535	1250	120	1800	415	1400	325	1240	235
20	2050	535	1100	120	1600	415	1250	325	1115	235

Max. cutting depth max Schnitttiefe	Side milling		Slot milling											
	Diagram	Table	Diagram	Table										
				<table border="1"> <thead> <tr><th>Milling slot</th><th>Nutenfräsen</th></tr> <tr><th>Ø</th><th>Ap</th></tr> </thead> <tbody> <tr><td>Ø1≤D<Ø3</td><td>0.15D</td></tr> <tr><td>Ø3≤D<Ø6</td><td>0.3D</td></tr> <tr><td>Ø6≤D<Ø20</td><td>0.5D</td></tr> </tbody> </table>	Milling slot	Nutenfräsen	Ø	Ap	Ø1≤D<Ø3	0.15D	Ø3≤D<Ø6	0.3D	Ø6≤D<Ø20	0.5D
	Milling slot	Nutenfräsen												
Ø	Ap													
Ø1≤D<Ø3	0.15D													
Ø3≤D<Ø6	0.3D													
Ø6≤D<Ø20	0.5D													
				<table border="1"> <thead> <tr><th>Milling slot</th><th>Nutenfräsen</th></tr> <tr><th>Ø</th><th>Ap</th></tr> </thead> <tbody> <tr><td>Ø1≤D<Ø3</td><td>0.1D</td></tr> <tr><td>Ø3≤D</td><td>0.2D</td></tr> </tbody> </table>	Milling slot	Nutenfräsen	Ø	Ap	Ø1≤D<Ø3	0.1D	Ø3≤D	0.2D		
Milling slot	Nutenfräsen													
Ø	Ap													
Ø1≤D<Ø3	0.1D													
Ø3≤D	0.2D													

- The above table shows the standard value of side milling. When slot milling, of rotating speed 50%~70% and feed rate like mentioned above 40%~60%.
- Please select high precise machine and tool holder.
- Please use air blow or cutting liquid with high mist retardant property.
- Down milling is recommended in side milling.
- Vibration and unusual noise may be generated if the machine rigidity and workpiece fixture stability is low, please reduce the rotating speed and feed rate like mentioned above.
- Make overhang as short as possible if no interference.

- Die obige Tabelle zeigt Standard Werte für das Eckfräsen. Bei Nutenfräsen, Schnittgeschwindigkeit auf 50-70% und den Vorschub auf 40-60% reduzieren.
- Bitte präzise Maschinen und Werkzeughalter verwenden.
- Bitte Luftkühlung oder Schneidflüssigkeit benutzen.
- Empfohlene Fräsmethode: Gleichlauffräsen.
- Bei Vibrationen oder unüblichen Geräuschen reduzieren Sie die Schnittdaten (wie oben empfohlen) entsprechend.
- Werkzeugauskragung so kurz wie möglich wählen.

● Ex Stock / ab Lager ○ On demand / auf Anfrage

4-flute flattened end mills with straight shank 4-Schneiden Eckfräser mit Zylinderschaft



PM-4E-G

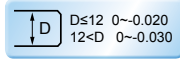
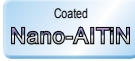
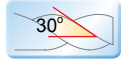
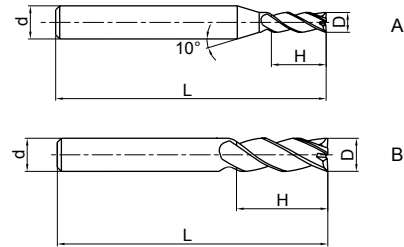

Type Typ	Dimension(mm) Abmessungen				Teeth Zähne Z	Geometry Ausführung	Grade Sorte KMG 405
	D	d	H	L			
PM-4E-D1.0S-G	1.0	4	3	50	4	A	●
PM-4E-D1.5S-G	1.5	4	4	50	4	A	●
PM-4E-D2.0S-G	2.0	4	6	50	4	A	●
PM-4E-D2.5S-G	2.5	4	8	50	4	A	●
PM-4E-D3.0S-G	3.0	4	8	50	4	A	●
PM-4E-D4.0S-G	4.0	4	11	50	4	B	●
PM-4E-D1.0-G	1.0	6	3	50	4	A	●
PM-4E-D1.5-G	1.5	6	4	50	4	A	●
PM-4E-D2.0-G	2.0	6	6	50	4	A	●
PM-4E-D2.5-G	2.5	6	8	50	4	A	●
PM-4E-D3.0-G	3.0	6	8	50	4	A	●
PM-4E-D3.5-G	3.5	6	10	50	4	A	●
PM-4E-D4.0-G	4.0	6	11	50	4	A	●
PM-4E-D4.5-G	4.5	6	11	50	4	A	●
PM-4E-D5.0-G	5.0	6	13	50	4	A	●
PM-4E-D5.5-G	5.5	6	16	50	4	A	●
PM-4E-D6.0-G	6.0	6	16	50	4	B	●
PM-4E-D7.0-G	7.0	8	20	60	4	A	●
PM-4E-D8.0-G	8.0	8	20	60	4	B	●
PM-4E-D9.0-G	9.0	10	22	75	4	A	●
PM-4E-D10.0-G	10.0	10	25	75	4	B	●
PM-4E-D11.0-G	11.0	12	26	75	4	A	●
PM-4E-D12.0-G	12.0	12	30	75	4	B	●
PM-4E-D14.0-G	14.0	14	32	75	4	B	●
PM-4E-D16.0-G	16.0	16	45	100	4	B	●
PM-4E-D18.0-G	18.0	18	45	100	4	B	●
PM-4E-D20.0-G	20.0	20	45	100	4	B	●

B

Solid Carbide end mills
Vollhartmetallschaftfräser

Material Overview · Material Übersicht

✓ = Very suitable · Sehr empfohlen
✓ = Suitable · Empfohlen

KMG405

Workpiece material Werkstückstoff											
Carbon steel Kohlenstoff Stahl	Alloy steel Legierter Stahl	Quenched and tempered steel · Vergüteter Stahl		Hardened steel · Gehärteter Stahl		Stainless steel · Rostfreier Stahl	Cast iron, Nodular cast iron Grauguss GGG	Copper alloy Kupfer Leg	Aluminum alloy Alu Leg	Titanium alloy Titan Leg	Heat resist alloy warmfeste Leg
		~40HRC	~50HRC	~55HRC	~68HRC						
✓	✓	✓	✓	✓	✓	✓	✓			✓	✓

Code key B252-B254
ISO Kennzeichen

Cutting data B272-B274
Schnittdaten

Graphics identification & application B253-B255
Graphische Werkzeug- & Anwendungsbeschr.

Order form for non-standard products B534-B535
Bestellformular für Sonderwerkzeuge

Milling · Fräsen

Solid Carbide end mills · Vollhartmetallschaftfräser

4-flute flattened end mills with straight shank and long cutting edge
4-Schneiden Eckfräser mit langer Schneide und Zylinderschaft



PM-4EL-G

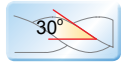
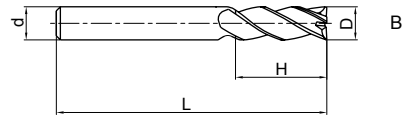
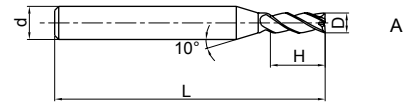
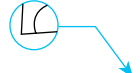

Type Typ	Dimension (mm) Abmessungen				Teeth Zähne Z	Geometry Ausführung	Grade Sorte KMG 405
	D	d	H	L			
PM-4EL-D3.0-G	3.0	6	12	75	4	A	●
PM-4EL-D4.0-G	4.0	6	15	75	4	A	●
PM-4EL-D5.0-G	5.0	6	20	75	4	A	●
PM-4EL-D6.0-G	6.0	6	20	75	4	B	●
PM-4EL-D8.0-G	8.0	8	25	100	4	B	●
PM-4EL-D10.0-G	10.0	10	30	100	4	B	●
PM-4EL-D12.0-G	12.0	12	35	100	4	B	●
PM-4EL-D14.0-G	14.0	14	40	100	4	B	●
PM-4EL-D16.0-G	16.0	16	50	150	4	B	●
PM-4EL-D20.0-G	20.0	20	55	150	4	B	●

B

Solid Carbide end mills
Vollhartmetallschaftfräser

Material Overview · Material Übersicht

✓ = Very suitable · Sehr empfohlen
✓ = Suitable · Empfohlen

KMG405

Workpiece material Werkstückstoff											
Carbon steel Kohlenstoff Stahl	Alloy steel Legierter Stahl	Quenched and tempered steel · Vergüteter Stahl		Hardened steel · Gehärteter Stahl		Stainless steel · Rostfreier Stahl	Cast iron, Nodular cast iron Grauguss GGG	Copper alloy Kupfer Leg	Aluminum alloy Alu Leg	Titanium alloy Titan Leg	Heat resist alloy warmfeste Leg
		~40HRC	~50HRC	~55HRC	~68HRC						
✓	✓	✓	✓	✓	✓	✓	✓			✓	✓

● Ex Stock / ab Lager ○ On demand / auf Anfrage

4-flute flattened end mills with straight shank and longer cutting edge
4-Schneiden Eckfräser mit Zylinderschaft und langere Schneide



PM-4EX-G

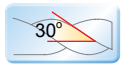
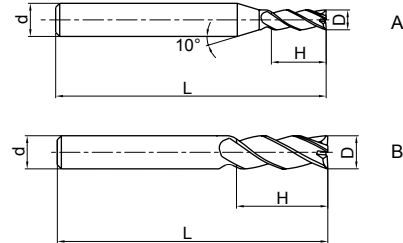
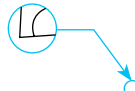

Type Typ	Dimension(mm) Abmessungen				Teeth Zähne Z	Geometry Ausführung	Grade Sorte KMG 405
	D	d	H	L			
PM-4EX-D3.0-G	3.0	6	20	75	4	A	●
PM-4EX-D4.0-G	4.0	6	25	75	4	A	●
PM-4EX-D5.0-G	5.0	6	30	75	4	A	●
PM-4EX-D6.0-G	6.0	6	30	75	4	B	●
PM-4EX-D8.0-G	8.0	8	40	100	4	B	●
PM-4EX-D10.0-G	10.0	10	50	110	4	B	●
PM-4EX-D12.0-G	12.0	12	50	110	4	B	●
PM-4EX-D16.0-G	16.0	16	70	150	4	B	●
PM-4EX-D20.0-G	20.0	20	75	150	4	B	●

B

Solid Carbide end mills
Vollhartmetallschaftfräser

Material Overview · Material Übersicht

✓ = Very suitable · Sehr empfohlen
✓ = Suitable · Empfohlen

KMG405

Workpiece material Werkstückstoff											
Carbon steel Kohlenstoff Stahl	Alloy steel Legierter Stahl	Quenched and tempered steel · Vergüteter Stahl		Hardened steel · Gehärteter Stahl		Stainless steel · Rostfreier Stahl	Cast iron, Nodular cast iron Grauguss GGG	Copper alloy Kupfer Leg	Aluminum alloy Alu Leg	Titanium alloy Titan Leg	Heat resist alloy warmfeste Leg
		~40HRC	~50HRC	~55HRC	~68HRC						
✓	✓	✓	✓	✓		✓	✓			✓	✓

Code key B252-B254
ISO Kennzeichen

Cutting data B272-B274
Schnittdaten

Graphics identification & application B253-B255
Graphische Werkzeug- & Anwendungsbeschr.

Order form for non-standard products B534-B535
Bestellformular für Sonderwerkzeuge

Milling · Fräsen

Solid Carbide end mills · Vollhartmetallschaftfräser

4-flute flattened end mills with straight shank
4-Schneiden Eckfräser mit Zylinderschaft



PM-4E

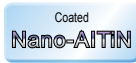
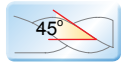
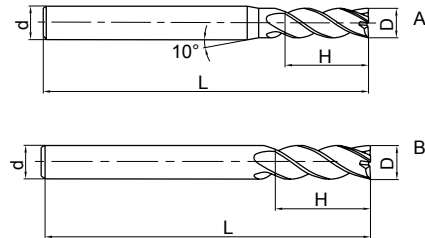

Type Typ	Dimension(mm) Abmessungen				Teeth Zähne Z	Geometry Ausführung	Grade Sorte KMG 405
	D	d	H	L			
PM-4E-D1.0S	1.0	4	3	50	4	A	●
PM-4E-D1.5S	1.5	4	4	50	4	A	●
PM-4E-D2.0S	2.0	4	6	50	4	A	●
PM-4E-D2.5S	2.5	4	8	50	4	A	●
PM-4E-D3.0S	3.0	4	8	50	4	A	●
PM-4E-D4.0S	4.0	4	11	50	4	B	●
PM-4E-D1.0	1.0	6	3	50	4	A	●
PM-4E-D1.5	1.5	6	4	50	4	A	●
PM-4E-D2.0	2.0	6	6	50	4	A	●
PM-4E-D2.5	2.5	6	8	50	4	A	●
PM-4E-D3.0	3.0	6	8	50	4	A	●
PM-4E-D3.5	3.5	6	10	50	4	A	●
PM-4E-D4.0	4.0	6	11	50	4	A	●
PM-4E-D4.5	4.5	6	11	50	4	A	●
PM-4E-D5.0	5.0	6	13	50	4	A	●
PM-4E-D5.5	5.5	6	16	50	4	A	●
PM-4E-D6.0	6.0	6	16	50	4	B	●
PM-4E-D7.0	7.0	8	20	60	4	A	●
PM-4E-D8.0	8.0	8	20	60	4	B	●
PM-4E-D9.0	9.0	10	22	75	4	A	●
PM-4E-D10.0	10.0	10	25	75	4	B	●
PM-4E-D11.0	11.0	12	26	75	4	A	●
PM-4E-D12.0	12.0	12	30	75	4	B	●
PM-4E-D14.0	14.0	14	32	75	4	B	●
PM-4E-D16.0	16.0	16	45	100	4	B	●
PM-4E-D18.0	18.0	18	45	100	4	B	●
PM-4E-D20.0	20.0	20	45	100	4	B	●

B

Solid Carbide end mills
Vollhartmetallschaftfräser

Material Overview · Material Übersicht

✓ = Very suitable · Sehr empfohlen
✓ = Suitable · Empfohlen

KMG405

		Workpiece material Werkstückstoff									
Carbon steel Kohlenstoff Stahl	Alloy steel Legierter Stahl	Quenched and tempered steel · Vergüteter Stahl		Hardened steel · Gehärteter Stahl		Stainless steel · Rostfreier Stahl	Cast iron, Nodular cast iron Grauguss GGG	Copper alloy Kupfer Leg	Aluminum alloy Alu Leg	Titanium alloy Titan Leg	Heat resist alloy warmfeste Leg
		~40HRC	~50HRC	~55HRC	~68HRC						
✓	✓	✓	✓	✓	✓	✓	✓			✓	✓

● Ex Stock / ab Lager ○ On demand / auf Anfrage

4-flute flattened end mills with straight shank and long cutting edge
4-Schneiden Eckfräser mit langer Schneide und Zylinderschaft



PM-4EL

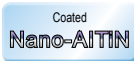
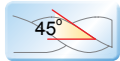
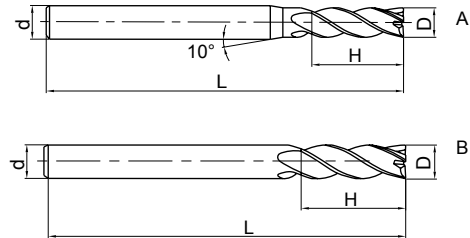

Type Typ	Dimension (mm) Abmessungen				Teeth Zähne Z	Geometry Ausführung	Grade Sorte KMG 405
	D	d	H	L			
PM-4EL-D3.0	3.0	6	12	75	4	A	●
PM-4EL-D4.0	4.0	6	15	75	4	A	●
PM-4EL-D5.0	5.0	6	20	75	4	A	●
PM-4EL-D6.0	6.0	6	20	75	4	B	●
PM-4EL-D8.0	8.0	8	25	100	4	B	●
PM-4EL-D10.0	10.0	10	30	100	4	B	●
PM-4EL-D12.0	12.0	12	35	100	4	B	●
PM-4EL-D14.0	14.0	14	40	100	4	B	●
PM-4EL-D16.0	16.0	16	50	150	4	B	●
PM-4EL-D20.0	20.0	20	55	150	4	B	●

B

Solid Carbide end mills
Vollhartmetallschaftfräser

Material Overview · Material Übersicht

✓ = Very suitable · Sehr empfohlen
✓ = Suitable · Empfohlen

KMG405

Workpiece material Werkstückstoff											
Carbon steel Kohlenstoff Stahl	Alloy steel Legierter Stahl	Quenched and tempered steel · Vergüteter Stahl		Hardened steel · Gehärteter Stahl		Stainless steel · Rostfreier Stahl	Cast iron, Nodular cast iron Grauguss GGG	Copper alloy Kupfer Leg	Aluminum alloy Alu Leg	Titanium alloy Titan Leg	Heat resist alloy warmfeste Leg
		~40HRC	~50HRC	~55HRC	~68HRC						
✓	✓	✓	✓	✓		✓	✓			✓	✓

Code key B252,B254
ISO Kennzeichen

Cutting data B272-B274
Schnittdaten

Graphics identification & application B253-B255
Graphische Werkzeug- & Anwendungsbeschr.

Order form for non-standard products B534-B535
Bestellformular für Sonderwerkzeuge

Milling - Fräsen

Solid Carbide end mills - Vollhartmetallschaftfräser

Recommended cutting data · Empfohlene Schnittdaten

PM-4E-G | PM-4EL-G

Workpiece material Werkstückmaterial	Cast iron, Carbon steel, Alloy steel Kohlenstoffstahl Leg. Stahl ~30HRC		Stainless steel Rostfreier Stahl		Pre-hardened steel, Quenched and tempered steel Vergüteter Stahl ~40HRC		Pre-hardened steel, Quenched and tempered steel Vergüteter Stahl ~50HRC		Hardened steel Gehärteter Stahl ~55HRC	
	Diameter Ø Durchmesse (mm)	Rotating Drehzahl (min ⁻¹)	Feed Vorschub (mm/min)	Rotating Drehzahl (min ⁻¹)	Feed Vorschub (mm/min)	Rotating Drehzahl (min ⁻¹)	Feed Vorschub (mm/min)	Rotating Drehzahl (min ⁻¹)	Feed Vorschub (mm/min)	Rotating Drehzahl (min ⁻¹)
1	20000	270	20000	95	20000	215	20000	135	20000	120
2	15000	435	11150	110	15000	380	13000	200	11140	175
3	14000	735	7500	135	10600	565	8500	370	7430	325
4	10800	755	5500	140	8000	575	6500	380	5570	335
5	8200	795	4500	140	6400	605	5000	400	4460	350
6	7000	810	3700	145	5300	620	4200	405	3710	350
8	5200	800	2800	145	4000	615	3200	415	2785	365
10	4200	795	2200	145	3200	605	2500	390	2230	340
12	3500	795	1850	145	2650	605	2100	390	1855	340
14	3000	735	1600	140	2300	565	1800	370	1590	325
16	2600	735	1400	135	2000	565	1600	370	1390	325
18	2300	720	1250	115	1800	555	1400	365	1240	315
20	2050	720	1100	115	1600	555	1250	365	1115	315

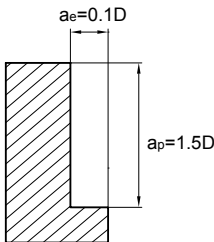
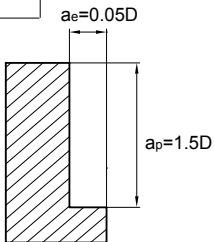
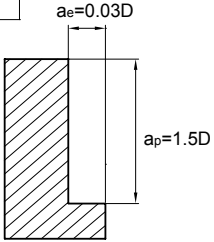
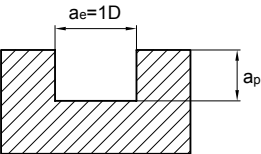
Max. cutting depth max. Schnitttiefe						
	Milling slot Ø	Nutenfräsen Ap	Milling slot Ø	Nutenfräsen Ap	Milling slot Ø	Nutenfräsen Ap
	Ø1≤D<Ø3	0.15D	Ø1≤D<Ø3	0.1D	Ø3≤D	0.2D
	Ø3≤D<Ø6	0.3D				
	Ø6≤D<Ø20	0.5D				

- The above table shows the standard value of side milling. When slot milling, of rotating speed 50%~70% and feed rate like mentioned above 40%~60%.
- Please select high precise machine and tool holder.
- Please use air blow or cutting liquid with high mist retardant property.
- Down milling is recommended in side milling.
- Vibration and unusual noise may be generated if the machine rigidity and workpiece fixture stability is low, please reduce the rotating speed and feed rate like mentioned above.
- Make overhang as short as possible if no interference.

- Die obige Tabelle zeigt Standard Werte für das Eckfräsen. Bei Nutenfräsen, Schnittgeschwindigkeit auf 50-70% und den Vorschub auf 40-60% reduzieren.
- Bitte präzise Maschinen und Werkzeughalter verwenden.
- Bitte Luftkühlung oder Schneidflüssigkeit benutzen.
- Empfohlene Fräsmethode: Gleichlaufverfahren.
- Bei Vibrationen oder ungewöhnlichen Geräuschen reduzieren Sie die Schnittdaten (wie oben empfohlen) entsprechend.
- Werkzeugauskrägung so kurz wie möglich wählen.

Recommended cutting data · Empfohlene Schnittdaten

PM-4EX-G

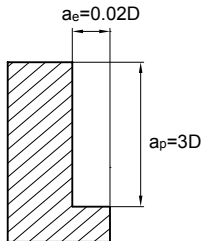
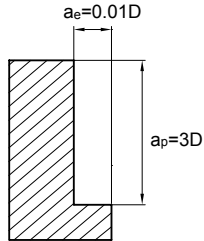
Workpiece material Werkstückmaterial	Cast iron, Carbon steel, Alloy steel Kohlenstoffstahl Leg. Stahl ~30HRC		Stainless steel Rostfreier Stahl		Pre-hardened steel, Quenched and tempered steel Vergüteter Stahl ~40HRC		Pre-hardened steel, Quenched and tempered steel Vergüteter Stahl ~50HRC		Hardened steel Gehärteter Stahl ~55HRC		
	Diameter Ø Durchmesser (mm)	Rotating Drehzahl (min ⁻¹)	Feed Vorschub (mm/min)	Rotating Drehzahl (min ⁻¹)	Feed Vorschub (mm/min)	Rotating Drehzahl (min ⁻¹)	Feed Vorschub (mm/min)	Rotating Drehzahl (min ⁻¹)	Feed Vorschub (mm/min)	Rotating Drehzahl (min ⁻¹)	Feed Vorschub (mm/min)
6	5800	570	2650	85	4250	410	3600	345	3180	305	
8	4400	570	2000	85	3180	410	2700	350	2390	310	
10	3500	555	1600	85	2550	400	2150	340	1910	300	
12	2900	555	1350	85	2120	400	1800	340	1590	300	
16	2200	520	1000	80	1590	380	1350	315	1195	280	
20	1750	510	800	75	1270	375	1050	310	955	280	
Max. cutting depth max. Schnitttiefe											

1. Please select high precise machine and tool holder.
2. Please use air blow or MQL (minimum oil mist cooling).
3. Down milling is recommended in side milling.
4. Vibration and unusual noise may be generated if the machine rigidity and workpiece fixture stability is low, please reduce the rotating speed and feed rate like mentioned above.
5. Make overhang as short as possible if no interference.

1. Bitte präzise Maschinen und Werkzeughalter verwenden.
2. Als Kühlmittel bitte Luft oder MQL (Minimalmengen) verwenden.
3. Empfohlene Fräsmethode: Gleichlaufräsen.
4. Bei Vibrationen oder unüblichen Geräuschen reduzieren Sie die Schnittdaten (wie oben empfohlen) entsprechend.
5. Werkzeugauskrantung so kurz wie möglich wählen.

Milling · Fräsen

Solid Carbide end mills · Vollhartmetallschaftfräser

Recommended cutting data · Empfohlene Schnittdaten

PM-4E | PM-4EL

Workpiece material Werkstückmaterial	Cast iron, Carbon steel, Alloy steel Kohlenstoffstahl Leg. Stahl ~30HRC		Stainless steel Rostfreier Stahl		Pre-hardened steel, Quenched and tempered steel Vergüteter Stahl ~40HRC		Pre-hardened steel, Quenched and tempered steel Vergüteter Stahl ~50HRC		Hardened steel Gehärteter Stahl ~55HRC	
	Diameter Ø Durchmesser (mm)	Rotating Drehzahl (min ⁻¹)	Feed Vorschub (mm/min)	Rotating Drehzahl (min ⁻¹)	Feed Vorschub (mm/min)	Rotating Drehzahl (min ⁻¹)	Feed Vorschub (mm/min)	Rotating Drehzahl (min ⁻¹)	Feed Vorschub (mm/min)	Rotating Drehzahl (min ⁻¹)
1	20000	300	20000	108	20000	240	20000	180	20000	135
2	15000	480	11150	120	15000	420	13000	270	11140	195
3	14000	815	7500	145	10600	630	8500	495	7430	360
4	10800	840	5500	150	8000	645	6500	505	5570	370
5	8200	875	4500	150	6400	675	5000	530	4460	390
6	7000	900	3700	165	5300	690	4200	540	3710	390
8	5200	890	2800	165	4000	680	3200	555	2785	405
10	4200	875	2200	165	3200	675	2500	525	2230	375
12	3500	875	1850	165	2650	675	2100	525	1855	375
14	3000	815	1600	150	2300	630	1800	495	1590	360
16	2600	815	1400	145	2000	630	1600	495	1390	360
18	2300	805	1250	125	1800	620	1400	485	1240	350
20	2050	805	1100	125	1600	620	1250	485	1115	350

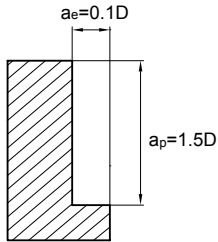
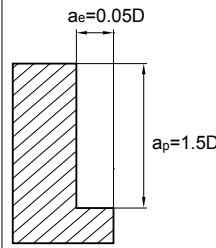
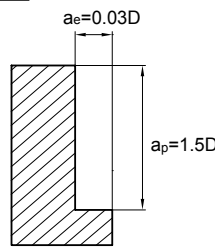
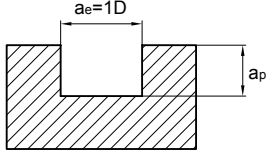
Max. cutting depth max. Schnitttiefe																			
	 <table border="1" data-bbox="654 1377 901 1534"> <thead> <tr> <th>Milling slot</th> <th>Nutenfräsen</th> </tr> <tr> <th>Ø</th> <th>Ap</th> </tr> </thead> <tbody> <tr> <td>Ø1 ≤ D < Ø3</td> <td>0.15D</td> </tr> <tr> <td>Ø3 ≤ D < Ø6</td> <td>0.3D</td> </tr> <tr> <td>Ø6 ≤ D < Ø20</td> <td>0.5D</td> </tr> </tbody> </table>	Milling slot	Nutenfräsen	Ø	Ap	Ø1 ≤ D < Ø3	0.15D	Ø3 ≤ D < Ø6	0.3D	Ø6 ≤ D < Ø20	0.5D	<table border="1" data-bbox="1029 1400 1276 1523"> <thead> <tr> <th>Milling slot</th> <th>Nutenfräsen</th> </tr> <tr> <th>Ø</th> <th>Ap</th> </tr> </thead> <tbody> <tr> <td>Ø1 ≤ D < Ø3</td> <td>0.1D</td> </tr> <tr> <td>Ø3 ≤ D</td> <td>0.2D</td> </tr> </tbody> </table>	Milling slot	Nutenfräsen	Ø	Ap	Ø1 ≤ D < Ø3	0.1D	Ø3 ≤ D
Milling slot	Nutenfräsen																		
Ø	Ap																		
Ø1 ≤ D < Ø3	0.15D																		
Ø3 ≤ D < Ø6	0.3D																		
Ø6 ≤ D < Ø20	0.5D																		
Milling slot	Nutenfräsen																		
Ø	Ap																		
Ø1 ≤ D < Ø3	0.1D																		
Ø3 ≤ D	0.2D																		

- The above table shows the standard value of side milling. When slot milling, of rotating speed 50%~70% and feed rate like mentioned above 40%~60%.
- Please select high precise machine and tool holder.
- Please use air blow or cutting liquid with high mist retardant property.
- Down milling is recommended in side milling.
- Vibration and unusual noise may be generated if the machine rigidity and workpiece fixture stability is low, please reduce the rotating speed and feed rate like mentioned above.
- Make overhang as short as possible if no interference.

- Die obige Tabelle zeigt Standard Werte für das Eckfräsen. Bei Nutenfräsen, Schnittgeschwindigkeit auf 50-70% und den Vorschub auf 40-60% reduzieren.
- Bitte präzise Maschinen und Werkzeughalter verwenden.
- Bitte Luftkühlung oder Schneidflüssigkeit benutzen.
- Empfohlene Fräsmethode: Gleichlaufräsen.
- Bei Vibrationen oder unüblichen Geräuschen reduzieren Sie die Schnittdaten (wie oben empfohlen) entsprechend.
- Werkzeugauskrantung so kurz wie möglich wählen.

● Ex Stock / ab Lager ○ On demand / auf Anfrage

6-flute flattened end mills with straight shank 6-Schneiden Eckfräser mit Zylinderschaft



PM-6E

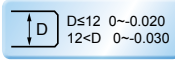
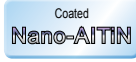
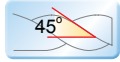
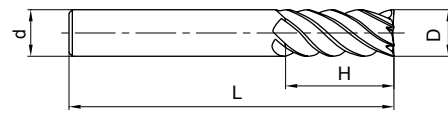

Type Typ	Dimension(mm) Abmessungen				Teeth Zähne Z	Grade Sorte KMG 405
	D	d	H	L		
PM-6E-D6.0	6.0	6	18	60	6	●
PM-6E-D8.0	8.0	8	20	60	6	●
PM-6E-D10.0	10.0	10	30	75	6	●
PM-6E-D12.0	12.0	12	32	75	6	●
PM-6E-D16.0	16.0	16	40	100	6	●
PM-6E-D20.0	20.0	20	45	100	6	●

B

Solid Carbide end mills
Vollhartmetallschaftfräser

Material Overview · Material Übersicht

✓ = Very suitable · Sehr empfohlen
✓ = Suitable · Empfohlen

KMG405

Workpiece material Werkstückstoff											
Carbon steel Kohlenstoff Stahl	Alloy steel Legierter Stahl	Quenched and tempered steel · Vergüteter Stahl		Hardened steel · Gehärteter Stahl		Stainless steel · Rostfreier Stahl	Cast iron, Nodular cast iron Grauguss GGG	Copper alloy Kupfer Leg	Aluminum alloy Alu Leg	Titanium alloy Titan Leg	Heat resist alloy warmfeste Leg
		~40HRC	~50HRC	~55HRC	~68HRC						
✓	✓	✓	✓	✓		✓	✓			✓	✓

Code key **B252-B254**
ISO Kennzeichen

Cutting data **B277-B278**
Schnittdaten

Graphics identification & application **B253-B255**
Graphische Werkzeug- & Anwendungsbeschr.

Order form for non-standard products **B534-B535**
Bestellformular für Sonderwerkzeuge

B275

Milling · Fräsen

Solid Carbide end mills · Vollhartmetallschaftfräser

6-flute flattened end mills with straight shank and long cutting edge
6-Schneiden Eckfräser mit langer Schneide und Zylinderschaft

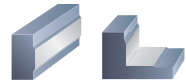

PM-6EL

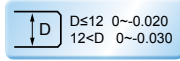
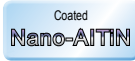
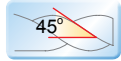
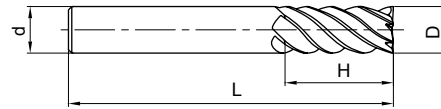

Type Typ	Dimension(mm) Abmessungen				Teeth Zähne Z	Grade Sorte KMG 405
	D	d	H	L		
PM-6EL-D6.0	6.0	6	24	75	6	●
PM-6EL-D8.0	8.0	8	32	75	6	●
PM-6EL-D10.0	10.0	10	40	100	6	●
PM-6EL-D12.0	12.0	12	45	100	6	●
PM-6EL-D16.0	16.0	16	64	150	6	●
PM-6EL-D20.0	20.0	20	75	150	6	●

B

Solid Carbide end mills
Vollhartmetallschaftfräser

Material Overview · Material Übersicht

✓ = Very suitable · Sehr empfohlen
✓ = Suitable · Empfohlen

KMG405

Workpiece material Werkstückstoff											
Carbon steel Kohlenstoff Stahl	Alloy steel Legierter Stahl	Quenched and tempered steel · Vergüteter Stahl		Hardened steel · Gehärteter Stahl		Stainless steel · Rostfreier Stahl	Cast iron, Nodular cast iron Grauguss GGG	Copper alloy Kupfer Leg	Aluminum alloy Alu Leg	Titanium alloy Titan Leg	Heat resist alloy warmfeste Leg
		~40HRC	~50HRC	~55HRC	~68HRC						
✓	✓	✓	✓	✓		✓	✓			✓	✓

● Ex Stock / ab Lager ○ On demand / auf Anfrage

Recommended cutting data · Empfohlene Schnittdaten

PM-6E

Workpiece material Werkstückmaterial	Cast iron, Carbon steel, Alloy steel Kohlenstoffstahl Leg. Stahl ~30HRC		Stainless steel Rostfreier Stahl		Pre-hardened steel, Quenched and tempered steel Vergüteter Stahl ~40HRC		Pre-hardened steel, Quenched and tempered steel Vergüteter Stahl ~50HRC		Hardened steel Gehärteter Stahl ~55HRC	
	Diameter Ø Durchmesser (mm)	Rotating Drehzahl (min ⁻¹)	Feed Vorschub (mm/min)	Rotating Drehzahl (min ⁻¹)	Feed Vorschub (mm/min)	Rotating Drehzahl (min ⁻¹)	Feed Vorschub (mm/min)	Rotating Drehzahl (min ⁻¹)	Feed Vorschub (mm/min)	Rotating Drehzahl (min ⁻¹)
6	7000	1070	3700	195	5300	815	4200	650	3710	470
8	5200	1070	2800	195	4000	815	3200	660	2785	485
10	4200	1035	2200	195	3200	800	2500	630	2230	450
12	3500	1035	1850	195	2650	800	2100	630	1855	450
16	2600	975	1400	180	2000	750	1600	590	1390	435
20	2050	960	1100	150	1600	740	1250	580	1115	420
Max. cutting depth max Schnitttiefe										

1. Please select high precise machine and tool holder.
2. Please use air blow or MQL (minimum oil mist cooling).
3. Down milling is recommended in side milling.
4. Vibration and unusual noise may be generated if the machine rigidity and workpiece fixture stability is low, please reduce the rotating speed and feed rate like mentioned above.
5. Make overhang as short as possible if no interference.

1. Bitte präzise Maschinen und Werkzeughalter verwenden.
2. Als Kühlmittel bitte Luft oder MQL (Minimalmengen) verwenden.
3. Empfohlene Fräsmethode: Gleichlaufräsen.
4. Bei Vibrationen oder ungewöhnlichen Geräuschen reduzieren Sie die Schnittdaten (wie oben empfohlen) entsprechend.
5. Werkzeugauskrantung so kurz wie möglich wählen.

Milling · Fräsen

Solid Carbide end mills · Vollhartmetallschaftfräser

Recommended cutting data · Empfohlene Schnittdaten

PM-6EL

Workpiece material Werkstückmaterial	Cast iron, Carbon steel, Alloy steel Kohlenstoffstahl Leg. Stahl ~30HRC		Stainless steel Rostfreier Stahl		Pre-hardened steel, Quenched and tempered steel Vergüteter Stahl ~40HRC		Pre-hardened steel, Quenched and tempered steel Vergüteter Stahl ~50HRC		Hardened steel Gehärteter Stahl ~55HRC			
	Diameter Ø Durchmesse (mm)	Rotating Drehzahl (min ⁻¹)	Feed Vorschub (mm/min)	Rotating Drehzahl (min ⁻¹)	Feed Vorschub (mm/min)	Rotating Drehzahl (min ⁻¹)	Feed Vorschub (mm/min)	Rotating Drehzahl (min ⁻¹)	Feed Vorschub (mm/min)	Rotating Drehzahl (min ⁻¹)	Feed Vorschub (mm/min)	
6	5800	900	2650	140	4250	655	3600	555	3180	490		
8	4400	900	2000	140	3180	655	2700	560	2390	495		
10	3500	875	1600	140	2550	635	2150	530	1910	470		
12	2900	875	1350	140	2120	635	1800	530	1590	470		
16	2200	825	1000	125	1590	600	1350	500	1195	445		
20	1750	810	800	110	1270	590	1050	495	955	440		
Max. cutting depth max Schnitttiefe												

1. Please select high precise machine and tool holder.
2. Please use air blow or MQL (minimum oil mist cooling).
3. Down milling is recommended in side milling.
4. Vibration and unusual noise may be generated if the machine rigidity and workpiece fixture stability is low, please reduce the rotating speed and feed rate like mentioned above.
5. Make overhang as short as possible if no interference.

1. Bitte präzise Maschinen und Werkzeughalter verwenden.
2. Als Kühlmittel bitte Luft oder MQL (Minimalmengen) verwenden.
3. Empfohlene Fräsmethode: Gleichlaufräsen.
4. Bei Vibrationen oder unüblichen Geräuschen reduzieren Sie die Schnittdaten (wie oben empfohlen) entsprechend.
5. Werkzeugauskragung so kurz wie möglich wählen.

● Ex Stock / ab Lager ○ On demand / auf Anfrage

2-flute ball nose end mills with straight shank 2-Schneiden Kugelkopffräser mit Zylinderschaft



PM-2B

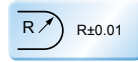
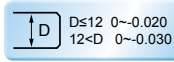
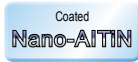
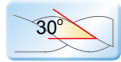
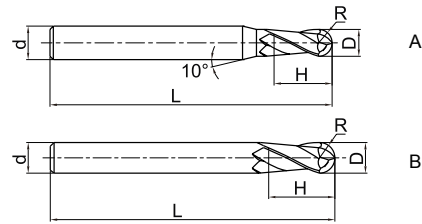

Type Typ	Dimension(mm) Abmessungen					Teeth Zähne Z	Geometry Ausführung	Grade Sorte KMG 405
	D	R	d	H	L			
PM-2B-R0.5S	1.0	0.5	4	2	50	2	A	●
PM-2B-R0.75S	1.5	0.75	4	3	50	2	A	●
PM-2B-R1.0S	2.0	1.0	4	4	50	2	A	●
PM-2B-R1.25S	2.5	1.25	4	5	50	2	A	●
PM-2B-R1.5S	3.0	1.5	4	6	50	2	A	●
PM-2B-R2.0S	4.0	2.0	4	8	50	2	B	●
PM-2B-R0.5	1.0	0.5	6	2	50	2	A	●
PM-2B-R0.75	1.5	0.75	6	3	50	2	A	●
PM-2B-R1.0	2.0	1.0	6	4	50	2	A	●
PM-2B-R1.25	2.5	1.25	6	5	50	2	A	●
PM-2B-R1.5	3.0	1.5	6	6	50	2	A	●
PM-2B-R1.75	3.5	1.75	6	8	50	2	A	●
PM-2B-R2.0	4.0	2.0	6	8	50	2	A	●
PM-2B-R2.5	5.0	2.5	6	10	50	2	A	●
PM-2B-R2.75	5.5	2.75	6	12	50	2	A	●
PM-2B-R3.0	6.0	3.0	6	12	50	2	B	●
PM-2B-R3.5	7.0	3.5	8	14	60	2	A	●
PM-2B-R4.0	8.0	4.0	8	16	60	2	B	●
PM-2B-R4.5	9.0	4.5	10	18	75	2	A	●
PM-2B-R5.0	10.0	5.0	10	20	75	2	B	●
PM-2B-R6.0	12.0	6.0	12	24	75	2	B	●
PM-2B-R7.0	14.0	7.0	14	28	75	2	B	●
PM-2B-R8.0	16.0	8.0	16	32	100	2	B	●
PM-2B-R10.0	20.0	10.0	20	40	100	2	B	●

B

Solid Carbide end mills
Vollhartmetallschaftfräser

Material Overview · Material Übersicht

✓ = Very suitable · Sehr empfohlen
✓ = Suitable · Empfohlen

KMG405

Workpiece material Werkstückstoff											
Carbon steel Kohlenstoff Stahl	Alloy steel Legierter Stahl	Quenched and tempered steel · Vergüteter Stahl		Hardened steel · Gehärteter Stahl		Stainless steel · Rostfreier Stahl	Cast iron, Nodular cast iron Grauguss GGG	Copper alloy Kupfer Leg	Aluminum alloy Alu Leg	Titanium alloy Titan Leg	Heat resist alloy warmfeste Leg
		~40HRC	~50HRC	~55HRC	~68HRC						
✓	✓	✓	✓	✓	✓	✓	✓			✓	✓

Code key **B252-B254**
ISO Kennzeichen

Cutting data **B286-B289**
Schnittdaten

Graphics identification & application **B253-B255**
Graphische Werkzeug- & Anwendungsbeschr.

Order form for non-standard products **B534-B535**
Bestellformular für Sonderwerkzeuge

Milling · Fräsen

Solid Carbide end mills · Vollhartmetallschaftfräser

2-flute ball nose end mills with straight shank and long cutting edge
2-Schneiden Kugelpkopfräser mit langer Schneide und Zylinderschaft



PM-2BL

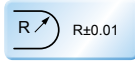
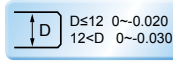
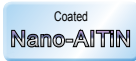
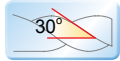
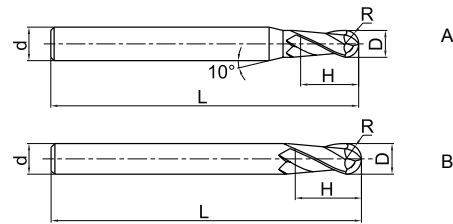

Type Typ	Dimension(mm) Abmessungen					Teeth Zähne Z	Geometry Ausführung	Grade Sorte KMG 405
	D	R	d	H	L			
PM-2BL-R1.0	2.0	1.0	6	4	75	2	A	●
PM-2BL-R1.25	2.5	1.25	6	5	75	2	A	●
PM-2BL-R1.5	3.0	1.5	6	6	75	2	A	●
PM-2BL-R1.75	3.5	1.75	6	8	75	2	A	●
PM-2BL-R2.0	4.0	2.0	6	8	75	2	A	●
PM-2BL-R2.5	5.0	2.5	6	10	75	2	A	●
PM-2BL-R2.75	5.5	2.75	6	12	75	2	A	●
PM-2BL-R3.0	6.0	3.0	6	12	75	2	B	●
PM-2BL-R3.5	7.0	3.5	8	14	75	2	A	●
PM-2BL-R4.0	8.0	4.0	8	16	100	2	B	●
PM-2BL-R4.5	9.0	4.5	10	18	100	2	A	●
PM-2BL-R5.0	10.0	5.0	10	20	100	2	B	●
PM-2BL-R6.0	12.0	6.0	12	24	100	2	B	●
PM-2BL-R7.0	14.0	7.0	14	28	100	2	B	●
PM-2BL-R8.0	16.0	8.0	16	32	150	2	B	●
PM-2BL-R10.0	20.0	10.0	20	40	150	2	B	●

B

Solid Carbide end mills
Vollhartmetallschaftfräser

Material Overview · Material Übersicht

✓ = Very suitable · Sehr empfohlen
✓ = Suitable · Empfohlen

KMG405

		Workpiece material Werkstückstoff									
Carbon steel Kohlenstoff Stahl	Alloy steel Legierter Stahl	Quenched and tempered steel · Vergüteter Stahl		Hardened steel · Gehärteter Stahl		Stainless steel · Rostfreier Stahl	Cast iron, Nodular cast iron Grauguss GGG	Copper alloy Kupfer Leg	Aluminum alloy Alu Leg	Titanium alloy Titan Leg	Heat resist alloy warmfeste Leg
		~40HRC	~50HRC	~55HRC	~68HRC						
✓	✓	✓	✓	✓		✓	✓			✓	✓

● Ex Stock / ab Lager ○ On demand / auf Anfrage

2-flute straight shank ball nose end mills with short cutting edge and long neck
2-Schneiden Kugelkopffräser mit kurzer Schneide und Zylinderschaft



PM-2BFP

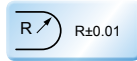
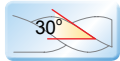
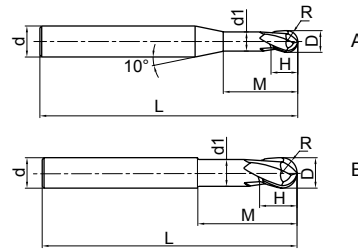

Type Typ	Dimension(mm) Abmessungen							Teeth Zähne Z	Geometry Ausführung	Grade Sorte KMG 405
	D	R	H	d ₁	M	d	L			
PM-2BFP-R0.5	1.0	0.5	1	0.95	2.5	6	75	2	A	●
PM-2BFP-R0.75	1.5	0.75	1.5	1.45	3	6	75	2	A	●
PM-2BFP-R1.0	2.0	1.0	2	1.95	4	6	75	2	A	●
PM-2BFP-R1.5	3.0	1.5	3	2.85	6	6	75	2	A	●
PM-2BFP-R2.0	4.0	2.0	4	3.85	8	6	75	2	A	●
PM-2BFP-R2.5	5.0	2.5	5	4.85	10	6	75	2	A	●
PM-2BFP-R3.0	6.0	3.0	6	5.8	12	6	75	2	B	●
PM-2BFP-R4.0	8.0	4.0	8	7.8	16	8	100	2	B	●
PM-2BFP-R5.0	10.0	5.0	10	9.6	20	10	100	2	B	●
PM-2BFP-R6.0	12.0	6.0	12	11.5	24	12	100	2	B	●
PM-2BFP-R8.0	16.0	8.0	16	15.5	32	16	150	2	B	●
PM-2BFP-R10.0	20.0	10.0	20	19.5	40	20	150	2	B	●

B

Solid Carbide end mills
Vollhartmetallschaftfräser

Material Overview · Material Übersicht

✓ = Very suitable · Sehr empfohlen
✓ = Suitable · Empfohlen

KMG405

Workpiece material Werkstückstoff											
Carbon steel Kohlenstoff Stahl	Alloy steel Legierter Stahl	Quenched and tempered steel · Vergüteter Stahl		Hardened steel · Gehärteter Stahl		Stainless steel · Rostfreier Stahl	Cast iron, Nodular cast iron Grauguss GGG	Copper alloy Kupfer Leg	Aluminum alloy Alu Leg	Titanium alloy Titan Leg	Heat resist alloy warmfeste Leg
		~40HRC	~50HRC	~55HRC	~68HRC						
✓	✓	✓	✓	✓	✓	✓	✓			✓	✓

Code key **B252-B254**
ISO Kennzeichen

Cutting data **B286-B289**
Schnittdaten

Graphics identification & application **B253-B255**
Graphische Werkzeug- & Anwendungsbeschr.

Order form for non-standard products **B534-B535**
Bestellformular für Sonderwerkzeuge

Milling · Fräsen

Solid Carbide end mills · Vollhartmetallschaftfräser

2-flute conical neck ball nose end mills 2-Schneiden Mikro Kugelkopffräser mit konischem Hals



PM-2BC

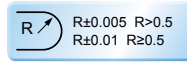
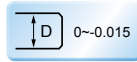
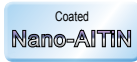
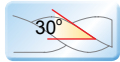
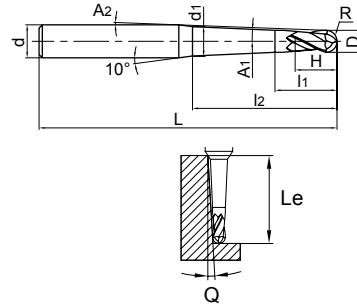

B

Solid Carbide end mills
Vollhartmetallschaftfräser

Type Typ	Dimension(mm) Abmessungen										Teeth Zähne Z	Le(Q ^Λ = Le)				Grade Sorte KMG 405
	D	R	A1	H	l2	l1	A2	d1	L	d		Q=0.5°	Q=1°	Q=2°	Q=3°	
PM-2BC05-R0.25-M03	0.5	0.25	0.5°	0.5	3	1.5	7.8°	0.49	50	4	2	3.3	3.5	3.9	4.4	○
PM-2BC05-R0.25-M05					5		6.8°	0.53			2	5.3	5.6	6.2	7.1	○
PM-2BC10-R0.25-M03			1.0°		3		7.8°	0.52			2	-	3.4	3.8	4.3	○
PM-2BC10-R0.25-M05					5		6.9°	0.59			2	-	5.4	6.0	6.8	○
PM-2BC15-R0.25-M03			1.5°		3		7.9°	0.54			2	-	-	3.7	4.1	○
PM-2BC15-R0.25-M05					5		7.0°	0.65			2	-	-	5.8	6.6	●
PM-2BC05-R0.30-M05	0.6	0.30	0.5°	0.6	5	1.6	6.8°	0.62	50	4	2	5.3	5.6	6.2	7.1	○
PM-2BC05-R0.30-M08					8		5.7°	0.68			2	8.3	8.7	9.8	11.1	○
PM-2BC10-R0.30-M05			1.0°		5		6.8°	0.68			2	-	5.4	6.0	6.8	○
PM-2BC10-R0.30-M08					8		5.8°	0.79			2	-	8.4	9.4	10.7	○
PM-2BC10-R0.30-M10			1.5°		10		5.2°	0.86			2	-	10.4	11.6	13.2	○
PM-2BC10-R0.30-M12					12		4.8°	0.93			2	-	12.4	13.9	15.8	○
PM-2BC10-R0.30-M15	0.8	0.40	0.5°	0.8	15	1.8	4.2°	1.03	50	4	2	-	15.4	17.2	19.6	○
PM-2BC15-R0.30-M05					5		6.9°	0.74			2	-	-	5.8	6.6	○
PM-2BC15-R0.30-M08			1.0°		8		5.9°	0.90			2	-	-	9.0	10.2	○
PM-2BC05-R0.40-M08					1.5°		8	5.5°			0.87	2	8.3	8.7	9.8	11.1
PM-2BC05-R0.40-M12			12				4.5°	0.94			60	2	12.3	13.0	14.5	16.5
PM-2BC10-R0.40-M08			1.0°		8		5.6°	0.98			50	2	-	8.4	9.4	10.7
PM-2BC10-R0.40-M12	1.5°	12		4.6°	1.12	60	2	-	12.4	13.9	15.8	○				
PM-2BC15-R0.40-M08		1.0°	8	5.8°	1.09	50	2	-	-	9.0	10.2	○				
PM-2BC15-R0.40-M12	1.5°		12	4.8°	1.30	60	2	-	-	13.2	15.0	○				

Material Overview · Material Übersicht

✓ = Very suitable · Sehr empfohlen
 ✓ = Suitable · Empfohlen

KMG405	Workpiece material Werkstückstoff											
	Carbon steel Kohlenstoff Stahl	Alloy steel Legierter Stahl	Quenched and tempered steel · Vergüteter Stahl		Hardened steel · Gehärteter Stahl		Stainless steel · Rostfreier Stahl	Cast iron, Nodular cast iron Grauguss GGG	Copper alloy Kupfer Leg	Aluminum alloy Alu Leg	Titanium alloy Titan Leg	Heat resist alloy warmfeste Leg
			~40HRC	~50HRC	~55HRC	~68HRC						
✓	✓	✓	✓	✓	✓	✓	✓	✓	✓	✓	✓	✓

● Ex Stock / ab Lager ○ On demand / auf Anfrage

2-flute conical neck ball nose end mills 2-Schneiden Mikro Kugelkopffräser mit konischem Hals



PM-2BC

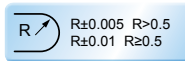
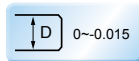
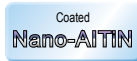
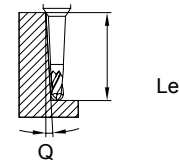
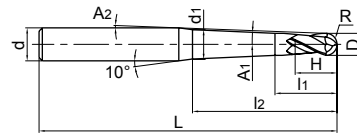

Type Typ	Dimension(mm) Abmessungen											Teeth Zähne Z	Q $\hat{=}$ Le				Grade Sorte KMG 405				
	D	R	A ₁	H	l ₂	l ₁	A ₂	d ₁	L	d	0.5°		1°	2°	3°						
PM-2BC05-R0.50-M10	1.0	0.50	0.5°	1.0	10	2.5	6.1°	1.08	60	6	2	10.4	10.9	12.2	13.9	●					
PM-2BC05-R0.50-M15					15		5.1°	1.16	60		2	15.4	16.2	18.2	20.7	●					
PM-2BC05-R0.50-M20					20		4.4°	1.25	70		2	20.4	21.5	24.1	27.4	●					
PM-2BC05-R0.50-M25					25		3.8°	1.34	70		2	25.4	26.8	30.0	34.2	○					
PM-2BC05-R0.50-M30					30		3.4°	1.42	70		2	30.4	32.0	35.9	41.0	●					
PM-2BC10-R0.50-M10					10		6.2°	1.21	60		2	-	10.5	11.8	13.4	●					
PM-2BC10-R0.50-M15					15		5.2°	1.38	60		2	-	15.5	17.4	19.8	○					
PM-2BC10-R0.50-M20					20		4.5°	1.56	70		2	-	20.5	23.0	26.2	●					
PM-2BC10-R0.50-M25					25		3.9°	1.73	70		2	-	25.5	28.6	32.6	○					
PM-2BC10-R0.50-M30					30		3.5°	1.91	70		2	-	30.5	34.2	39.0	○					
PM-2BC10-R0.50-M35			35		3.2°		2.08	80	2		-	35.5	39.8	45.4	●						
PM-2BC15-R0.50-M10			10		6.3°		1.34	60	2		-	-	11.3	12.8	●						
PM-2BC15-R0.50-M15			15		5.3°		1.60	60	2		-	-	16.6	18.9	●						
PM-2BC15-R0.50-M20			20		4.6°		1.86	70	2		-	-	21.9	24.9	●						
PM-2BC20-R0.50-M15			15		5.4°		1.82	60	2		-	-	15.8	18.0	○						
PM-2BC20-R0.50-M20			20		4.7°		2.17	70	2		-	-	20.8	23.7	○						
PM-2BC30-R0.50-M20			20		5.0°		2.78	70	2		-	-	-	21.2	○						
PM-2BC50-R0.50-M20			20		5.7°		4.01	70	2		-	-	-	-	○						
PM-2BC05-R0.60-M12			1.2		0.60		0.5°	1.2	12		2.7	5.6°	1.31	60	6	2	12.4	13.1	14.6	16.6	●
PM-2BC05-R0.60-M24									24			3.8°	1.52	70		2	24.4	25.7	28.8	32.8	○
PM-2BC10-R0.60-M12	12	5.7°		1.47		60			2	-		12.5	14.0	15.9		○					
PM-2BC10-R0.60-M24	24	3.9°		1.89		70	2		-	24.5		27.5	31.3	○							
PM-2BC15-R0.60-M12	12	5.8°		1.63		60	2		-	-		13.4	15.2	●							
PM-2BC15-R0.60-M24	24	4.1°		2.26		70	2		-	-		26.2	29.8	○							

B

Solid Carbide end mills
Vollhartmetallschaftfräser

Material Overview · Material Übersicht

✓ = Very suitable · Sehr empfohlen
✓ = Suitable · Empfohlen

KMG405

		Workpiece material Werkstückstoff									
Carbon steel Kohlenstoff Stahl	Alloy steel Legierter Stahl	Quenched and tempered steel · Vergüteter Stahl		Hardened steel · Gehärteter Stahl		Stainless steel · Rostfreier Stahl	Cast iron, Nodular cast iron Grauguss GGG	Copper alloy Kupfer Leg	Aluminum alloy Alu Leg	Titanium alloy Titan Leg	Heat resist alloy warmfeste Leg
		~40HRC	~50HRC	~55HRC	~68HRC						
✓	✓	✓	✓	✓	✓	✓	✓			✓	✓

Code key B252-B254
ISO Kennzeichen

Cutting data B286-B289
Schnittdaten

Graphics identification & application B253-B255
Graphische Werkzeug- & Anwendungsbeschr.

Order form for non-standard products B534-B535
Bestellformular für Sonderwerkzeuge

Milling · Fräsen

Solid Carbide end mills · Vollhartmetallschaftfräser

2-flute conical neck ball nose end mills 2-Schneiden Mikro Kugelkopffräser mit konischem Hals



PM-2BC

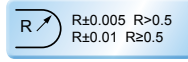
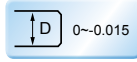
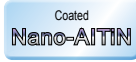
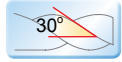
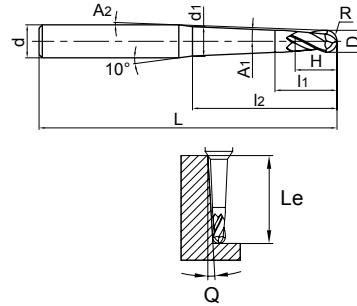

B

Solid Carbide end mills
Vollhartmetallschaftfräser

Type Typ	Dimension(mm) Abmessungen										Teeth Zähne Z	Q Δ Le				Grade Sorte KMG 405	
	D	R	A1	H	l2	l1	A2	d1	L	d		0.5°	1°	2°	3°		
PM-2BC05-R0.75-M10	1.5	0.75	0.5°	1.5	10	3	5.9°	1.57	60	6	2	10.4	10.9	12.2	13.8	○	
PM-2BC05-R0.75-M15					15		4.9°	1.65			60	2	15.4	16.2	18.1	20.6	●
PM-2BC05-R0.75-M30					30		3.2°	1.92			70	2	30.4	32.0	35.9	40.9	○
PM-2BC10-R0.75-M10	1.5	0.75	1.0°	1.5	10	3	6.0°	1.69	60	6	2	-	10.5	11.8	13.3	○	
PM-2BC10-R0.75-M15					15		5.0°	1.86			60	2	-	15.5	17.4	19.7	○
PM-2BC10-R0.75-M20					20		4.2°	2.04			70	2	-	20.5	23.0	26.1	●
PM-2BC10-R0.75-M30	1.5	0.75	1.0°	1.5	30	3	3.3°	2.39	70	6	2	-	30.5	34.2	39.0	○	
PM-2BC15-R0.75-M10					10		6.1°	1.81			60	2	-	-	11.3	12.8	○
PM-2BC15-R0.75-M15					15		5.1°	2.07			60	2	-	-	16.6	18.9	○
PM-2BC15-R0.75-M30	1.5	0.75	1.5°	1.5	30	3	3.4°	2.86	70	6	2	-	-	32.5	37.0	●	
PM-2BC05-R1.0-M20					20		3.9°	2.18			60	2	20.7	21.7	24.3	27.6	●
PM-2BC05-R1.0-M30					30		2.9°	2.36			70	2	30.7	32.3	36.2	no interference	○
PM-2BC05-R1.0-M40	2.0	1.0	0.5°	2.0	40	4	2.4°	2.53	80	6	2	40.7	42.8	48.0	no interference	●	
PM-2BC10-R1.0-M20					20		4.0°	2.46			60	2	-	20.8	23.3	26.4	●
PM-2BC10-R1.0-M25					25		3.4°	2.64			60	2	-	25.8	28.9	32.9	●
PM-2BC10-R1.0-M30	2.0	1.0	1.0°	2.0	30	4	3.0°	2.81	70	6	2	-	30.8	34.5	39.3	●	
PM-2BC10-R1.0-M35					35		2.7°	2.99			80	2	-	35.8	40.1	no interference	●
PM-2BC10-R1.0-M40					40		2.5°	3.16			80	2	-	40.8	45.8	no interference	●
PM-2BC10-R1.0-M50	2.0	1.0	1.5°	2.0	50	4	2.1°	3.51	90	6	2	-	50.8	57.0	no interference	●	
PM-2BC15-R1.0-M20					20		4.1°	2.74			60	2	-	-	22.3	25.3	○
PM-2BC15-R1.0-M30					30		3.1°	3.27			70	2	-	-	32.9	37.4	●
PM-2BC15-R1.0-M40	2.0	1.0	2°	2	40	4	2.6°	3.79	80	6	2	-	-	43.5	no interference	○	
PM-2BC20-R1.0-M30					30		3.3°	3.72			70	2	-	-	31.3	35.5	○
PM-2BC20-R1.0-M40					40		2.7°	4.42			80	2	-	-	41.3	no interference	○
PM-2BC30-R1.0-M30	2.0	1.0	3°	2	30	4	3.5°	4.63	70	6	2	-	-	-	31.8	○	
PM-2BC30-R1.0-M40					40		2.9°	5.68			80	2	-	-	-	no interference	●

✓ = Very suitable · Sehr empfohlen
 ✓ = Suitable · Empfohlen

Material Overview · Material Übersicht

KMG405	Workpiece material Werkstückstoff											
	Carbon steel Kohlenstoff Stahl	Alloy steel Legierter Stahl	Quenched and tempered steel · Vergüteter Stahl		Hardened steel · Gehärteter Stahl		Stainless steel · Rostfreier Stahl	Cast iron, Nodular cast iron Grauguss GGG	Copper alloy Kupfer Leg	Aluminum alloy Alu Leg	Titanium alloy Titan Leg	Heat resist alloy warmfeste Leg
			~40HRC	~50HRC	~55HRC	~68HRC						
✓	✓	✓	✓	✓	✓	✓	✓	✓	✓	✓	✓	✓

● Ex Stock / ab Lager ○ On demand / auf Anfrage

2-flute conical neck ball nose end mills 2-Schneiden Mikro Kugelkopffräser mit konischem Hals



PM-2BC

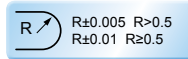
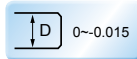
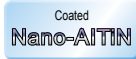
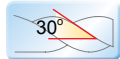
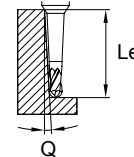
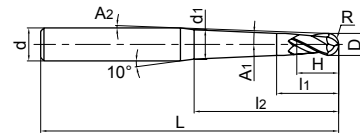

Type Typ	Dimension(mm) Abmessungen										Teeth Zähne Z	Q $\hat{=}$ Le				Grade Sorte KMG 405
	D	R	A1	H	l2	l1	A2	d1	L	d		0.5°	1°	2°	3°	
PM-2BC05-R1.5-M30	3.0	1.5	0.5°	3	30	6	2.4°	3.32	70	6	2	30.7	32.3	36.2	no interference	○
PM-2BC05-R1.5-M40					40		1.9°	3.50	80		2	40.7	42.9	no interference	no interference	●
PM-2BC05-R1.5-M50					50		1.6°	3.67	90		2	50.7	53.4	no interference	no interference	●
PM-2BC10-R1.5-M30			1.0°		30		2.5°	3.74	70		2	-	31.0	34.7	no interference	○
PM-2BC10-R1.5-M40					40		2.0°	4.09	80		2	-	41.0	45.9	no interference	●
PM-2BC10-R1.5-M50					50		1.7°	4.44	90		2	-	51.0	no interference	no interference	○
PM-2BC15-R1.5-M30			1.5°		30		2.6°	4.16	70		2	-	-	33.1	no interference	●
PM-2BC15-R1.5-M40					40		2.1°	4.69	80		2	-	-	43.8	no interference	●
PM-2BC15-R1.5-M50					50		1.7°	5.21	90		2	-	-	no interference	no interference	●
PM-2BC05-R2.0-M60			4.0		2.0		0.5°	4	60		7	1.0°	4.83	110	6	2
PM-2BC10-R2.0-M60	1.0°	60		1.0°		5.76	110	2	-	61.1		no interference	no interference	●		

B

Solid Carbide end mills
Vollhartmetallschaftfräser

Material Overview · Material Übersicht

✓ = Very suitable · Sehr empfohlen
✓ = Suitable · Empfohlen

KMG405

Workpiece material Werkstückstoff											
Carbon steel Kohlenstoff Stahl	Alloy steel Legierter Stahl	Quenched and tempered steel · Vergüteter Stahl		Hardened steel · Gehärteter Stahl		Stainless steel · Rostfreier Stahl	Cast iron, Nodular cast iron Grauguss GGG	Copper alloy Kupfer Leg	Aluminum alloy Alu Leg	Titanium alloy Titan Leg	Heat resist alloy warmfeste Leg
		~40HRC	~50HRC	~55HRC	~68HRC						
✓	✓	✓	✓	✓	✓	✓	✓			✓	✓

Code key **B252-B254**
ISO Kennzeichen

Cutting data **B286-B289**
Schnittdaten

Graphics identification & application **B253-B255**
Graphische Werkzeug- & Anwendungsbeschr.

Order form for non-standard products **B534-B535**
Bestellformular für Sonderwerkzeuge

B285

Milling - Fräsen

Solid Carbide end mills - Vollhartmetallschaftfräser

Recommended cutting data - Empfohlene Schnittdaten

PM-2B | PM-2BL | PM-2BFP (normal)

Workpiece material Werkstückmaterial	Cast iron, Carbon steel, Alloy steel Kohlenstoffstahl Leg. Stahl ~30HRC		Stainless steel Rostfreier Stahl		Pre-hardened steel, Quenched and tempered steel Vergüteter Stahl ~40HRC		Pre-hardened steel, Quenched and tempered steel Vergüteter Stahl ~50HRC		Hardened steel Gehärteter Stahl ~55HRC	
	Diameter Ø Durchmesser (mm)	Rotating Drehzahl (min ⁻¹)	Feed Vorschub (mm/min)	Rotating Drehzahl (min ⁻¹)	Feed Vorschub (mm/min)	Rotating Drehzahl (min ⁻¹)	Feed Vorschub (mm/min)	Rotating Drehzahl (min ⁻¹)	Feed Vorschub (mm/min)	Rotating Drehzahl (min ⁻¹)
R0.5	40000	960	22300	240	32000	385	25000	330	22280	295
R1.0	24000	1080	11150	275	16000	480	13000	330	11140	295
R1.5	15500	1150	7400	350	10600	545	8500	335	7430	295
R2.0	11500	1150	5550	445	8000	665	6500	450	5570	385
R2.5	9500	1270	4450	445	6400	665	5000	455	4455	405
R3.0	8000	1270	3700	470	5300	700	4200	470	3715	420
R4.0	6000	1575	2750	550	4000	850	3200	535	2785	465
R5.0	4800	1455	2200	520	3200	785	2500	535	2230	465
R6.0	4000	1330	1850	520	2650	740	2100	505	1855	450
R8.0	3000	1270	1350	455	2000	725	1600	455	1395	395
R10.0	2400	1150	1100	445	1600	675	1250	400	1115	360

Max. cutting depth max Schnitttiefe	
--	--

1. Please select high precise machine and tool holder.
2. Please use air blow or MQL (minimum oil mist cooling).
3. Vibration and unusual noise may be generated if the machine rigidity and workpiece fixture stability is low, please reduce the rotating speed and feed rate like mentioned above.
4. Make overhang as short as possible if no interference.

1. Bitte präzise Maschinen und Werkzeughalter verwenden.
2. Als Kühlmittel bitte Luft oder MQL (Minimalmengen) verwenden.
3. Bei Vibrationen oder unüblichen Geräuschen reduzieren Sie die Schnittdaten (wie oben empfohlen) entsprechend.
4. Werkzeugauskrantung so kurz wie möglich wählen.

B

Solid Carbide end mills
Vollhartmetallschaftfräser

Recommended cutting data · Empfohlene Schnittdaten

PM-2B | PM-2BL | PM-2BFP (highspeed)

Workpiece material Werkstückmaterial	Cast iron, Carbon steel, Alloy steel Kohlenstoffstahl Leg. Stahl ~30HRC		Stainless steel Rostfreier Stahl		Pre-hardened steel, Quenched and tempered steel Vergüteter Stahl ~45HRC		Pre-hardened steel, Quenched and tempered steel Vergüteter Stahl ~50HRC		Hardened steel Gehärteter Stahl ~55HRC		
	Diameter Ø Durchmesse (mm)	Rotating Drehzahl (min ⁻¹)	Feed Vorschub (mm/min)	Rotating Drehzahl (min ⁻¹)	Feed Vorschub (mm/min)	Rotating Drehzahl (min ⁻¹)	Feed Vorschub (mm/min)	Rotating Drehzahl (min ⁻¹)	Feed Vorschub (mm/min)	Rotating Drehzahl (min ⁻¹)	Feed Vorschub (mm/min)
R3.0	15000	4800	11500	2750	9500	2250	7960	1885	6370	1510	
R4.0	11500	3650	8950	2100	7150	1700	5970	1420	4775	1135	
R5.0	9500	3000	7150	1700	5700	1350	4775	1130	3820	905	
R6.0	7950	2500	5950	1400	4750	1100	3980	920	3180	735	
R8.0	5950	1900	4450	1050	3550	850	2985	760	2390	610	
R10.0	4750	1500	3550	850	2850	680	2390	570	1910	455	
Max. cutting depth max. Schnitttiefe											

1. Please select high precise machine and tool holder.
2. Please use air blow or MQL (minimum oil mist cooling).
3. Vibration and unusual noise may be generated if the machine rigidity and workpiece fixture stability is low, please reduce the rotating speed and feed rate like mentioned above.
4. Make overhang as short as possible if no interference.

1. Bitte präzise Maschinen und Werkzeughalter verwenden.
2. Als Kühlmittel bitte Luft oder MQL (Minimalmengen) verwenden.
3. Bei Vibrationen oder unüblichen Geräuschen reduzieren Sie die Schnittdaten (wie oben empfohlen) entsprechend.
4. Werkzeugauskragung so kurz wie möglich wählen.

Milling - Fräsen

Solid Carbide end mills - Vollhartmetallschaftfräser

Recommended cutting data - Empfohlene Schnittdaten

PM-2BC

Workpiece material Werkstückmaterial			Pre-hardened steel, Quenched and tempered steel Vergüteter Stahl ~40HRC			Pre-hardened steel, Quenched and tempered steel Vergüteter Stahl ~50HRC			Hardened steel Gehärteter Stahl ~55HRC		
Diameter Ø Durchmesser (mm)	A ₁	L ₂	Rotating Drehzahl (min ⁻¹)	Feed Vorschub (mm/min)	a _p (mm)	Rotating Drehzahl (min ⁻¹)	Feed Vorschub (mm/min)	a _p (mm)	Rotating Drehzahl (min ⁻¹)	Feed Vorschub (mm/min)	a _p (mm)
R0.25	0.5°	3	30000	300	0.03	30000	270	0.03	30000	240	0.03
		5	30000	250	0.02	30000	225	0.02	30000	200	0.02
	1.0°	3	30000	330	0.03	30000	300	0.03	30000	265	0.03
		5	30000	270	0.02	30000	245	0.02	30000	215	0.02
	1.5°	3	30000	350	0.03	30000	315	0.03	30000	280	0.03
		5	30000	300	0.02	30000	270	0.02	30000	240	0.02
R0.30	0.5°	5	30000	300	0.03	30000	270	0.03	30000	240	0.03
		8	30000	250	0.02	30000	225	0.02	30000	200	0.02
		5	30000	350	0.03	30000	315	0.03	30000	280	0.03
	1.0°	8	30000	300	0.02	30000	270	0.02	30000	240	0.02
		10	30000	270	0.02	30000	245	0.02	30000	215	0.02
		12	30000	250	0.015	30000	225	0.015	30000	200	0.015
		15	30000	250	0.01	30000	225	0.01	30000	200	0.01
	1.5°	8	30000	350	0.03	30000	315	0.03	30000	280	0.03
		15	30000	300	0.01	30000	270	0.01	30000	240	0.01
		8	30000	350	0.05	30000	315	0.05	30000	280	0.05
R0.40	0.5°	12	30000	300	0.04	30000	270	0.04	30000	240	0.04
		8	30000	400	0.05	30000	360	0.05	30000	320	0.05
	1.0°	12	30000	350	0.04	30000	315	0.04	30000	280	0.04
		8	30000	450	0.05	30000	405	0.05	30000	360	0.05
	1.5°	12	30000	400	0.04	30000	360	0.04	30000	320	0.04
		10	22000	450	0.05	22000	405	0.05	22000	360	0.05
R0.50	0.5°	15	22000	400	0.04	22000	360	0.04	22000	320	0.04
		20	22000	370	0.03	22000	335	0.03	22000	295	0.03
		25	22000	350	0.01	22000	315	0.01	22000	280	0.01
		30	22000	320	0.005	22000	290	0.005	22000	255	0.005
		10	22000	500	0.05	22000	450	0.05	22000	400	0.05
	1.0°	15	22000	450	0.04	22000	405	0.04	22000	360	0.04
		20	22000	430	0.02	22000	390	0.02	22000	345	0.02
		25	22000	400	0.015	22000	360	0.015	22000	320	0.015
		30	22000	360	0.01	22000	325	0.01	22000	290	0.01
		35	22000	320	0.005	22000	290	0.005	22000	255	0.005

Max. cutting depth
max Schnitttiefe

$\le 0.1R (R < 0.5)$
 $\le 0.2R (R \ge 0.5)$

B

Solid Carbide end mills
Vollhartmetallschaftfräser

Recommended cutting data · Empfohlene Schnittdaten

PM-2BC

Workpiece material Werkstück-material			Pre-hardened steel, Quenched and tempered steel Vergüteter Stahl ~40HRC			Pre-hardened steel, Quenched and tempered steel Vergüteter Stahl ~50HRC			Hardened steel Gehärteter Stahl ~55HRC		
Diameter Ø Durchmesser (mm)	A1	L2	Rotating Drehzahl (min ⁻¹)	Feed Vorschub (mm/min)	a _p (mm)	Rotating Drehzahl (min ⁻¹)	Feed Vorschub (mm/min)	a _p (mm)	Rotating Drehzahl (min ⁻¹)	Feed Vorschub (mm/min)	a _p (mm)
R1.0	1.5°	20	18000	1000	0.05	18000	900	0.05	18000	800	0.05
		30	18000	900	0.03	18000	810	0.03	18000	720	0.03
		40	18000	750	0.03	18000	675	0.03	18000	600	0.03
	2°	30	18000	900	0.04	18000	810	0.04	18000	720	0.04
		40	18000	850	0.03	18000	765	0.03	18000	680	0.03
	3°	30	18000	1000	0.04	18000	900	0.04	18000	800	0.04
40		18000	900	0.03	18000	810	0.03	18000	720	0.03	
R1.5	0.5°	30	16000	1100	0.1	16000	990	0.1	16000	880	0.1
		40	16000	950	0.06	16000	855	0.06	16000	760	0.06
		50	16000	800	0.03	16000	720	0.03	16000	640	0.03
	1.0°	30	16000	1200	0.1	16000	1080	0.1	16000	960	0.1
		40	16000	1000	0.06	16000	900	0.06	16000	800	0.06
		50	16000	850	0.03	16000	765	0.03	16000	680	0.03
R1.5	1.5°	30	16000	1300	0.1	16000	1170	0.1	16000	1040	0.1
		40	16000	1100	0.06	16000	990	0.06	16000	880	0.06
		50	16000	950	0.03	16000	855	0.03	16000	760	0.03
R2.0	0.5°	60	14000	1100	0.1	14000	990	0.1	14000	880	0.1
	1.0°	60	14000	1100	0.1	14000	990	0.1	14000	880	0.1

Max. cutting depth
max. Schnitttiefe

$\leq 0.1R (R < 0.5)$
 $\leq 0.2R (R \geq 0.5)$

1. Please select high precise machine and tool holder. If vibration and unusual noise occurs please reduce the a_p and check the stability of machine and clamping system.
2. Please use air blow or MQL (minimum oil mist cooling).
3. Please reduce the feed rate when rotating speed is low.
4. The above table shows parameter for ideal condition. Please check your system and adapt the parameter.

1. Bitte präzise Maschinen und Werkzeughalter verwenden. Bei Vibrationen oder ungewöhnlichen Geräuschen reduzieren Sie a_p.
2. Als Kühlmittel bitte Luft oder MQL (Minimalmengen) verwenden.
3. Bitte Vorschub entsprechend reduzieren, wenn die Drehzahlen niedrig ist.
4. Die Angaben in der Tabelle beziehen sich auf ideale Bearbeitungsbedingungen. Bitte Ihr System überprüfung und die Werte gegebenenfalls anpassen.

Milling · Fräsen

Solid Carbide end mills · Vollhartmetallschaftfräser

4-flute ball nose end mills with straight shank 4-Schneiden Kugelkopffräser mit Zylinderschaft



PM-4B

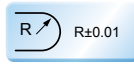
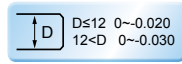
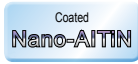
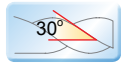
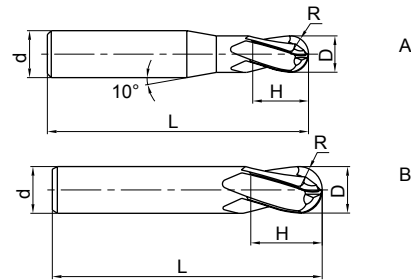

Type Typ	Dimension (mm) Abmessungen					Teeth Zähne Z	Geometry Ausführung	Grade Sorte KMG 405
	D	R	d	H	L			
PM-4B-R1.5	3.0	1.5	6	6	50	4	A	●
PM-4B-R2.0	4.0	2.0	6	8	50	4	A	●
PM-4B-R2.5	5.0	2.5	6	10	50	4	A	●
PM-4B-R3.0	6.0	3.0	6	12	50	4	B	●
PM-4B-R4.0	8.0	4.0	8	16	60	4	B	●
PM-4B-R5.0	10.0	5.0	10	20	75	4	B	●
PM-4B-R6.0	12.0	6.0	12	24	75	4	B	●
PM-4B-R7.0	14.0	7.0	14	28	75	4	B	●
PM-4B-R8.0	16.0	8.0	16	32	100	4	B	●
PM-4B-R9.0	18.0	9.0	18	36	100	4	B	●
PM-4B-R10.0	20.0	10.0	20	40	100	4	B	●

B

Solid Carbide end mills
Vollhartmetallschaftfräser

Material Overview · Material Übersicht

✓ = Very suitable · Sehr empfohlen
✓ = Suitable · Empfohlen

KMG405

Workpiece material Werkstückstoff											
Carbon steel Kohlenstoff Stahl	Alloy steel Legierter Stahl	Quenched and tempered steel · Vergüteter Stahl		Hardened steel · Gehärteter Stahl		Stainless steel · Rostfreier Stahl	Cast iron, Nodular cast iron Grauguss GGG	Copper alloy Kupfer Leg	Aluminum alloy Alu Leg	Titanium alloy Titan Leg	Heat resist alloy warmfeste Leg
		~40HRC	~50HRC	~55HRC	~68HRC						
✓	✓	✓	✓	✓	✓	✓	✓			✓	✓

● Ex Stock / ab Lager ○ On demand / auf Anfrage

4-flute ball nose end mills with straight shank and long cutting edge 4-Schneiden Kugelnosefräser mit langer Schneide und Zylinderschaft



PM-4BL

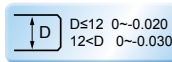
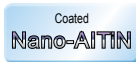
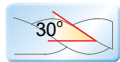
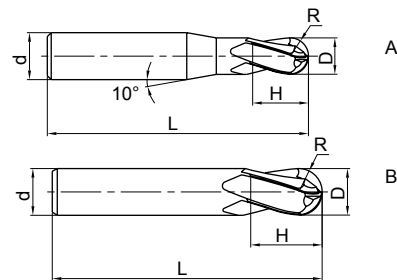

Type Typ	Dimension(mm) Abmessungen					Teeth Zähne Z	Geometry Ausführung	Grade Sorte KMG 405
	D	R	d	H	L			
PM-4BL-R1.5	3.0	1.5	6	6	75	4	A	●
PM-4BL-R2.0	4.0	2.0	6	8	75	4	A	●
PM-4BL-R2.5	5.0	2.5	6	10	75	4	A	●
PM-4BL-R3.0	6.0	3.0	6	12	75	4	B	●
PM-4BL-R4.0	8.0	4.0	8	16	100	4	B	●
PM-4BL-R5.0	10.0	5.0	10	20	100	4	B	●
PM-4BL-R6.0	12.0	6.0	12	24	100	4	B	●
PM-4BL-R7.0	14.0	7.0	14	28	100	4	B	○
PM-4BL-R8.0	16.0	8.0	16	32	150	4	B	●
PM-4BL-R9.0	18.0	9.0	18	36	150	4	B	●
PM-4BL-R10.0	20.0	10.0	20	40	150	4	B	●

B

Solid Carbide end mills
Vollhartmetallschaftfräser

Material Overview · Material Übersicht

✓ = Very suitable · Sehr empfohlen
✓ = Suitable · Empfohlen

KMG405

Workpiece material Werkstückstoff											
Carbon steel Kohlenstoff Stahl	Alloy steel Legierter Stahl	Quenched and tempered steel · Vergüteter Stahl		Hardened steel · Gehärteter Stahl		Stainless steel · Rostfreier Stahl	Cast iron, Nodular cast iron Grauguss GGG	Copper alloy Kupfer Leg	Aluminum alloy Alu Leg	Titanium alloy Titan Leg	Heat resist alloy warmfeste Leg
		~40HRC	~50HRC	~55HRC	~68HRC						
✓	✓	✓	✓	✓	✓	✓	✓			✓	✓

Code key **B252-B254**
ISO Kennzeichen

Cutting data **B292**
Schnittdaten

Graphics identification & application **B253-B255**
Graphische Werkzeug- & Anwendungsbeschr.

Order form for non-standard products **B534-B535**
Bestellformular für Sonderwerkzeuge

Milling · Fräsen

Solid Carbide end mills · Vollhartmetallschaftfräser

Recommended cutting data · Empfohlene Schnittdaten

PM-4B | PM-4BL

Workpiece material Werkstückmaterial	Cast iron, Carbon steel, Alloy steel Kohlenstoffstahl Leg. Stahl ~30HRC		Stainless steel Rostfreier Stahl		Pre-hardened steel, Quenched and tempered steel Vergüteter Stahl ~45HRC		Pre-hardened steel, Quenched and tempered steel Vergüteter Stahl ~50HRC		Hardened steel Gehärteter Stahl ~55HRC	
	Diameter Ø Durchmesser (mm)	Rotating Drehzahl (min ⁻¹)	Feed Vorschub (mm/min)	Rotating Drehzahl (min ⁻¹)	Feed Vorschub (mm/min)	Rotating Drehzahl (min ⁻¹)	Feed Vorschub (mm/min)	Rotating Drehzahl (min ⁻¹)	Feed Vorschub (mm/min)	Rotating Drehzahl (min ⁻¹)
R1.5	15500	2055	7400	625	10600	975	8500	600	7430	525
R2.0	11500	2055	5550	795	8000	1190	6500	800	5570	685
R2.5	9500	2270	4450	795	6400	1190	5000	810	4455	720
R3.0	8000	2270	3700	840	5300	1245	4200	840	3715	745
R4.0	6000	2810	2750	985	4000	1515	3200	950	2785	825
R5.0	4800	2595	2200	925	3200	1405	2500	950	2230	825
R6.0	4000	2375	1850	925	2650	1320	2100	905	1855	800
R8.0	3000	2270	1350	815	2000	1295	1600	810	1395	705
R10.0	2400	2055	1100	795	1600	1200	1250	715	1115	640

Max. cutting depth max Schnitttiefe	
--	--

1. Please select high precise machine and tool holder.
2. Please use air blow or MQL (minimum oil mist cooling).
3. Vibration and unusual noise may be generated if the machine rigidity and workpiece fixture stability is low, please reduce the rotating speed and feed rate like mentioned above.
4. Make overhang as short as possible if no interference.

1. Bitte präzise Maschinen und Werkzeughalter verwenden.
2. Als Kühlmittel bitte Luft oder MQL (Minimalmengen) verwenden.
3. Bei Vibrationen oder unüblichen Geräuschen reduzieren Sie die Schnittdaten (wie oben empfohlen) entsprechend.
4. Werkzeugauskrägung so kurz wie möglich wählen.

● Ex Stock / ab Lager ○ On demand / auf Anfrage

2-flute radius end mills with straight shank 2-Schneiden Radius Schafffräser und Zylinderschaft



PM-2R

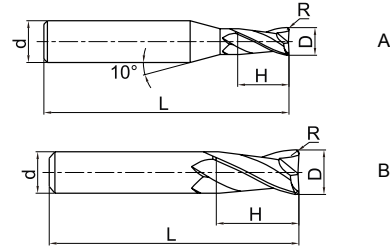

Type Typ	Dimension(mm) Abmessungen					Teeth Zähne Z	Geometry Ausführung	Grade Sorte KMG 405
	D	R	d	H	L			
PM-2R-D1.0R0.2	1.0	0.2	4	3	50	2	A	●
PM-2R-D1.5R0.2	1.5	0.2	4	4	50	2	A	●
PM-2R-D2.0R0.2	2.0	0.2	4	6	50	2	A	●
PM-2R-D2.0R0.5	2.0	0.5	4	6	50	2	A	●
PM-2R-D2.5R0.2	2.5	0.2	4	8	50	2	A	●
PM-2R-D2.5R0.5	2.5	0.5	4	8	50	2	A	●
PM-2R-D3.0R0.2	3.0	0.2	4	8	50	2	A	●
PM-2R-D3.0R0.3	3.0	0.3	4	8	50	2	A	○
PM-2R-D3.0R0.5	3.0	0.5	4	8	50	2	A	●
PM-2R-D4.0R0.2	4.0	0.2	4	11	50	2	B	●
PM-2R-D4.0R0.3	4.0	0.3	4	11	50	2	B	●
PM-2R-D4.0R0.5	4.0	0.5	4	11	50	2	B	●
PM-2R-D4.0R1.0	4.0	1.0	4	11	50	2	B	●
PM-2R-D5.0R0.3	5.0	0.3	6	13	50	2	A	○
PM-2R-D5.0R0.5	5.0	0.5	6	13	50	2	A	●
PM-2R-D5.0R1.0	5.0	1.0	6	13	50	2	A	●
PM-2R-D6.0R0.3	6.0	0.3	6	16	50	2	B	●
PM-2R-D6.0R0.5	6.0	0.5	6	16	50	2	B	●
PM-2R-D6.0R1.0	6.0	1.0	6	16	50	2	B	●
PM-2R-D8.0R0.3	8.0	0.3	8	20	60	2	B	○
PM-2R-D8.0R0.5	8.0	0.5	8	20	60	2	B	●
PM-2R-D8.0R1.0	8.0	1.0	8	20	60	2	B	●
PM-2R-D10.0R0.5	10.0	0.5	10	25	75	2	B	●
PM-2R-D10.0R1.0	10.0	1.0	10	25	75	2	B	●
PM-2R-D10.0R1.5	10.0	1.5	10	25	75	2	B	●
PM-2R-D10.0R2.0	10.0	2.0	10	25	75	2	B	●
PM-2R-D12.0R0.5	12.0	0.5	12	30	75	2	B	●
PM-2R-D12.0R1.0	12.0	1.0	12	30	75	2	B	●
PM-2R-D12.0R1.5	12.0	1.5	12	30	75	2	B	●
PM-2R-D12.0R2.0	12.0	2.0	12	30	75	2	B	●

Material Overview · Material Übersicht

✓ = Very suitable · Sehr empfohlen
 ✓ = Suitable · Empfohlen

KMG405

Workpiece material Werkstückstoff											
Carbon steel Kohlenstoff Stahl	Alloy steel Legierter Stahl	Quenched and tempered steel · Vergüteter Stahl		Hardened steel · Gehärteter Stahl		Stainless steel · Rostfreier Stahl	Cast iron, Nodular cast iron Grauguss GGG	Copper alloy Kupfer Leg	Aluminum alloy Alu Leg	Titanium alloy Titan Leg	Heat resist alloy warmfeste Leg
		~40HRC	~50HRC	~55HRC	~68HRC						
✓	✓	✓	✓	✓	✓	✓	✓			✓	✓

Code key B252,B254
ISO Kennzeichen

Cutting data B294
Schnittdaten

Graphics identification & application B253-B255
Graphische Werkzeug- & Anwendungsbeschr.

Order form for non-standard products B534-B535
Bestellformular für Sonderwerkzeuge

Milling - Fräsen

Solid Carbide end mills · Vollhartmetallschaftfräser

Recommended cutting data · Empfohlene Schnittdaten

PM-2R

Workpiece material Werkstückmaterial	Cast iron, Carbon steel, Alloy steel Kohlenstoffstahl Leg. Stahl ~30HRC		Stainless steel Rostfreier Stahl		Pre-hardened steel, Quenched and tempered steel Vergüteter Stahl ~40HRC		Pre-hardened steel, Quenched and tempered steel Vergüteter Stahl ~50HRC		Hardened steel Gehärteter Stahl ~55HRC	
	Diameter Ø Durchmesser (mm)	Rotating Drehzahl (min ⁻¹)	Feed Vorschub (mm/min)	Rotating Drehzahl (min ⁻¹)	Feed Vorschub (mm/min)	Rotating Drehzahl (min ⁻¹)	Feed Vorschub (mm/min)	Rotating Drehzahl (min ⁻¹)	Feed Vorschub (mm/min)	Rotating Drehzahl (min ⁻¹)
1	20000	240	20000	75	20000	195	20000	145	20000	95
2	15000	385	11150	100	15000	335	13000	215	11140	130
3	14000	655	7500	145	10600	505	8500	395	7430	245
4	10800	675	5500	155	8000	515	6500	405	5570	245
5	8200	695	4500	155	6400	540	5000	425	4460	260
6	7000	720	3700	170	5300	555	4200	435	3710	260
8	5200	720	2800	170	4000	555	3200	440	2785	275
10	4200	695	2200	170	3200	535	2500	420	2230	255
12	3500	695	1850	170	2650	535	2100	420	1855	255

Max. cutting depth max Schnitttiefe																			
	<table border="1"> <thead> <tr> <th>Milling slot</th> <th>Nutenfräsen</th> </tr> <tr> <th>Ø</th> <th>Ap</th> </tr> </thead> <tbody> <tr> <td>Ø1 ≤ D < Ø3</td> <td>0.15D</td> </tr> <tr> <td>Ø3 ≤ D < Ø6</td> <td>0.3D</td> </tr> <tr> <td>Ø6 ≤ D < Ø20</td> <td>0.5D</td> </tr> </tbody> </table>	Milling slot	Nutenfräsen	Ø	Ap	Ø1 ≤ D < Ø3	0.15D	Ø3 ≤ D < Ø6	0.3D	Ø6 ≤ D < Ø20	0.5D	<table border="1"> <thead> <tr> <th>Milling slot</th> <th>Nutenfräsen</th> </tr> <tr> <th>Ø</th> <th>Ap</th> </tr> </thead> <tbody> <tr> <td>Ø1 ≤ D < Ø3</td> <td>0.1D</td> </tr> <tr> <td>Ø3 ≤ D</td> <td>0.2D</td> </tr> </tbody> </table>	Milling slot	Nutenfräsen	Ø	Ap	Ø1 ≤ D < Ø3	0.1D	Ø3 ≤ D
Milling slot	Nutenfräsen																		
Ø	Ap																		
Ø1 ≤ D < Ø3	0.15D																		
Ø3 ≤ D < Ø6	0.3D																		
Ø6 ≤ D < Ø20	0.5D																		
Milling slot	Nutenfräsen																		
Ø	Ap																		
Ø1 ≤ D < Ø3	0.1D																		
Ø3 ≤ D	0.2D																		

- The above table shows the standard value of side milling. When slot milling, of rotating speed 50%~70% and feed rate like mentioned above 40%~60%.
- Please select high precise machine and tool holder.
- Please use air blow or cutting liquid with high mist retardant property.
- Down milling is recommended in side milling.
- Vibration and unusual noise may be generated if the machine rigidity and workpiece fixture stability is low, please reduce the rotating speed and feed rate like mentioned above.
- Make overhang as short as possible if no interference.

- Die obige Tabelle zeigt Standard Werte für das Eckfräsen. Bei Nutenfräsen, Schnittgeschwindigkeit auf 50-70% und den Vorschub auf 40-60% reduzieren.
- Bitte präzise Maschinen und Werkzeughalter verwenden.
- Bitte Luftkühlung oder Schneidflüssigkeit benutzen.
- Empfohlene Fräsmethode: Gleichlaufräsen.
- Bei Vibrationen oder unüblichen Geräuschen reduzieren Sie die Schnittdaten (wie oben empfohlen) entsprechend.
- Werkzeugauskragung so kurz wie möglich wählen.

● Ex Stock / ab Lager ○ On demand / auf Anfrage

4-flute radius end mills with straight shank 4-Schneiden Radius Schafffräser und Zylinderschaft



PM-4R

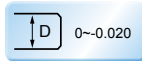
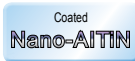
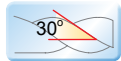
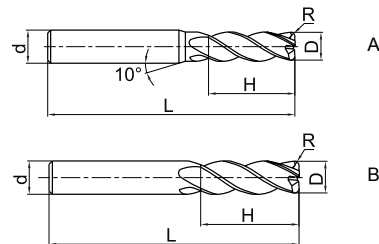

Type Typ	Dimension(mm) Abmessungen					Teeth Zähne Z	Geometry Ausführung	Grade Sorte KMG 405
	D	R	d	H	L			
PM-4R-D3.0R0.2	3.0	0.2	6	8	50	4	A	●
PM-4R-D4.0R0.3	4.0	0.3	6	10	50	4	A	●
PM-4R-D4.0R0.5	4.0	0.5	6	10	50	4	A	●
PM-4R-D5.0R0.5	5.0	0.5	6	13	50	4	A	●
PM-4R-D5.0R1.0	5.0	1.0	6	13	50	4	A	●
PM-4R-D6.0R0.5	6.0	0.5	6	16	50	4	B	●
PM-4R-D6.0R1.0	6.0	1.0	6	16	50	4	B	●
PM-4R-D8.0R0.5	8.0	0.5	8	20	60	4	B	●
PM-4R-D8.0R1.0	8.0	1.0	8	20	60	4	B	●
PM-4R-D10.0R0.5	10.0	0.5	10	25	75	4	B	●
PM-4R-D10.0R1.0	10.0	1.0	10	25	75	4	B	●
PM-4R-D10.0R2.0	10.0	2.0	10	25	75	4	B	●
PM-4R-D10.0R3.0	10.0	3.0	10	25	75	4	B	●
PM-4R-D12.0R0.5	12.0	0.5	12	30	75	4	B	●
PM-4R-D12.0R1.0	12.0	1.0	12	30	75	4	B	●
PM-4R-D12.0R2.0	12.0	2.0	12	30	75	4	B	●
PM-4R-D12.0R3.0	12.0	3.0	12	30	75	4	B	●

B

Solid Carbide end mills
Vollhartmetallschaftfräser

Material Overview · Material Übersicht

✓ = Very suitable · Sehr empfohlen
✓ = Suitable · Empfohlen

KMG405

Workpiece material Werkstückstoff											
Carbon steel Kohlenstoff Stahl	Alloy steel Legierter Stahl	Quenched and tempered steel · Vergüteter Stahl		Hardened steel · Gehärteter Stahl		Stainless steel · Rostfreier Stahl	Cast iron, Nodular cast iron Grauguss GGG	Copper alloy Kupfer Leg	Aluminum alloy Alu Leg	Titanium alloy Titan Leg	Heat resist alloy warmfeste Leg
		~40HRC	~50HRC	~55HRC	~68HRC						
✓	✓	✓	✓	✓	✓	✓	✓			✓	✓

Code key **B252,B254**
ISO Kennzeichen

Cutting data **B297**
Schnittdaten

Graphics identification & application **B253-B255**
Graphische Werkzeug- & Anwendungsbeschr.

Order form for non-standard products **B534-B535**
Bestellformular für Sonderwerkzeuge

Milling · Fräsen

Solid Carbide end mills · Vollhartmetallschaftfräser

4-flute radius end mills with straight shank
4-Schneiden Radius Schaftfräser und Zylinderschaft



PM-4RL

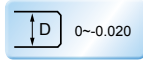
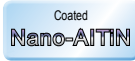
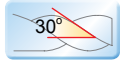
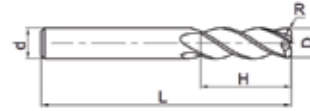

Type Typ	Dimension(mm) Abmessungen					Teeth Zähne Z	Grade Sorte KMG 405
	D	R	d	H	L		
PM-4RL-D6.0R0.5	6.0	0.5	6	16	75	4	●
PM-4RL-D6.0R1.0	6.0	1.0	6	16	75	4	●
PM-4RL-D8.0R0.5	8.0	0.5	8	20	100	4	●
PM-4RL-D8.0R1.0	8.0	1.0	8	20	100	4	●
PM-4RL-D10.0R0.5	10.0	0.5	10	25	100	4	●
PM-4RL-D10.0R1.0	10.0	1.0	10	25	100	4	●
PM-4RL-D10.0R2.0	10.0	2.0	10	25	100	4	●
PM-4RL-D12.0R0.5	12.0	0.5	12	30	100	4	●
PM-4RL-D12.0R1.0	12.0	1.0	12	30	100	4	●
PM-4RL-D12.0R2.0	12.0	2.0	12	30	100	4	●
PM-4RL-D16.0R1.0	16.0	1.0	16	45	150	4	●
PM-4RL-D16.0R2.0	16.0	2.0	16	45	150	4	●

B

Solid Carbide end mills
Vollhartmetallschaftfräser

Material Overview · Material Übersicht

✓ = Very suitable · Sehr empfohlen
✓ = Suitable · Empfohlen

KMG405

Workpiece material Werkstückstoff											
Carbon steel Kohlenstoff Stahl	Alloy steel Legierter Stahl	Quenched and tempered steel · Vergüteter Stahl		Hardened steel · Gehärteter Stahl		Stainless steel · Rostfreier Stahl	Cast iron, Nodular cast iron Grauguss GGG	Copper alloy Kupfer Leg	Aluminum alloy Alu Leg	Titanium alloy Titan Leg	Heat resist alloy warmfeste Leg
		~40HRC	~50HRC	~55HRC	~68HRC						
✓	✓	✓	✓	✓		✓	✓			✓	✓

● Ex Stock / ab Lager ○ On demand / auf Anfrage

Recommended cutting data · Empfohlene Schnittdaten

PM-4R | PM-4RL

Workpiece material Werkstückmaterial	Cast iron, Carbon steel, Alloy steel Kohlenstoffstahl Leg. Stahl ~30HRC		Stainless steel Rostfreier Stahl		Pre-hardened steel, Quenched and tempered steel Vergüteter Stahl ~40HRC		Pre-hardened steel, Quenched and tempered steel Vergüteter Stahl ~50HRC		Hardened steel Gehärteter Stahl ~55HRC	
	Diameter Ø Durchmesser (mm)	Rotating Drehzahl (min ⁻¹)	Feed Vorschub (mm/min)	Rotating Drehzahl (min ⁻¹)	Feed Vorschub (mm/min)	Rotating Drehzahl (min ⁻¹)	Feed Vorschub (mm/min)	Rotating Drehzahl (min ⁻¹)	Feed Vorschub (mm/min)	Rotating Drehzahl (min ⁻¹)
3	14000	985	7500	175	10600	755	8500	590	7430	435
4	10800	1010	5500	175	8000	770	6500	600	5570	445
5	8200	1055	4500	175	6400	805	5000	640	4460	470
6	7000	1080	3700	195	5300	830	4200	650	3710	470
8	5200	1070	2800	195	4000	815	3200	660	2785	485
10	4200	1055	2200	195	3200	805	2500	625	2230	450
12	3500	1055	1850	195	2650	805	2100	625	1855	450
16	2600	985	1400	175	2000	755	1600	590	1390	435

Max. cutting depth max. Schnitttiefe																			
	<table border="1"> <thead> <tr> <th>Milling slot</th> <th>Nutenfräsen</th> </tr> <tr> <th>Ø</th> <th>Ap</th> </tr> </thead> <tbody> <tr> <td>Ø1≤D<Ø3</td> <td>0.15D</td> </tr> <tr> <td>Ø3≤D<Ø6</td> <td>0.3D</td> </tr> <tr> <td>Ø6≤D<Ø20</td> <td>0.5D</td> </tr> </tbody> </table>	Milling slot	Nutenfräsen	Ø	Ap	Ø1≤D<Ø3	0.15D	Ø3≤D<Ø6	0.3D	Ø6≤D<Ø20	0.5D	<table border="1"> <thead> <tr> <th>Milling slot</th> <th>Nutenfräsen</th> </tr> <tr> <th>Ø</th> <th>Ap</th> </tr> </thead> <tbody> <tr> <td>Ø1≤D<Ø3</td> <td>0.1D</td> </tr> <tr> <td>Ø3≤D</td> <td>0.2D</td> </tr> </tbody> </table>	Milling slot	Nutenfräsen	Ø	Ap	Ø1≤D<Ø3	0.1D	Ø3≤D
Milling slot	Nutenfräsen																		
Ø	Ap																		
Ø1≤D<Ø3	0.15D																		
Ø3≤D<Ø6	0.3D																		
Ø6≤D<Ø20	0.5D																		
Milling slot	Nutenfräsen																		
Ø	Ap																		
Ø1≤D<Ø3	0.1D																		
Ø3≤D	0.2D																		

- The above table shows the standard value of side milling. When slot milling, of rotating speed 50%~70% and feed rate like mentioned above 40%~60%.
- Please select high precise machine and tool holder.
- Please use air blow or cutting liquid with high mist retardant property.
- Down milling is recommended in side milling.
- Vibration and unusual noise may be generated if the machine rigidity and workpiece fixture stability is low, please reduce the rotating speed and feed rate like mentioned above.
- Make overhang as short as possible if no interference.

- Die obige Tabelle zeigt Standard Werte für das Eckfräsen. Bei Nutenfräsen, Schnittgeschwindigkeit auf 50-70% und den Vorschub auf 40-60% reduzieren.
- Bitte präzise Maschinen und Werkzeughalter verwenden.
- Bitte Luftkühlung oder Schneidflüssigkeit benutzen.
- Empfohlene Fräsmethode: Gleichlaufräsen.
- Bei Vibrationen oder ungewöhnlichen Geräuschen reduzieren Sie die Schnittdaten (wie oben empfohlen) entsprechend.
- Werkzeugauskragung so kurz wie möglich wählen.

Milling · Fräsen

Solid Carbide end mills · Vollhartmetallschaftfräser

4-flute high feed end mills 4-Schneiden "High Feed" VHM-Fräser



PM-4H

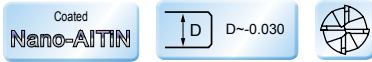
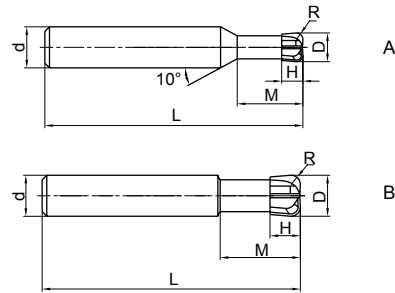

Type Typ	Dimension(mm) Abmessungen							Teeth Zähne Z	Geometry Ausführung	Grade Sorte KMG 405
	D	R	d	d ₁	H	M	L			
PM-4H-D3.0R0.8	3.0	0.8	6	2.7	1.2	8	50	4	A	●
PM-4H-D4.0R1.0	4.0	1.0	6	3.6	1.6	10	50	4	A	●
PM-4H-D5.0R1.2	5.0	1.2	6	4.5	2	12.5	50	4	A	●
PM-4H-D6.0R1.0	6.0	1.0	6	5.4	2.5	12	50	4	B	●
PM-4H-D6.0R1.5	6.0	1.5	6	5.4	2.5	12	50	4	B	●
PM-4H-D6.0R2.0	6.0	2.0	6	5.4	2.5	12	50	4	B	●
PM-4H-D8.0R1.0	8.0	1.0	8	7.0	3.5	16	60	4	B	●
PM-4H-D8.0R2.0	8.0	2.0	8	7.0	3.5	16	60	4	B	●
PM-4H-D10.0R1.0	10.0	1.0	10	9.0	4	20	75	4	B	●
PM-4H-D10.0R2.0	10.0	2.0	10	9.0	4	20	75	4	B	●
PM-4H-D10.0R3.0	10.0	3.0	10	9.0	4	20	75	4	B	●
PM-4H-D12.0R2.0	12.0	2.0	12	11.0	5	24	75	4	B	●
PM-4H-D12.0R3.0	12.0	3.0	12	11.0	5	24	75	4	B	●

B

Solid Carbide end mills
Vollhartmetallschaftfräser

Material Overview · Material Übersicht

✓ = Very suitable · Sehr empfohlen
✓ = Suitable · Empfohlen

KMG405

Workpiece material Werkstückstoff											
Carbon steel Kohlenstoff Stahl	Alloy steel Legierter Stahl	Quenched and tempered steel · Vergüteter Stahl		Hardened steel · Gehärteter Stahl		Stainless steel · Rostfreier Stahl	Cast iron, Nodular cast iron Grauguss GGG	Copper alloy Kupfer Leg	Aluminum alloy Alu Leg	Titanium alloy Titan Leg	Heat resist alloy warmfeste Leg
		~40HRC	~50HRC	~55HRC	~68HRC						
✓	✓	✓	✓	✓		✓	✓			✓	✓

● Ex Stock / ab Lager ○ On demand / auf Anfrage

4-flute high feed end mills 4-Schneiden "High Feed" VHM-Fräser



PM-4HL

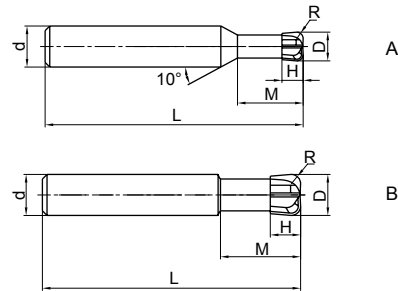

Coated
Nano-AlTiN

D
D₁-0.030



Type Typ	Dimension(mm) Abmessungen							Teeth Zähne Z	Geometry Ausführung	Grade Sorte KMG 405
	D	R	d	d ₁	H	M	L			
PM-4HL-D4.0R1.0	4.0	1.0	6	3.6	1.6	10	75	4	A	●
PM-4HL-D5.0R1.2	5.0	1.2	6	4.5	2	12.5	75	4	A	●
PM-4HL-D6.0R1.0	6.0	1.0	6	5.4	2.5	12	75	4	B	●
PM-4HL-D6.0R1.5	6.0	1.5	6	5.4	2.5	12	75	4	B	●
PM-4HL-D6.0R2.0	6.0	2.0	6	5.4	2.5	12	75	4	B	●
PM-4HL-D8.0R1.0	8.0	1.0	8	7.0	3.5	16	100	4	B	●
PM-4HL-D8.0R2.0	8.0	2.0	8	7.0	3.5	16	100	4	B	●
PM-4HL-D10.0R1.0	10.0	1.0	10	9.0	4	20	100	4	B	●
PM-4HL-D10.0R2.0	10.0	2.0	10	9.0	4	20	100	4	B	●
PM-4HL-D10.0R3.0	10.0	3.0	10	9.0	4	20	100	4	B	●
PM-4HL-D12.0R2.0	12.0	2.0	12	11.0	5	24	100	4	B	●
PM-4HL-D12.0R3.0	12.0	3.0	12	11.0	5	24	100	4	B	●

B

Solid Carbide end mills
Vollhartmetallschaftfräser

Material Overview · Material Übersicht

✓ = Very suitable · Sehr empfohlen
✓ = Suitable · Empfohlen

KMG405

Workpiece material Werkstückstoff											
Carbon steel Kohlenstoff Stahl	Alloy steel Legierter Stahl	Quenched and tempered steel · Vergüteter Stahl		Hardened steel · Gehärteter Stahl		Stainless steel · Rostfreier Stahl	Cast iron, Nodular cast iron Grauguss GGG	Copper alloy Kupfer Leg	Aluminum alloy Alu Leg	Titanium alloy Titan Leg	Heat resist alloy warmfeste Leg
		~40HRC	~50HRC	~55HRC	~68HRC						
✓	✓	✓	✓	✓		✓	✓			✓	✓

Code key **B252-B254**
ISO Kennzeichen

Cutting data **B300-B301**
Schnittdaten

Graphics identification & application **B253-B255**
Graphische Werkzeug- & Anwendungsbeschr.

Order form for non-standard products **B534-B535**
Bestellformular für Sonderwerkzeuge

Milling - Fräsen

Solid Carbide end mills - Vollhartmetallschaftfräser

Recommended cutting data · Empfohlene Schnittdaten

PM-4H | PM-4HL normal

Workpiece material Werkstückmaterial	Cast iron, Carbon steel, Alloy steel Kohlenstoffstahl Leg. Stahl ~30HRC		Quenched and tempered steel Vergüteter Stahl ~40HRC		Quenched and tempered steel Vergüteter Stahl ~45HRC		Quenched and tempered steel Vergüteter Stahl ~50HRC		Quenched and tempered steel Vergüteter Stahl ~55HRC	
	Diameter Ø Durchmesser (mm)	Rotating Drehzahl (min ⁻¹)	Feed Vorschub (mm/min)	Rotating Drehzahl (min ⁻¹)	Feed Vorschub (mm/min)	Rotating Drehzahl (min ⁻¹)	Feed Vorschub (mm/min)	Rotating Drehzahl (min ⁻¹)	Feed Vorschub (mm/min)	Rotating Drehzahl (min ⁻¹)
3.0×R0.8	10500	6250	8500	4500	7450	3900	5300	2600	3200	995
4.0×R1.0	7950	6600	6350	4800	5550	4200	4000	2750	2400	1050
5.0×R1.2	6350	7000	5100	5100	4450	4450	3200	2850	1900	1150
6.0×R1.0 6.0×R1.5	5300	7000	4250	5100	3700	4450	2650	2850	1600	1150
8.0×R1.0 8.0×R2.0	4550	7000	3200	5100	2800	4450	2000	2850	1200	1150
10.0×R1.0 10.0×R2.0	3200	7000	2550	5100	2250	4450	1600	2850	955	1150
12.0×R2.0 12.0×R3.0	2650	7000	2100	5100	1850	4450	1350	2850	795	1150
Max. cutting depth max Schnitttiefe	max a _p =0.5mm						max a _p =0.4mm		max a _p =0.2mm	

1. Please select high precise machine and tool holder.
2. Please use air blow or MQL (minimum oil mist cooling).
3. Down milling is recommended in side milling.
4. Vibration and unusual noise may be generated if the machine rigidity and workpiece fixture stability is low, please reduce the rotating speed and feed rate like mentioned above.
5. Make overhang as short as possible if no interference.
6. For overhang of L/D ≤ 4 please use cutting condition from table above. For bigger overhang see table below.

1. Bitte präzise Maschinen und Werkzeughalter verwenden.
2. Als Kühlmittel bitte Luft oder MQL (Minimalmengen) verwenden.
3. Empfohlene Fräsmethode: Gleichlaufräsen.
4. Bei Vibrationen oder unüblichen Geräuschen reduzieren Sie die Schnittdaten (wie oben empfohlen) entsprechend.
5. Werkzeugauskragung so kurz wie möglich wählen.
6. Für Auskräglängen L/D ≤ 4 bitte die Parameter aus der Tabelle oben verwenden. Für L/D > 4 siehe Tabelle unten.

L/D	V _c (m/min)	a _e (mm)	f _n (mm/min)
L/D ≤ 4	100%	100%	100%
L/D = 5	80%~90%	70%~90%	80%~90%
L/D = 6	60%~80%	50%~70%	60%~80%

Recommended cutting data · Empfohlene Schnittdaten

PM-4H | PM-4HL highspeed

Workpiece material Werkstückmaterial	Cast iron, Carbon steel, Alloy steel Kohlenstoffstahl Leg. Stahl ~30HRC		Quenched and tempered steel Vergüteter Stahl ~40HRC		Quenched and tempered steel Vergüteter Stahl ~45HRC		Quenched and tempered steel Vergüteter Stahl ~50HRC		Quenched and tempered steel Vergüteter Stahl ~55HRC	
	Diameter Ø Durchmesser (mm)	Rotating Drehzahl (min ⁻¹)	Feed Vorschub (mm/min)	Rotating Drehzahl (min ⁻¹)	Feed Vorschub (mm/min)	Rotating Drehzahl (min ⁻¹)	Feed Vorschub (mm/min)	Rotating Drehzahl (min ⁻¹)	Feed Vorschub (mm/min)	Rotating Drehzahl (min ⁻¹)
3.0×R0.8	21000	12500	21000	12000	16000	8400	16000	7850	10500	3300
4.0×R1.0	16000	13000	16000	12000	12000	9000	12000	8200	7950	3550
5.0×R1.2	12500	14000	12500	12500	9550	9550	9550	8600	6350	3800
6.0×R1.0 6.0×R1.5	10600	14000	10600	12700	7950	9550	7950	8600	5300	3800
8.0×R1.0 8.0×R2.0	7950	14000	7950	12700	5950	9550	5950	8600	4000	3800
10.0×R1.0 10.0×R2.0	6350	14000	6350	12700	4750	9550	4750	8600	3200	3800
12.0×R2.0 12.0×R3.0	5300	14000	5300	12700	4000	9550	4000	8600	2650	3800
Max. cutting depth max Schnitttiefe	max a _p =0.4mm						max a _p =0.2mm		max a _p =0.1mm	
	<p>The diagram illustrates a ball nose end mill cutting a workpiece. The axial cutting depth is labeled as $a_e = 0.3D$, where D is the diameter of the end mill. The radial cutting depth is labeled as $a_p = 0.2R$, where R is the radius of the end mill. The workpiece is shown with hatching to indicate the material being removed.</p>									

1. Please select high precise machine and tool holder.
2. Please use air blow or MQL (minimum oil mist cooling).
3. Down milling is recommended in side milling.
4. Vibration and unusual noise may be generated if the machine rigidity and workpiece fixture stability is low, please reduce the rotating speed and feed rate like mentioned above.
5. Make overhang as short as possible if no interference.
6. For overhang of $L/D \leq 4$ please use cutting condition from table above. For bigger overhang see table below.

1. Bitte präzise Maschinen und Werkzeughalter verwenden.
2. Als Kühlmittel bitte Luft oder MQL (Minimalmengen) verwenden.
3. Empfohlene Fräsmethode: Gleichlaufräsen.
4. Bei Vibrationen oder unüblichen Geräuschen reduzieren Sie die Schnittdaten (wie oben empfohlen) entsprechend.
5. Werkzeugauskrägung so kurz wie möglich wählen.
6. Für Auskräglängen $L/D \leq 4$ bitte die Parameter aus der Tabelle oben verwenden. Für $L/D > 4$ siehe Tabelle unten.

L/D	Vc(m/min)	a _e (mm)	f _n (mm/min)
L/D ≤ 4	100%	100%	100%
L/D = 5	60%~80%	60%~80%	60%~80%
L/D = 6	40%~60%	40%~60%	40%~60%

GM

Series end mills for general machining

Serie Eckfräser für allgemeine Anwendung

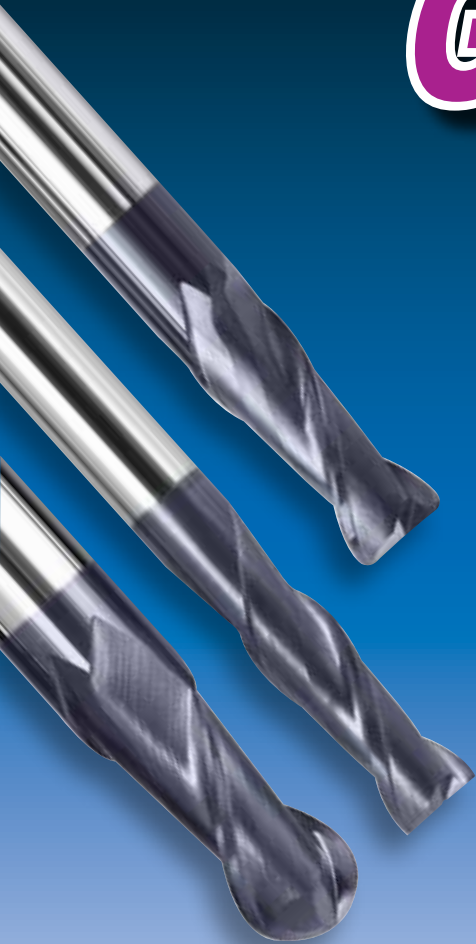

Wide application: high efficiency machining of common steel up to light hardend steel.

Optimized structure: reasonable combination of sharp cutting edge and tool strength makes cutting much light and fast, achieving longer tool-life.

Completess Programm (application): covers applications from roughing with high metal removal rate to finish machining with high surface quality.

Completess Programm (dimension): the minimum diameter of 0.3 mm, easily complete machining even though the micro part of workpiece.

Großer Anwendungsbereich: effiziente Bearbeitung von normalem bis zu leicht gehärtetem Stahl.

Optimiertes Design: Scharfe Schneide mit hoher Kantenstabilität. Für leichte und schnelle Bearbeitung mit hoher Standzeit.

komplettes Programm (Anwendung): vom Schruppen bei hoher Zerspanungsleistung bis Schlichten bei exzellenter Werkstückqualität.

komplettes Programm (Abmessung): ab Durchmesser 0,3 mm für die Bearbeitung von kleinen Werkstücken.

- Type / Typ : GM-4E-D10.0
- Size / Größe : Ø10.0mm
- Workpiece material / Werkstückstoff : NAK80 (40HRC)
- Rotating speed / Schnittgeschwindigkeit : 3200r/min (100m/min)
- Feed / Vorschub : 640mm/r (0.2mm/r)
- Axial cutting depth
Axiale Zustellung: $A_p=15\text{mm}$
- Radial cutting depth
Radiale Zustellung: $A_e=1.0\text{mm}$
- Cutting style / Bearbeitung : side milling / Eckfräsen
- Cooling system / Kühlsystem : air blow / Luft
- Machine / Maschine: MIKRON UCP 1000

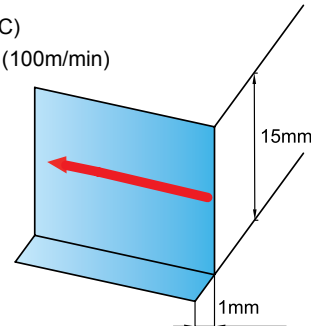

■ Cutting edge wear and surface quality of workpiece · Schneidkantenverschleiß und Werkstück Oberflächenqualität

End mills · Eckfräser	GM-4E-D10.0	Similar product of company A Ähnliches Produkt Firma A	Similar product of company B Ähnliches Produkt Firma B
Cutting length · Schnittlänge	60m	20m	60m

Cutting edge wear
Schneidkantenverschleiß



Workpiece surface quality
Werkstück Qualität



Milling · Fräsen

Solid Carbide end mills · Vollhartmetallschaftfräser

DIN 6527K 2-flute slotting end mills · **DIN 6527K** 2-Schneiden VHM Langlochfräser

5501R302GM

YK30F: Ultra-fine carbide grade / *Ultrafeinkornhartmetall*

KMG303: nano AlTiN Coated Ultra-fine Carbide / *nano AlTiN beschichtetes Ultrafeinkornhartmetall*

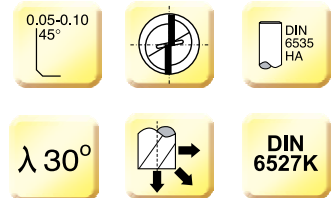
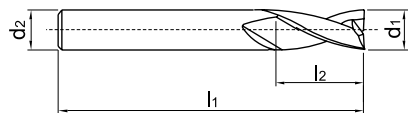
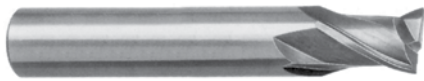

Type Typ	Dimension(mm) Abmessungen				Teeth Zähne	Application Anwendung	P M K	
	d1(e8)	d2(h6)	l2	l1			Grade Sorte	YK30F
5501R302GM-0300	3.00	6	4	50	2		○	●
5501R302GM-0400	4.00	6	5	54	2		○	●
5501R302GM-0500	5.00	6	6	54	2		○	●
5501R302GM-0600	6.00	6	7	54	2		○	●
5501R302GM-0800	8.00	8	9	58	2		○	●
5501R302GM-1000	10.00	10	11	66	2		○	●
5501R302GM-1200	12.00	12	12	73	2		○	●
5501R302GM-1400	14.00	14	14	75	2		○	●
5501R302GM-1600	16.00	16	16	82	2		○	●
5501R302GM-1800	18.00	18	18	84	2		○	●
5501R302GM-2000	20.00	20	20	92	2		○	●
Art. Group No. / Produktgruppe Nr. :							021140	021130

Material Overview · Material Übersicht

✓ = Very suitable · Sehr empfohlen
 ✓ = Suitable · Empfohlen

KMG303

Workpiece material Werkstückstoff											
Carbon steel Kohlenstoff Stahl	Alloy steel Legierter Stahl	Quenched and tempered steel · Vergüteter Stahl		Hardened steel · Gehärteter Stahl		Stainless steel · Rostfreier Stahl	Cast iron, Nodular cast iron Grauguss GGG	Copper alloy Kupfer Leg	Aluminum alloy Alu Leg	Titanium alloy Titan Leg	Heat resist alloy warmfeste Leg
		~40HRC	~50HRC	~60HRC	~68HRC						
✓	✓	✓	✓			✓	✓				

● Ex Stock / ab Lager ○ On demand / auf Anfrage

DIN 6527K 2-flute slotting end mills · DIN 6527K 2-Schneiden VHM Langlochfräser

5601R302GM

YK30F: Ultra-fine carbide grade / *Ultrafeinkornhartmetall*

KMG303: nano AlTiN Coated Ultra-fine Carbide / *nano AlTiN beschichtetes Ultrafeinkornhartmetall*

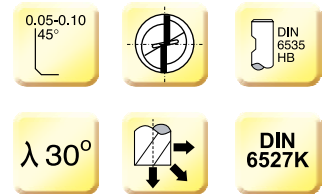
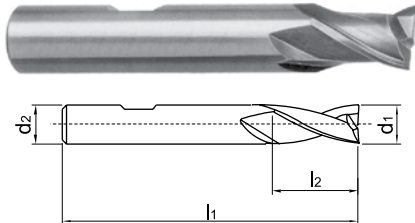

Type Typ	Dimension(mm) Abmessungen				Teeth Zähne	Application Anwendung	P M K	
	d1(e8)	d2(h6)	l2	l1			Grade Sorte	YK30F
5601R302GM-0300	3.00	6	4	50	2		○	●
5601R302GM-0400	4.00	6	5	54	2		○	●
5601R302GM-0500	5.00	6	6	54	2		○	●
5601R302GM-0600	6.00	6	7	54	2		○	●
5601R302GM-0800	8.00	8	9	58	2		○	●
5601R302GM-1000	10.00	10	11	66	2		○	●
5601R302GM-1200	12.00	12	12	73	2		○	●
5601R302GM-1400	14.00	14	14	75	2		○	●
5601R302GM-1600	16.00	16	16	82	2		○	●
5601R302GM-1800	18.00	18	18	84	2		○	●
5601R302GM-2000	20.00	20	20	92	2		○	●
Art. Group No. / Produktgruppe Nr. :							021140	021130

B

Solid Carbide end mills
Vollhartmetallschaftfräser

Material Overview · Material Übersicht

✓ = Very suitable · Sehr empfohlen
✓ = Suitable · Empfohlen

KMG303

Workpiece material Werkstückstoff											
Carbon steel Kohlenstoff Stahl	Alloy steel Legierter Stahl	Quenched and tempered steel · Vergüteter Stahl		Hardened steel · Gehärteter Stahl		Stainless steel · Rostfreier Stahl	Cast iron, Nodular cast iron Grauguss GGG	Copper alloy Kupfer Leg	Aluminum alloy Alu Leg	Titanium alloy Titan Leg	Heat resist alloy warmfeste Leg
		~40HRC	~50HRC	~60HRC	~68HRC						
✓	✓	✓	✓			✓	✓				

Code key B252,B254
ISO Kennzeichen

Cutting data B314-B321
Schnittdaten

Graphics identification & application B253-B255
Graphische Werkzeug- & Anwendungsbeschr.

Order form for non-standard products B534-B535
Bestellformular für Sonderwerkzeuge

Milling · Fräsen

Solid Carbide end mills · Vollhartmetallschaftfräser

DIN 6527L 2-flute slotting end mills · DIN 6527L 2-Schneiden VHM Langlochfräser

5502R302GM



YK30F: Ultra-fine carbide grade / Ultrafeinkornhartmetall

KMG303: nano AlTiN Coated Ultra-fine Carbide / nano AlTiN beschichtetes Ultrafeinkornhartmetall

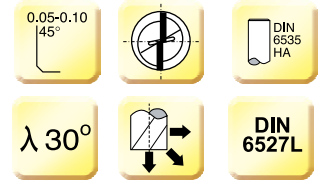
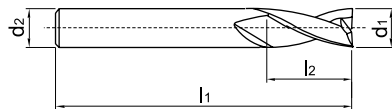

Type Typ	Dimension(mm) Abmessungen				Teeth Zähne	Application Anwendung	P M K	
	d1(e8)	d2(h6)	l2	l1			Grade Sorte	YK30F
5502R302GM-0100	1.00	3	2	38	2		○	●
5502R302GM-0150	1.50	3	3	38	2		○	●
5502R302GM-0200	2.00	6	6	57	2		○	●
5502R302GM-0250	2.50	6	7	57	2		○	●
5502R302GM-0280	2.80	6	7	57	2		○	●
5502R302GM-0300	3.00	6	7	57	2		○	●
5502R302GM-0350	3.50	6	7	57	2		○	●
5502R302GM-0380	3.80	6	8	57	2		○	●
5502R302GM-0400	4.00	6	8	57	2		○	●
5502R302GM-0450	4.50	6	8	57	2		○	●
5502R302GM-0480	4.80	6	8	57	2		○	●
5502R302GM-0500	5.00	6	10	57	2		○	●
5502R302GM-0550	5.50	6	10	57	2		○	●
5502R302GM-0575	5.75	6	10	57	2		○	●
5502R302GM-0600	6.00	6	10	57	2		○	●
5502R302GM-0675	6.75	8	13	63	2		○	○
5502R302GM-0700	7.00	8	13	63	2		○	●
5502R302GM-0750	7.50	8	16	63	2		○	●
5502R302GM-0775	7.75	8	16	63	2		○	●
5502R302GM-0800	8.00	8	16	63	2		○	●
5502R302GM-0870	8.70	10	16	72	2		○	●
5502R302GM-0900	9.00	10	16	72	2		○	●
5502R302GM-0950	9.50	10	16	72	2		○	○
5502R302GM-1000	10.00	10	19	72	2		○	●
5502R302GM-1100	11.00	12	22	83	2		○	●
5502R302GM-1170	11.70	12	22	83	2		○	●
5502R302GM-1200	12.00	12	22	83	2		○	●
5502R302GM-1370	13.70	14	22	83	2		○	●
5502R302GM-1400	14.00	14	22	83	2		○	●
5502R302GM-1500	15.00	16	26	92	2		○	●
5502R302GM-1570	15.70	16	26	92	2		○	●
5502R302GM-1600	16.00	16	26	92	2		○	●
5502R302GM-1700	17.00	18	26	92	2		○	○
5502R302GM-1800	18.00	18	26	92	2		○	●
5502R302GM-2000	20.00	20	32	104	2		○	●

Art. Group No. / Produktgruppe Nr. : 021140 021130

● Ex Stock / ab Lager ○ On demand / auf Anfrage

DIN 6527L 2-flute slotting end mills · DIN 6527L 2-Schneiden VHM Langlochfräser

5602R302GM

YK30F: Ultra-fine carbide grade / *Ultrafeinkornhartmetall*

KMG303: nano AlTiN Coated Ultra-fine Carbide / *nano AlTiN beschichtetes Ultrafeinkornhartmetall*

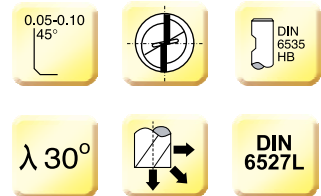
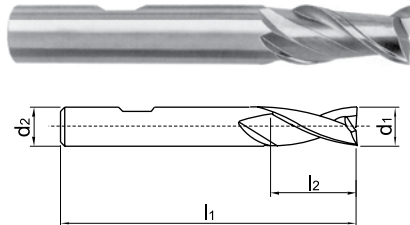

Type Typ	Dimension(mm) Abmessungen				Teeth Zähne	Application Anwendung	P M K	
	d1(e8)	d2(h6)	l2	l1			Grade Sorte	YK30F
5602R302GM-0200	2.00	6	6	57	2		○	●
5602R302GM-0250	2.50	6	7	57	2		○	●
5602R302GM-0280	2.80	6	7	57	2		○	●
5602R302GM-0300	3.00	6	7	57	2		○	●
5602R302GM-0350	3.50	6	7	57	2		○	●
5602R302GM-0380	3.80	6	8	57	2		○	●
5602R302GM-0400	4.00	6	8	57	2		○	●
5602R302GM-0450	4.50	6	8	57	2		○	●
5602R302GM-0480	4.80	6	8	57	2		○	●
5602R302GM-0500	5.00	6	10	57	2		○	●
5602R302GM-0550	5.50	6	10	57	2		○	●
5602R302GM-0575	5.75	6	10	57	2		○	●
5602R302GM-0600	6.00	6	10	57	2		○	●
5602R302GM-0675	6.75	8	13	63	2		○	○
5602R302GM-0700	7.00	8	13	63	2		○	●
5602R302GM-0750	7.50	8	16	63	2		○	●
5602R302GM-0775	7.75	8	16	63	2		○	●
5602R302GM-0800	8.00	8	16	63	2		○	●
5602R302GM-0870	8.70	10	16	72	2		○	●
5602R302GM-0900	9.00	10	16	72	2		○	●
5602R302GM-1000	10.00	10	19	72	2		○	●
5602R302GM-1170	11.70	12	22	83	2		○	●
5602R302GM-1200	12.00	12	22	83	2		○	●
5602R302GM-1370	13.70	14	22	83	2		○	●
5602R302GM-1400	14.00	14	22	83	2		○	●
5602R302GM-1570	15.70	16	26	92	2		○	●
5602R302GM-1600	16.00	16	26	92	2		○	●
5602R302GM-1800	18.00	18	26	92	2		○	●
5602R302GM-2000	20.00	20	32	104	2		○	●
Art. Group No. / Produktgruppe Nr. :							021140	021130

B

Solid Carbide end mills
Vollhartmetallschaftfräser

Milling · Fräsen

Solid Carbide end mills · Vollhartmetallschaftfräser

GM-2E

2-flute flattened end mills with straight shank
2-Schneiden Eckfräser mit Zylinderschaft

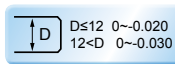
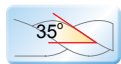
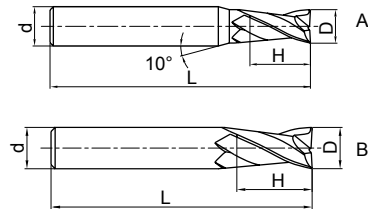
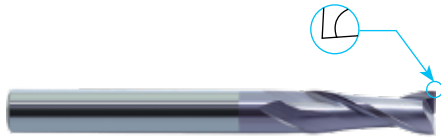

Type Typ	Dimension (mm) Abmessungen				Teeth Zähne Z	Geometry Ausführung	Grade Sorte KMG 303
	D	d	H	L			
GM-2E-D1.0S	1.0	4	3	50	2	A	●
GM-2E-D1.5S	1.5	4	4	50	2	A	●
GM-2E-D2.0S	2.0	4	6	50	2	A	●
GM-2E-D2.5S	2.5	4	8	50	2	A	●
GM-2E-D3.0S	3.0	4	8	50	2	A	●
GM-2E-D4.0S	4.0	4	11	50	2	B	●
GM-2E-D1.0	1.0	6	3	50	2	A	●
GM-2E-D1.5	1.5	6	4	50	2	A	●
GM-2E-D2.0	2.0	6	6	50	2	A	●
GM-2E-D2.5	2.5	6	8	50	2	A	●
GM-2E-D3.0	3.0	6	8	50	2	A	●
GM-2E-D3.5	3.5	6	10	50	2	A	●
GM-2E-D4.0	4.0	6	11	50	2	A	●
GM-2E-D4.5	4.5	6	11	50	2	A	●
GM-2E-D5.0	5.0	6	13	50	2	A	●
GM-2E-D5.5	5.5	6	16	50	2	A	●
GM-2E-D6.0	6.0	6	16	50	2	B	●
GM-2E-D7.0	7.0	8	20	60	2	A	●
GM-2E-D8.0	8.0	8	20	60	2	B	●
GM-2E-D9.0	9.0	10	22	75	2	A	●
GM-2E-D10.0	10.0	10	25	75	2	B	●
GM-2E-D11.0	11.0	12	26	75	2	A	●
GM-2E-D12.0	12.0	12	30	75	2	B	●
GM-2E-D14.0	14.0	14	32	75	2	B	●
GM-2E-D16.0	16.0	16	45	100	2	B	●
GM-2E-D18.0	18.0	18	45	100	2	B	●
GM-2E-D20.0	20.0	20	45	100	2	B	●

Material Overview · Material Übersicht

✓ = Very suitable · Sehr empfohlen
✓ = Suitable · Empfohlen

KMG303

		Workpiece material Werkstückstoff									
Carbon steel Kohlenstoff Stahl	Alloy steel Legierter Stahl	Quenched and tempered steel · Vergüteter Stahl		Hardened steel · Gehärteter Stahl		Stainless steel · Rostfreier Stahl	Cast iron, Nodular cast iron Grauguss GGG	Copper alloy Kupfer Leg	Aluminum alloy Alu Leg	Titanium alloy Titan Leg	Heat resist alloy warmfeste Leg
		~40HRC	~50HRC	~55HRC	~68HRC						
✓	✓	✓	✓			✓	✓				

● Ex Stock / ab Lager ○ On demand / auf Anfrage

GM-2EL series for general machining · GM-2EL Serie für allgemeine Bearbeitung

2-flute flattened end mills with straight shank and long cutting edge
2-Schneiden Eckfräser mit langer Schneide und Zylinderschaft

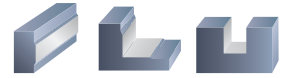



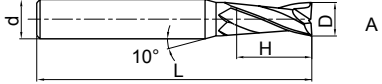

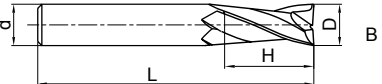

A

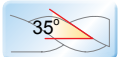

B



35°



Coated
TiAlN

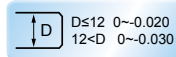

D ≤ 12 0 ~ -0.020
12 < D 0 ~ -0.030



Type Typ	Dimension (mm) Abmessungen				Teeth Zähne Z	Geometry Ausführung	Grade Sorte KMG 303
	D	d	H	L			
GM-2EL-D3.0	3.0	6	12	75	2	A	●
GM-2EL-D4.0	4.0	6	15	75	2	A	●
GM-2EL-D5.0	5.0	6	20	75	2	A	●
GM-2EL-D6.0	6.0	6	20	75	2	B	●
GM-2EL-D8.0	8.0	8	25	100	2	B	●
GM-2EL-D10.0	10.0	10	30	100	2	B	●
GM-2EL-D12.0	12.0	12	35	100	2	B	●
GM-2EL-D14.0	14.0	14	40	100	2	B	●
GM-2EL-D16.0	16.0	16	50	150	2	B	●
GM-2EL-D20.0	20.0	20	55	150	2	B	●

B

Solid Carbide end mills
Vollhartmetallschaftfräser

Material Overview · Material Übersicht

✓ = Very suitable · Sehr empfohlen
✓ = Suitable · Empfohlen

KMG303

Workpiece material Werkstückstoff											
Carbon steel Kohlenstoff Stahl	Alloy steel Legierter Stahl	Quenched and tempered steel · Vergüteter Stahl		Hardened steel · Gehärteter Stahl		Stainless steel · Rostfreier Stahl	Cast iron, Nodular cast iron Grauguss GGG	Copper alloy Kupfer Leg	Aluminum alloy Alu Leg	Titanium alloy Titan Leg	Heat resist alloy warmfeste Leg
		~40HRC	~50HRC	~55HRC	~68HRC						
✓	✓	✓	✓			✓	✓				

Code key **B252, B254**
ISO Kennzeichen

Cutting data **B314-B321**
Schnittdaten

Graphics identification & application **B253-B255**
Graphische Werkzeug- & Anwendungsbeschr.

Order form for non-standard products **B534-B535**
Bestellformular für Sonderwerkzeuge

Milling · Fräsen

Solid Carbide end mills · Vollhartmetallschaftfräser

GM-2EX

2-flute flattened end mills with straight shank and very long cutting edge
2-Schneiden Eckfräser mit extra langer Schneide und Zylinderschaft

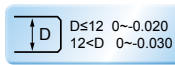
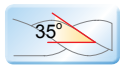
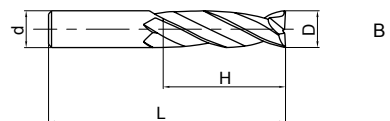
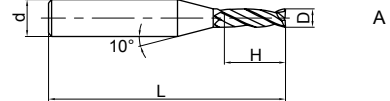

Type Typ	Dimension (mm) Abmessungen				Teeth Zähne Z	Geometry Ausführung	Grade Sorte KMG 303
	D	d	H	L			
GM-2EX-D3.0	3.0	6	20	75	2	A	●
GM-2EX-D4.0	4.0	6	25	75	2	A	●
GM-2EX-D5.0	5.0	6	30	75	2	A	●
GM-2EX-D6.0	6.0	6	30	75	2	B	●
GM-2EX-D8.0	8.0	8	40	100	2	B	●
GM-2EX-D10.0	10.0	10	50	110	2	B	●
GM-2EX-D12.0	12.0	12	50	110	2	B	●
GM-2EX-D16.0	16.0	16	70	150	2	B	●
GM-2EX-D20.0	20.0	20	75	150	2	B	●

B

Solid Carbide end mills
Vollhartmetallschaftfräser

Material Overview · Material Übersicht

✓ = Very suitable · Sehr empfohlen
✓ = Suitable · Empfohlen

KMG303

Workpiece material Werkstückstoff											
Carbon steel Kohlenstoff Stahl	Alloy steel Legierter Stahl	Quenched and tempered steel · Vergüteter Stahl		Hardened steel · Gehärteter Stahl		Stainless steel · Rostfreier Stahl	Cast iron, Nodular cast iron Grauguss GGG	Copper alloy Kupfer Leg	Aluminum alloy Alu Leg	Titanium alloy Titan Leg	Heat resist alloy warmfeste Leg
		~40HRC	~50HRC	~55HRC	~68HRC						
✓	✓	✓	✓			✓	✓				

● Ex Stock / ab Lager ○ On demand / auf Anfrage

GM-2EFP

2-flute end mills with straight shank and short cutting edge and long neck
 2-Schneiden Eckfräser mit kurzer Schneide und Zylinderschaft

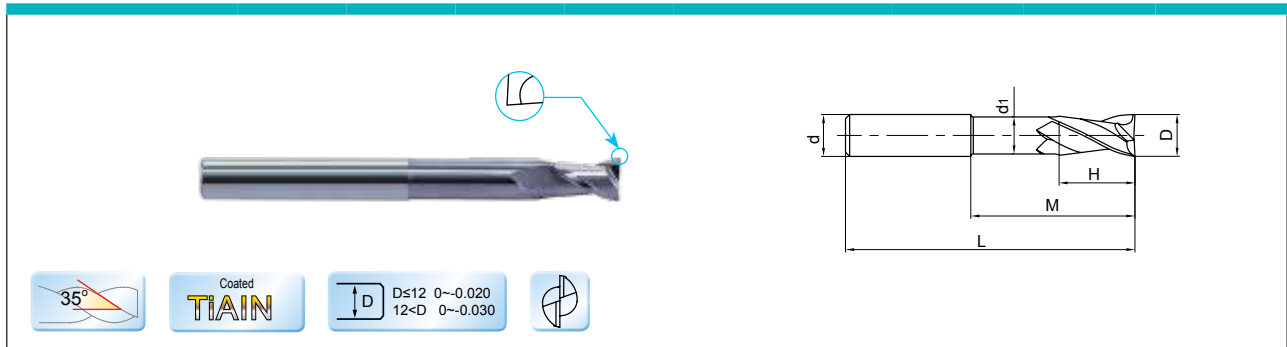

Type Typ	Dimension(mm) Abmessungen						Geometry Ausführung	Teeth · Zähne Z	Grade Sorte KMG 303
	D	d	H	M	d ₁	L			
GM-2EFP-D6.0	6.0	6	9	9	5.8	30	75	2	•
GM-2EFP-D8.0	8.0	8	12	12	7.8	40	100	2	•
GM-2EFP-D10.0	10.0	10	15	15	9.6	50	100	2	•
GM-2EFP-D12.0	12.0	12	18	18	11.5	50	100	2	•
GM-2EFP-D16.0	16.0	16	24	24	15.5	50	150	2	•

B

Solid Carbide end mills
 Vollhartmetallschaftfräser

Material Overview · Material Übersicht

✓ = Very suitable · Sehr empfohlen
 ✓ = Suitable · Empfohlen

KMG303

Workpiece material Werkstückstoff											
Carbon steel Kohlenstoff Stahl	Alloy steel Legierter Stahl	Quenched and tempered steel · Vergüteter Stahl		Hardened steel · Gehärteter Stahl		Stainless steel · Rostfreier Stahl	Cast iron, Nodular cast iron Grauguss GGG	Copper alloy Kupfer Leg	Aluminum alloy Alu Leg	Titanium alloy Titan Leg	Heat resist alloy warmfeste Leg
		~40HRC	~50HRC	~55HRC	~68HRC						
✓	✓	✓	✓			✓	✓				

Code key B252,B254
 ISO Kennzeichen

Cutting data B314-B321
 Schnittdaten

Graphics identification & application B253-B255
 Graphische Werkzeug- & Anwendungsbeschr.

Order form for non-standard products B534-B535
 Bestellformular für Sonderwerkzeuge

Milling · Fräsen

Solid Carbide end mills · Vollhartmetallschaftfräser

GM-2F

2-flute flattened end mills with straight shank
2-Schneiden Eckfräser mit Zylinderschaft

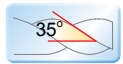
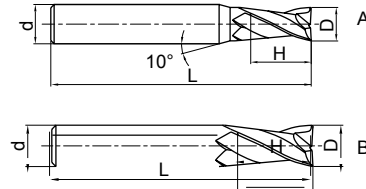
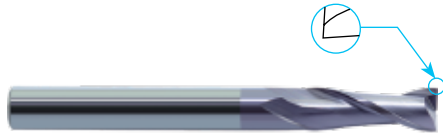

Type Typ	Dimension (mm) Abmessungen				Teeth Zähne Z	Geometry Ausführung	Grade Sorte KMG 303
	D	d	H	L			
GM-2F-D1.0S	1.0	4	3	50	2	A	○
GM-2F-D1.5S	1.5	4	4	50	2	A	○
GM-2F-D2.0S	2.0	4	6	50	2	A	○
GM-2F-D2.5S	2.5	4	8	50	2	A	○
GM-2F-D3.0S	3.0	4	8	50	2	A	○
GM-2F-D4.0S	4.0	4	11	50	2	B	○
GM-2F-D1.0	1.0	6	3	50	2	A	○
GM-2F-D1.5	1.5	6	4	50	2	A	○
GM-2F-D2.0	2.0	6	6	50	2	A	○
GM-2F-D2.5	2.5	6	8	50	2	A	○
GM-2F-D3.0	3.0	6	8	50	2	A	●
GM-2F-D3.5	3.5	6	10	50	2	A	●
GM-2F-D4.0	4.0	6	11	50	2	A	●
GM-2F-D4.5	4.5	6	11	50	2	A	○
GM-2F-D5.0	5.0	6	13	50	2	A	●
GM-2F-D5.5	5.5	6	16	50	2	A	○
GM-2F-D6.0	6.0	6	16	50	2	B	●
GM-2F-D7.0	7.0	8	20	60	2	A	○
GM-2F-D8.0	8.0	8	20	60	2	B	●
GM-2F-D9.0	9.0	10	22	75	2	A	○
GM-2F-D10.0	10.0	10	25	75	2	B	●
GM-2F-D11.0	11.0	12	26	75	2	A	○
GM-2F-D12.0	12.0	12	30	75	2	B	●
GM-2F-D14.0	14.0	14	32	75	2	B	○
GM-2F-D16.0	16.0	16	45	100	2	B	○
GM-2F-D18.0	18.0	18	45	100	2	B	○
GM-2F-D20.0	20.0	20	45	100	2	B	○

Material Overview · Material Übersicht

✓ = Very suitable · Sehr empfohlen
✓ = Suitable · Empfohlen

KMG303

		Workpiece material Werkstückstoff									
Carbon steel Kohlenstoff Stahl	Alloy steel Legierter Stahl	Quenched and tempered steel · Vergüteter Stahl		Hardened steel · Gehärteter Stahl		Stainless steel · Rostfreier Stahl	Cast iron, Nodular cast iron Grauguss GGG	Copper alloy Kupfer Leg	Aluminum alloy Alu Leg	Titanium alloy Titan Leg	Heat resist alloy warmfeste Leg
		~40HRC	~50HRC	~55HRC	~68HRC						
✓	✓	✓	✓			✓	✓				

● Ex Stock / ab Lager ○ On demand / auf Anfrage

GM-2FL

2-flute end mills with straight shank and long cutting edge and long neck
2-Schneiden Eckfräser mit langer Schneide und Zylinderschaft

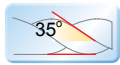
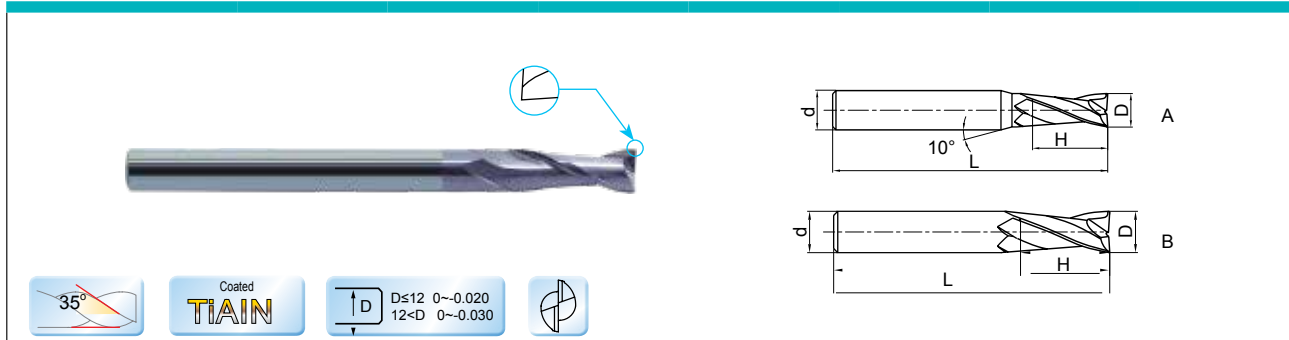

Type Typ	Dimension(mm) Abmessungen				Teeth Zähne Z	Geometry Ausführung	Grade Sorte KMG 303
	D	d	H	L			
GM-2FL-D3.0	3.0	6	12	75	2	A	●
GM-2FL-D4.0	4.0	6	15	75	2	A	●
GM-2FL-D5.0	5.0	6	20	75	2	A	○
GM-2FL-D6.0	6.0	6	20	75	2	B	●
GM-2FL-D8.0	8.0	8	25	100	2	B	○
GM-2FL-D10.0	10.0	10	30	100	2	B	○
GM-2FL-D12.0	12.0	12	35	100	2	B	○
GM-2FL-D14.0	14.0	14	40	100	2	B	○
GM-2FL-D16.0	16.0	16	50	150	2	B	○
GM-2FL-D20.0	20.0	20	55	150	2	B	○

B

Solid Carbide end mills
Vollhartmetallschaftfräser

Material Overview · Material Übersicht

✓ = Very suitable · Sehr empfohlen
✓ = Suitable · Empfohlen

KMG303

Workpiece material Werkstückstoff											
Carbon steel Kohlenstoff Stahl	Alloy steel Legierter Stahl	Quenched and tempered steel · Vergüteter Stahl		Hardened steel · Gehärteter Stahl		Stainless steel · Rostfreier Stahl	Cast iron, Nodular cast iron Grauguss GGG	Copper alloy Kupfer Leg	Aluminum alloy Alu Leg	Titanium alloy Titan Leg	Heat resist alloy warmfeste Leg
		~40HRC	~50HRC	~55HRC	~68HRC						
✓	✓	✓	✓			✓	✓				

Code key B252,B254
ISO Kennzeichen

Cutting data B314-B321
Schnittdaten



Graphics identification & application B253-B255
Graphische Werkzeug- & Anwendungsbeschr.

Order form for non-standard products B534-B535
Bestellformular für Sonderwerkzeuge

Milling - Fräsen

Solid Carbide end mills - Vollhartmetallschaftfräser

Recommended cutting data - Empfohlene Schnittdaten

Type Typ	Grade Sorte	Material Werkstoffe	d ₁ (mm)	z	V _c (m/min)	f _z (mm/z)	a _p (mm)	a _e (mm)	n (min ⁻¹)	V _f (mm/min)	
5501R302GM  	YK30F	K Cast iron Guss	3.00	2	60	0.010	1.50	3.00	6360	127	
			4.00	2	60	0.015	2.00	4.00	4770	143	
			5.00	2	60	0.020	2.50	5.00	3810	152	
			6.00	2	60	0.024	3.00	6.00	3180	153	
			8.00	2	60	0.032	4.00	8.00	2380	152	
			10.00	2	60	0.038	5.00	10.00	1900	144	
			12.00	2	60	0.046	6.00	12.00	1590	146	
			16.00	2	60	0.054	8.00	16.00	1190	129	
			20.00	2	60	0.066	10.00	20.00	950	125	
		N Aluminum alloy Alu-Legierung Si<=10%	3.00	2	220	0.010	1.50	3.00	23340	467	
			4.00	2	220	0.015	2.00	4.00	17500	525	
			5.00	2	220	0.020	2.50	5.00	14000	560	
			6.00	2	220	0.024	3.00	6.00	11670	560	
			8.00	2	220	0.032	4.00	8.00	8750	560	
			10.00	2	220	0.038	5.00	10.00	7000	532	
			12.00	2	220	0.046	6.00	12.00	5830	536	
			16.00	2	220	0.054	8.00	16.00	4370	472	
			20.00	2	220	0.066	10.00	20.00	3500	462	
			Brass Bronze Kupfer	3.00	2	90	0.010	1.50	3.00	9540	191
				4.00	2	90	0.015	2.00	4.00	7160	215
				5.00	2	90	0.020	2.50	5.00	5720	229
				6.00	2	90	0.024	3.00	6.00	4770	229
				8.00	2	90	0.032	4.00	8.00	3580	229
				10.00	2	90	0.038	5.00	10.00	2860	217
				12.00	2	90	0.046	6.00	12.00	2380	219
				16.00	2	90	0.054	8.00	16.00	1790	193
				20.00	2	90	0.066	10.00	20.00	1430	189

- Please start a test cutting with 85% of the V_c or 75% of the f_z, then increase the cutting speed and feed rate.
- Please use high precision and high rigidity clamping system. The oscillation of the tool can not be over 0.01 mm.
- When a_p=1*d₁, f_z = 75% as the data in the table.

- Bitte führen Sie einen Testschnitt mit 85% der V_c und 75% des f_z durch.
Nach erfolgtem Test können Sie die Schnittgeschwindigkeit bzw. die Vorschubwerte entsprechend erhöhen.
- Bitte verwenden Sie nur Spannmittel mit einer hohen Genauigkeit und einer hohen Spannkraft.
Überprüfen Sie den Rundlauf der Werkzeuge. Sie sollten darauf achten, dass der Rundlauffehler nicht größer als 0.01 mm ist.
- Bei Fräsoperationen, die mit einer a_p=1*d₁ durchgeführt werden, ist f_z um 25% zu reduzieren.

B

Solid Carbide end mills
Vollhartmetallschaftfräser

Recommended cutting data · Empfohlene Schnittdaten

Type Typ	Grade Sorte	Material Werkstoffe	d ₁ (mm)	z	V _c (m/min)	f _z (mm/z)	a _p (mm)	a _e (mm)	n (min ⁻¹)	V _f (mm/min)
5501R302GM	KMG303	Steel Stahl HRC<25	3.00	2	105	0.010	1.50	3.00	11140	223
5601R302GM	KMG303		4.00	2	105	0.015	2.00	4.00	8350	251
			5.00	2	105	0.020	2.50	5.00	6680	267
			6.00	2	105	0.024	3.00	6.00	5570	267
			8.00	2	105	0.032	4.00	8.00	4170	267
			10.00	2	105	0.038	5.00	10.00	3340	254
			12.00	2	105	0.046	6.00	12.00	2780	256
			16.00	2	105	0.054	8.00	16.00	2080	225
			20.00	2	105	0.066	10.00	20.00	1670	220
			3.00	2	75	0.010	1.50	3.00	7950	159
			4.00	2	75	0.015	2.00	4.00	5960	179
			5.00	2	75	0.020	2.50	5.00	4770	191
			6.00	2	75	0.024	3.00	6.00	3970	191
			8.00	2	75	0.032	4.00	8.00	2980	191
			10.00	2	75	0.038	5.00	10.00	2380	181
			12.00	2	75	0.046	6.00	12.00	1980	182
		16.00	2	75	0.054	8.00	16.00	1490	161	
		20.00	2	75	0.066	10.00	20.00	1190	157	
		3.00	2	40	0.010	1.50	3.00	4240	85	
		4.00	2	40	0.010	2.00	4.00	3180	64	
		5.00	2	40	0.014	2.50	5.00	2540	71	
		6.00	2	40	0.017	3.00	6.00	2120	72	
		8.00	2	40	0.024	4.00	8.00	1590	76	
		10.00	2	40	0.030	5.00	10.00	1270	76	
		12.00	2	40	0.036	6.00	12.00	1060	76	
		16.00	2	40	0.045	8.00	16.00	790	71	
		20.00	2	40	0.057	10.00	20.00	630	72	
		3.00	2	120	0.010	1.50	3.00	12730	255	
		4.00	2	120	0.015	2.00	4.00	9540	286	
		5.00	2	120	0.020	2.50	5.00	7630	305	
		6.00	2	120	0.024	3.00	6.00	6360	305	
		8.00	2	120	0.032	4.00	8.00	4770	305	
		10.00	2	120	0.038	5.00	10.00	3810	290	
		12.00	2	120	0.046	6.00	12.00	3180	293	
		16.00	2	120	0.054	8.00	16.00	2380	257	
		20.00	2	120	0.066	10.00	20.00	1900	251	
		3.00	2	220	0.010	1.50	3.00	23340	467	
		4.00	2	220	0.015	2.00	4.00	17500	525	
		5.00	2	220	0.020	2.50	5.00	14000	560	
		6.00	2	220	0.024	3.00	6.00	11670	560	
		8.00	2	220	0.032	4.00	8.00	8750	560	
		10.00	2	220	0.038	5.00	10.00	7000	532	
		12.00	2	220	0.046	6.00	12.00	5830	536	
		16.00	2	220	0.054	8.00	16.00	4370	472	
		20.00	2	220	0.066	10.00	20.00	3500	462	
		3.00	2	90	0.010	1.50	3.00	9540	191	
		4.00	2	90	0.015	2.00	4.00	7160	215	
		5.00	2	90	0.020	2.50	5.00	5720	229	
		6.00	2	90	0.024	3.00	6.00	4770	229	
		8.00	2	90	0.032	4.00	8.00	3580	229	
		10.00	2	90	0.038	5.00	10.00	2860	217	
		12.00	2	90	0.046	6.00	12.00	2380	219	
		16.00	2	90	0.054	8.00	16.00	1790	193	
		20.00	2	90	0.066	10.00	20.00	1430	189	

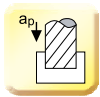

- Please start a test cutting with 85% of the V_c or 75% of the f_z, then increase the cutting speed and feed rate.

- Please use high precision and high rigidity clamping system. The oscillation of the tool can not be over 0.01 mm.

- When a_p=1*d₁, f_z = 75% as the data in the table.

- Bitte führen Sie einen Testschnitt mit 85% der V_c und 75% des f_z durch. Nach erfolgreichem Test können Sie die Schnittgeschwindigkeit bzw. die Vorschubwerte entsprechend erhöhen.



- Bitte verwenden Sie nur Spannmittel mit einer hohen Genauigkeit und einer hohen Spannkraft. Überprüfen Sie den Rundlauf der Werkzeuge. Sie sollten darauf achten, dass der Rundlauffehler nicht größer als 0.01 mm ist.

- Bei Fräsoperationen, die mit einer a_p=1*d₁ durchgeführt werden, ist f_z um 25% zu reduzieren.

Milling - Fräsen

Solid Carbide end mills - Vollhartmetallschaftfräser

Recommended cutting data - Empfohlene Schnittdaten

Type Typ	Grade Sorte	Material Werkstoffe	d1 (mm)	z	Vc (m/min)	fz (mm/z)	ap (mm)	ae (mm)	n (min ⁻¹)	Vf (mm/min)	
 	YK30F	K Cast iron Guss	3.00	2	60	0.010	1.50	3.00	6360	127	
			4.00	2	60	0.015	2.00	4.00	4770	143	
			5.00	2	60	0.020	2.50	5.00	3810	152	
			6.00	2	60	0.024	3.00	6.00	3180	153	
			8.00	2	60	0.032	4.00	8.00	2380	152	
			10.00	2	60	0.038	5.00	10.00	1900	144	
			12.00	2	60	0.046	6.00	12.00	1590	146	
			16.00	2	60	0.054	8.00	16.00	1190	129	
			20.00	2	60	0.066	10.00	20.00	950	125	
		N	Aluminum alloy Alu-Legierung Si<=10%	3.00	2	220	0.010	1.50	3.00	23340	467
				4.00	2	220	0.015	2.00	4.00	17500	525
				5.00	2	220	0.020	2.50	5.00	14000	560
				6.00	2	220	0.024	3.00	6.00	11670	560
				8.00	2	220	0.032	4.00	8.00	8750	560
				10.00	2	220	0.038	5.00	10.00	7000	532
				12.00	2	220	0.046	6.00	12.00	5830	536
				16.00	2	220	0.054	8.00	16.00	4370	472
				20.00	2	220	0.066	10.00	20.00	3500	462
			Brass Bronze Kupfer	3.00	2	90	0.010	1.50	3.00	9540	191
				4.00	2	90	0.015	2.00	4.00	7160	215
				5.00	2	90	0.020	2.50	5.00	5720	229
				6.00	2	90	0.024	3.00	6.00	4770	229
				8.00	2	90	0.032	4.00	8.00	3580	229
				10.00	2	90	0.038	5.00	10.00	2860	217
				12.00	2	90	0.046	6.00	12.00	2380	219
				16.00	2	90	0.054	8.00	16.00	1790	193
				20.00	2	90	0.066	10.00	20.00	1430	189

- Please start a test cutting with 85% of the Vc or 75% of the fz, then increase the cutting speed and feed rate.
- Please use high precision and high rigidity clamping system. The oscillation of the tool can not be over 0.01 mm.
- When $ap=1*d1$, $fz = 75%$ as the data in the table.

- Bitte führen Sie einen Testschnitt mit 85% der Vc und 75% des fz durch.
Nach erfolgtem Test können Sie die Schnittgeschwindigkeit bzw. die Vorschubwerte entsprechend erhöhen.
- Bitte verwenden Sie nur Spannmittel mit einer hohen Genauigkeit und einer hohen Spannkraft.
Überprüfen Sie den Rundlauf der Werkzeuge. Sie sollten darauf achten, dass der Rundlauffehler nicht größer als 0.01 mm ist.
- Bei Fräsoperationen, die mit einer $ap=1*d1$ durchgeführt werden, ist fz um 25% zu reduzieren.

B

Solid Carbide end mills
Vollhartmetallschaftfräser

Recommended cutting data · Empfohlene Schnittdaten

Type Typ	Grade Sorte	Material Werkstoffe	d ₁ (mm)	z	V _c (m/min)	f _z (mm/z)	a _p (mm)	a _e (mm)	n (min ⁻¹)	V _f (mm/min)
5502R302GM	KMG303	Steel Stahl HRC<25	3.00	2	95	0.010	1.50	3.00	10070	201
5602R302GM	KMG303		4.00	2	95	0.015	2.00	4.00	7550	227
			5.00	2	95	0.020	2.50	5.00	6040	242
			6.00	2	95	0.024	3.00	6.00	5030	241
			8.00	2	95	0.032	4.00	8.00	3770	241
			10.00	2	95	0.038	5.00	10.00	3020	230
			12.00	2	95	0.046	6.00	12.00	2510	231
			16.00	2	95	0.054	8.00	16.00	1880	203
		20.00	2	95	0.066	10.00	20.00	1510	199	
		Steel, Steel alloy Stahl, legierter Stahl HRC=25-38	3.00	2	70	0.010	1.50	3.00	7420	148
			4.00	2	70	0.015	2.00	4.00	5570	167
			5.00	2	70	0.020	2.50	5.00	4450	178
			6.00	2	70	0.024	3.00	6.00	3710	178
			8.00	2	70	0.032	4.00	8.00	2780	178
			10.00	2	70	0.038	5.00	10.00	2220	169
			12.00	2	70	0.046	6.00	12.00	1850	170
			16.00	2	70	0.054	8.00	16.00	1390	150
		20.00	2	70	0.066	10.00	20.00	1110	147	
		High ally steel Hochlegierter Stahl	3.00	2	40	0.010	1.50	3.00	4240	85
			4.00	2	40	0.010	2.00	4.00	3180	64
			5.00	2	40	0.014	2.50	5.00	2540	71
		Stainless steel Rostfreier Stahl	6.00	2	40	0.017	3.00	6.00	2120	72
			8.00	2	40	0.024	4.00	8.00	1590	76
			10.00	2	40	0.030	5.00	10.00	1270	76
		Ti and Ti alloys Ti-Legierungen	12.00	2	40	0.036	6.00	12.00	1060	76
			16.00	2	40	0.045	8.00	16.00	790	71
			20.00	2	40	0.057	10.00	20.00	630	72
		Cast iron Guss	3.00	2	100	0.010	1.50	3.00	10610	212
			4.00	2	100	0.015	2.00	4.00	7950	239
			5.00	2	100	0.020	2.50	5.00	6360	254
			6.00	2	100	0.024	3.00	6.00	5300	254
			8.00	2	100	0.032	4.00	8.00	3970	254
			10.00	2	100	0.038	5.00	10.00	3180	242
			12.00	2	100	0.046	6.00	12.00	2650	244
			16.00	2	100	0.054	8.00	16.00	1980	214
		20.00	2	100	0.066	10.00	20.00	1590	210	
		Aluminum alloy Alu-Legierung Si<=10%	3.00	2	220	0.010	1.50	3.00	23340	467
			4.00	2	220	0.015	2.00	4.00	17500	525
			5.00	2	220	0.020	2.50	5.00	14000	560
			6.00	2	220	0.024	3.00	6.00	11670	560
			8.00	2	220	0.032	4.00	8.00	8750	560
			10.00	2	220	0.038	5.00	10.00	7000	532
			12.00	2	220	0.046	6.00	12.00	5830	536
			16.00	2	220	0.054	8.00	16.00	4370	472
			20.00	2	220	0.066	10.00	20.00	3500	462
			Brass Bronze Kupfer	3.00	2	90	0.010	1.50	3.00	9540
		4.00		2	90	0.015	2.00	4.00	7160	215
		5.00		2	90	0.020	2.50	5.00	5720	229
		6.00		2	90	0.024	3.00	6.00	4770	229
		8.00		2	90	0.032	4.00	8.00	3580	229
		10.00		2	90	0.038	5.00	10.00	2860	217
		12.00		2	90	0.046	6.00	12.00	2380	219
		16.00		2	90	0.054	8.00	16.00	1790	193
		20.00	2	90	0.066	10.00	20.00	1430	189	

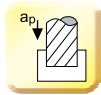

- Please start a test cutting with 85% of the V_c or 75% of the f_z, then increase the cutting speed and feed rate.
- Please use high precision and high rigidity clamping system. The oscillation of the tool can not be over 0.01 mm.
- When a_p=1*d₁, f_z = 75% as the data in the table.
- Bitte führen Sie einen Testschnitt mit 85% der V_c und 75% des f_z durch. Nach erfolgreichem Test können Sie die Schnittgeschwindigkeit bzw. die Vorschubwerte entsprechend erhöhen.
- Bitte verwenden Sie nur Spannmittel mit einer hohen Genauigkeit und einer hohen Spannkraft. Überprüfen Sie den Rundlauf der Werkzeuge. Sie sollten darauf achten, dass der Rundlauffehler nicht größer als 0.01 mm ist.
- Bei Fräsoperationen, die mit einer a_p=1*d₁ durchgeführt werden, ist f_z um 25% zu reduzieren.

Milling - Fräsen

Solid Carbide end mills - Vollhartmetallschaftfräser

Recommended cutting data - Empfohlene Schnittdaten

GM-2E | GM-2EL

Workpiece material Werkstückmaterial	Cast iron, Nodular cast iron Grauguss GGG		Carbon steel, Alloy steel Kohlenstoffstahl Leg. Stahl ~750N/mm ²		Carbon steel, Alloy steel Kohlenstoffstahl Leg. Stahl ~30HRC		Pre-hardened steel, Quenched and tempered steel Vergüteter Stahl ~40HRC		Stainless steel Rostfreier Stahl		Pre-hardened steel, Quenched and tempered steel Vergüteter Stahl ~50HRC	
	Diameter Ø Durchmesser (mm)	Rotating Drehzahl (min ⁻¹)	Feed Vorschub (mm/min)	Rotating Drehzahl (min ⁻¹)	Feed Vorschub (mm/min)	Rotating Drehzahl (min ⁻¹)	Feed Vorschub (mm/min)	Rotating Drehzahl (min ⁻¹)	Feed Vorschub (mm/min)	Rotating Drehzahl (min ⁻¹)	Feed Vorschub (mm/min)	Rotating Drehzahl (min ⁻¹)
1	20000	165	20000	165	20000	135	20000	135	20000	50	20000	100
2	15000	265	15000	265	15000	240	15000	235	11150	70	13000	150
3	14000	455	14000	455	13000	420	10600	350	7500	100	8500	275
4	10800	465	10800	465	10000	430	8000	355	5500	110	6500	280
5	8200	485	8200	485	7600	450	6400	370	4500	110	5000	295
6	7000	500	7000	500	6400	460	5300	385	3700	115	4200	300
8	5200	495	5200	495	4800	455	4000	380	2800	115	3200	305
10	4200	485	4200	485	3800	450	3200	370	2200	115	2500	290
12	3500	485	3500	485	3200	450	2650	370	1850	115	2100	290
14	3000	455	3000	455	2700	420	2300	350	1600	110	1800	275
16	2600	455	2600	455	2400	420	2000	350	1400	100	1600	275
18	2300	445	2300	445	2100	410	1800	345	1250	100	1400	270
20	2050	445	2050	445	1900	410	1600	345	1100	100	1250	270

Max. cutting depth max Schnitttiefe									
	<table border="1"> <thead> <tr> <th colspan="2">Milling slot · Nutenfräsen</th> </tr> <tr> <th>Ø</th> <th>Ap</th> </tr> </thead> <tbody> <tr> <td>Ø1 ≤ D < Ø3</td> <td>0.15D</td> </tr> <tr> <td>Ø3 ≤ D</td> <td>0.3D</td> </tr> </tbody> </table>	Milling slot · Nutenfräsen		Ø	Ap	Ø1 ≤ D < Ø3	0.15D	Ø3 ≤ D	0.3D
Milling slot · Nutenfräsen									
Ø	Ap								
Ø1 ≤ D < Ø3	0.15D								
Ø3 ≤ D	0.3D								

- The above table shows the standard value of side milling. When slot milling, of rotating speed 50%~70% and feed rate like mentioned above 40%~60%.
- Please select high precise machine and tool holder.
- Please use air blow or cutting liquid with high mist retardant property.
- Down milling is recommended in side milling.
- Vibration and unusual noise may be generated if the machine rigidity and workpiece fixture stability is low, please reduce the rotating speed and feed rate like mentioned above.
- Make overhang as short as possible if no interference.

- Die obige Tabelle zeigt Standard Werte für das Eckfräsen. Bei Nutenfräsen, Schnittgeschwindigkeit auf 50-70% und den Vorschub auf 40-60% reduzieren.
- Bitte präzise Maschinen und Werkzeughalter verwenden.
- Bitte Luftkühlung oder Schneidflüssigkeit benutzen.
- Empfohlene Fräsmethode: Gleichlaufräsen.
- Bei Vibrationen oder unüblichen Geräuschen reduzieren Sie die Schnittdaten (wie oben empfohlen) entsprechend.
- Werkzeugauskrägung so kurz wie möglich wählen.

Recommended cutting data · Empfohlene Schnittdaten

GM-2Fi GM-2FL

Workpiece material Werkstückmaterial	Cast iron, Nodular cast iron Grauguss GGG		Carbon steel, Alloy steel Kohlenstoffstahl Leg. Stahl ~750N/mm ²		Carbon steel, Alloy steel Kohlenstoffstahl Leg. Stahl ~30HRC		Pre-hardened steel, Quenched and tempered steel Vergüteter Stahl ~40HRC		Stainless steel Rostfreier Stahl		Pre-hardened steel, Quenched and tempered steel Vergüteter Stahl ~50HRC	
	Diameter Ø Durchmesser (mm)	Rotating Drehzahl (min ⁻¹)	Feed Vorschub (mm/min)	Rotating Drehzahl (min ⁻¹)	Feed Vorschub (mm/min)	Rotating Drehzahl (min ⁻¹)	Feed Vorschub (mm/min)	Rotating Drehzahl (min ⁻¹)	Feed Vorschub (mm/min)	Rotating Drehzahl (min ⁻¹)	Feed Vorschub (mm/min)	Rotating Drehzahl (min ⁻¹)
1	20000	115	20000	115	20000	95	20000	95	20000	35	20000	70
2	15000	185	15000	185	15000	170	15000	165	11150	50	13000	105
3	14000	320	14000	320	13000	295	10600	245	7500	70	8500	190
4	10800	325	10800	325	10000	300	8000	250	5500	80	6500	195
5	8200	340	8200	340	7600	315	6400	260	4500	80	5000	205
6	7000	350	7000	350	6400	320	5300	270	3700	80	4200	210
8	5200	345	5200	345	4800	320	4000	265	2800	80	3200	210
10	4200	340	4200	340	3800	315	3200	260	2200	80	2500	200
12	3500	340	3500	340	3200	315	2650	260	1850	80	2100	200
14	3000	320	3000	320	2700	295	2300	245	1600	80	1800	190
16	2600	320	2600	320	2400	295	2000	245	1400	70	1600	190
18	2300	310	2300	310	2100	290	1800	240	1250	70	1400	190
20	2050	310	2050	310	1900	290	1600	240	1100	70	1250	190

Max. cutting depth max Schnitttiefe										
		<table border="1"> <thead> <tr> <th>Milling slot</th> <th>Nutenfräsen</th> </tr> <tr> <th>Ø</th> <th>Ap</th> </tr> </thead> <tbody> <tr> <td>Ø1 ≤ D < Ø3</td> <td>0.15D</td> </tr> <tr> <td>Ø3 ≤ D</td> <td>0.3D</td> </tr> </tbody> </table>	Milling slot	Nutenfräsen	Ø	Ap	Ø1 ≤ D < Ø3	0.15D	Ø3 ≤ D	0.3D
Milling slot	Nutenfräsen									
Ø	Ap									
Ø1 ≤ D < Ø3	0.15D									
Ø3 ≤ D	0.3D									

- The above table shows the standard value of side milling. When slot milling, of rotating speed 50%~70% and feed rate like mentioned above 40%~60%.
- Please select high precise machine and tool holder.
- Please use air blow or cutting liquid with high mist retardant property.
- Down milling is recommended in side milling.
- Vibration and unusual noise may be generated if the machine rigidity and workpiece fixture stability is low, please reduce the rotating speed and feed rate like mentioned above.
- Make overhang as short as possible if no interference.

- Die obige Tabelle zeigt Standard Werte für das Eckfräsen. Bei Nutenfräsen, Schnittgeschwindigkeit auf 50-70% und den Vorschub auf 40-60% reduzieren.
- Bitte präzise Maschinen und Werkzeughalter verwenden.
- Bitte Luftkühlung oder Schneidflüssigkeit benutzen.
- Empfohlene Fräsmethode: Gleichlaufräsen.
- Bei Vibrationen oder unüblichen Geräuschen reduzieren Sie die Schnittdaten (wie oben empfohlen) entsprechend.
- Werkzeugauskragung so kurz wie möglich wählen.

Milling · Fräsen

Solid Carbide end mills · Vollhartmetallschaftfräser

Recommended cutting data · Empfohlene Schnittdaten

GM-2EX

Workpiece material Werkstückmaterial	Cast iron, Nodular cast iron Grauguss GGG		Carbon steel, Alloy steel Kohlenstoffstahl Leg. Stahl ~750N/mm ²		Carbon steel, Alloy steel Kohlenstoffstahl Leg. Stahl ~30HRC		Pre-hardened steel, Quenched and tempered steel Vergüteter Stahl ~40HRC		Stainless steel Rostfreier Stahl		Pre-hardened steel, Quenched and tempered steel Vergüteter Stahl ~50HRC	
	Diameter Ø Durchmesser (mm)	Rotating Drehzahl (min ⁻¹)	Feed Vorschub (mm/min)	Rotating Drehzahl (min ⁻¹)	Feed Vorschub (mm/min)	Rotating Drehzahl (min ⁻¹)	Feed Vorschub (mm/min)	Rotating Drehzahl (min ⁻¹)	Feed Vorschub (mm/min)	Rotating Drehzahl (min ⁻¹)	Feed Vorschub (mm/min)	Rotating Drehzahl (min ⁻¹)
6	5800	375	5800	375	5300	345	4250	275	2650	60	3600	230
8	4400	375	4400	375	4000	345	3180	275	2000	60	2700	235
10	3500	365	3500	365	3200	330	2550	265	1600	60	2150	220
12	2900	365	2900	365	2650	330	2120	265	1350	60	1800	220
16	2200	345	2200	345	2000	315	1590	250	1000	50	1350	210
20	1750	340	1750	340	1600	310	1270	245	800	45	1050	205
Max. cutting depth max Schnitttiefe	<p>The diagram illustrates the maximum cutting depth parameters for the end mill. It shows a cross-section of the tool cutting into a workpiece. The axial cutting depth is labeled as $a_e = 0.02D$, where D is the diameter of the end mill. The radial cutting depth is labeled as $a_p = 3D$.</p>											

1. Please select high precise machine and tool holder.
2. Please use air blow or cutting liquid with high mist retardant property.
3. Down milling is recommended in side milling.
4. Vibration and unusual noise may be generated if the machine rigidity and workpiece fixture stability is low, please reduce the rotating speed and feed rate like mentioned above.
5. Make overhang as short as possible if no interference.

1. Bitte präzise Maschinen und Werkzeughalter verwenden.
2. Bitte Luftkühlung oder Schneidflüssigkeit benutzen.
3. Empfohlene Fräsmethode: Gleichlaufräsen.
4. Bei Vibrationen oder unüblichen Geräuschen reduzieren Sie die Schnittdaten (wie oben empfohlen) entsprechend.
5. Werkzeugauskragung so kurz wie möglich wählen.

B

Solid Carbide end mills
Vollhartmetallschaftfräser

Recommended cutting data · Empfohlene Schnittdaten

GM-2EFP

Workpiece material Werkstückmaterial	Cast iron, Nodular cast iron Grauguss GGG		Carbon steel, Alloy steel Kohlenstoffstahl Leg. Stahl ~750N/mm ²		Carbon steel, Alloy steel Kohlenstoffstahl Leg. Stahl ~30HRC		Pre-hardened steel, Quenched and tempered steel Vergüteter Stahl ~40HRC		Stainless steel Rostfreier Stahl		Pre-hardened steel, Quenched and tempered steel Vergüteter Stahl ~50HRC	
	Diameter Ø Durchmesser (mm)	Rotating Drehzahl (min ⁻¹)	Feed Vorschub (mm/min)	Rotating Drehzahl (min ⁻¹)	Feed Vorschub (mm/min)	Rotating Drehzahl (min ⁻¹)	Feed Vorschub (mm/min)	Rotating Drehzahl (min ⁻¹)	Feed Vorschub (mm/min)	Rotating Drehzahl (min ⁻¹)	Feed Vorschub (mm/min)	Rotating Drehzahl (min ⁻¹)
6	7000	650	7000	650	6400	600	5300	500	3700	150	4200	390
8	5200	645	5200	645	4800	590	4000	495	2800	150	3200	395
10	4200	630	4200	630	3800	585	3200	480	2200	150	2500	380
12	3500	630	3500	630	3200	585	2650	480	1850	150	2100	380
16	2600	590	2600	590	2400	545	2000	455	1400	130	1600	355
20	2050	580	2050	580	1900	530	1600	450	1100	130	1250	350

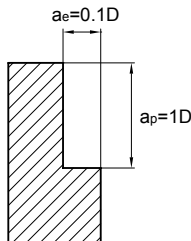
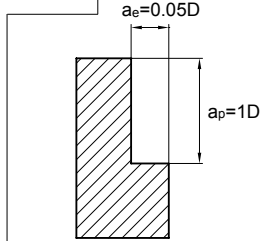
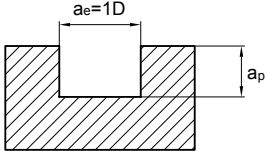
Max. cutting depth max. Schnitttiefe									
	 <table border="1" data-bbox="799 1151 1091 1272"> <thead> <tr> <th>Milling slot</th> <th>Nutenfräsen</th> </tr> </thead> <tbody> <tr> <td>Ø</td> <td>Ap</td> </tr> <tr> <td>Ø1 ≤ D < Ø3</td> <td>0.15D</td> </tr> <tr> <td>Ø3 ≤ D</td> <td>0.3D</td> </tr> </tbody> </table>	Milling slot	Nutenfräsen	Ø	Ap	Ø1 ≤ D < Ø3	0.15D	Ø3 ≤ D	0.3D
Milling slot	Nutenfräsen								
Ø	Ap								
Ø1 ≤ D < Ø3	0.15D								
Ø3 ≤ D	0.3D								

- The above table shows the standard value of side milling. When slot milling, of rotating speed 50%~70% and feed rate like mentioned above 40%~60%.
- Please select high precise machine and tool holder.
- Please use air blow or cutting liquid with high mist retardant property.
- Down milling is recommended in side milling.
- Vibration and unusual noise may be generated if the machine rigidity and workpiece fixture stability is low, please reduce the rotating speed and feed rate like mentioned above.
- Make overhang as short as possible if no interference.

- Die obige Tabelle zeigt Standard Werte für das Eckfräsen. Bei Nutenfräsen, Schnittgeschwindigkeit auf 50-70% und den Vorschub auf 40-60% reduzieren.
- Bitte präzise Maschinen und Werkzeughalter verwenden.
- Bitte Luftkühlung oder Schneidflüssigkeit benutzen.
- Empfohlene Fräsmethode: Gleichlaufräsen.
- Bei Vibrationen oder ungewöhnlichen Geräuschen reduzieren Sie die Schnittdaten (wie oben empfohlen) entsprechend.
- Werkzeugauskrägung so kurz wie möglich wählen.

Milling · Fräsen

Solid Carbide end mills · Vollhartmetallschaftfräser

GM-2EP series for general machining · GM-2EP Serie für allgemeine Bearbeitung

2-flute end mills with straight shank and short cutting edge and long neck
2-Schneiden Eckfräser mit kurzer Schneide und Zylinderschaft

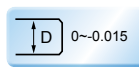
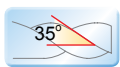
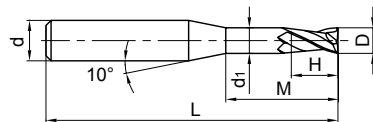

Type Typ	Dimension(mm) Abmessungen						Teeth Zähne Z	Grade Sorte KMG 303
	D	d	H	M	d1	L		
GM-2EP-D0.5-M04	0.5	4.0	0.7	4.0	0.45	50	2	●
GM-2EP-D0.5-M06	0.5	4.0	0.7	6.0	0.45	50	2	●
GM-2EP-D0.5-M08	0.5	4.0	0.7	8.0	0.45	50	2	●
GM-2EP-D0.8-M04	0.8	4.0	1.2	4.0	0.75	50	2	●
GM-2EP-D0.8-M06	0.8	4.0	1.2	6.0	0.75	50	2	●
GM-2EP-D0.8-M08	0.8	4.0	1.2	8.0	0.75	50	2	●
GM-2EP-D0.8-M10	0.8	4.0	1.2	10.0	0.75	50	2	●
GM-2EP-D1.0-M04	1.0	4.0	1.5	4.0	0.95	50	2	●
GM-2EP-D1.0-M06	1.0	4.0	1.5	6.0	0.95	50	2	●
GM-2EP-D1.0-M08	1.0	4.0	1.5	8.0	0.95	50	2	●
GM-2EP-D1.0-M10	1.0	4.0	1.5	10.0	0.95	50	2	●
GM-2EP-D1.0-M12	1.0	4.0	1.5	12.0	0.95	50	2	●
GM-2EP-D1.0-M14	1.0	4.0	1.5	14.0	0.95	50	2	●
GM-2EP-D1.2-M06	1.2	4.0	1.8	6.0	1.15	50	2	●
GM-2EP-D1.2-M08	1.2	4.0	1.8	8.0	1.15	50	2	●
GM-2EP-D1.2-M10	1.2	4.0	1.8	10.0	1.15	50	2	●
GM-2EP-D1.2-M12	1.2	4.0	1.8	12.0	1.15	50	2	○
GM-2EP-D1.5-M06	1.5	4.0	2.3	6.0	1.45	50	2	●
GM-2EP-D1.5-M08	1.5	4.0	2.3	8.0	1.45	50	2	●
GM-2EP-D1.5-M10	1.5	4.0	2.3	10.0	1.45	50	2	●
GM-2EP-D1.5-M12	1.5	4.0	2.3	12.0	1.45	50	2	●
GM-2EP-D1.5-M14	1.5	4.0	2.3	14.0	1.45	50	2	●
GM-2EP-D2.0-M06	2.0	4.0	3.0	6.0	1.95	50	2	●
GM-2EP-D2.0-M08	2.0	4.0	3.0	8.0	1.95	50	2	●

Material Overview · Material Übersicht

✓ = Very suitable · Sehr empfohlen
✓ = Suitable · Empfohlen

KMG303

		Workpiece material Werkstückstoff									
Carbon steel Kohlenstoff Stahl	Alloy steel Legierter Stahl	Quenched and tempered steel · Vergüteter Stahl		Hardened steel · Gehärteter Stahl		Stainless steel · Rostfreier Stahl	Cast iron, Nodular cast iron Grauguss GGG	Copper alloy Kupfer Leg	Aluminum alloy Alu Leg	Titanium alloy Titan Leg	Heat resist alloy warmfeste Leg
		~40HRC	~50HRC	~55HRC	~68HRC						
✓	✓	✓	✓			✓	✓				

● Ex Stock / ab Lager ○ On demand / auf Anfrage

GM-2EP series for general machining · GM-2EP Serie für allgemeine Bearbeitung

2-flute end mills with straight shank and short cutting edge and long neck
2-Schneiden Eckfräser mit kurzer Schneide und Zylinderschaft

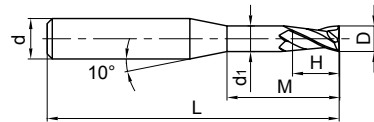
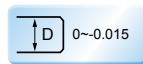
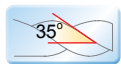

Type Typ	Dimension (mm) Abmessungen						Teeth Zähne Z	Grade Sorte KMG 303
	D	d	H	M	d ₁	L		
GM-2EP-D2.0-M10	2.0	4.0	3.0	10.0	1.95	50	2	●
GM-2EP-D2.0-M12	2.0	4.0	3.0	12.0	1.95	50	2	●
GM-2EP-D2.0-M14	2.0	4.0	3.0	14.0	1.95	50	2	●
GM-2EP-D2.0-M16	2.0	4.0	3.0	16.0	1.95	50	2	●
GM-2EP-D2.5-M08	2.5	4.0	3.7	8.0	2.4	50	2	●
GM-2EP-D2.5-M10	2.5	4.0	3.7	10.0	2.4	50	2	●
GM-2EP-D2.5-M12	2.5	4.0	3.7	12.0	2.4	50	2	●
GM-2EP-D2.5-M14	2.5	4.0	3.7	14.0	2.4	50	2	●
GM-2EP-D2.5-M16	2.5	4.0	3.7	16.0	2.4	60	2	●
GM-2EP-D2.5-M18	2.5	4.0	3.7	18.0	2.4	60	2	●
GM-2EP-D2.5-M20	2.5	4.0	3.7	20.0	2.4	60	2	●
GM-2EP-D3.0-M06	3.0	6.0	4.5	6.0	2.85	50	2	●
GM-2EP-D3.0-M08	3.0	6.0	4.5	8.0	2.85	50	2	●
GM-2EP-D3.0-M10	3.0	6.0	4.5	10.0	2.85	50	2	●
GM-2EP-D3.0-M12	3.0	6.0	4.5	12.0	2.85	50	2	●
GM-2EP-D3.0-M14	3.0	6.0	4.5	14.0	2.85	60	2	●
GM-2EP-D3.0-M16	3.0	6.0	4.5	16.0	2.85	60	2	●
GM-2EP-D3.0-M18	3.0	6.0	4.5	18.0	2.85	60	2	●
GM-2EP-D3.0-M20	3.0	6.0	4.5	20.0	2.85	60	2	●
GM-2EP-D4.0-M12	4.0	6.0	6.0	12.0	3.85	50	2	●
GM-2EP-D4.0-M14	4.0	6.0	6.0	14.0	3.85	60	2	●
GM-2EP-D4.0-M16	4.0	6.0	6.0	16.0	3.85	60	2	●
GM-2EP-D4.0-M20	4.0	6.0	6.0	20.0	3.85	60	2	●
GM-2EP-D4.0-M25	4.0	6.0	6.0	25.0	3.85	60	2	●
GM-2EP-D5.0-M16	5.0	6.0	7.5	16.0	4.85	60	2	●
GM-2EP-D5.0-M25	5.0	6.0	7.5	25.0	4.85	70	2	●

B

Solid Carbide end mills
Vollhartmetallschaftfräser

Material Overview · Material Übersicht

✓ = Very suitable · Sehr empfohlen
✓ = Suitable · Empfohlen

KMG303

Workpiece material Werkstückstoff											
Carbon steel Kohlenstoff Stahl	Alloy steel Legierter Stahl	Quenched and tempered steel · Vergüteter Stahl		Hardened steel · Gehärteter Stahl		Stainless steel · Rostfreier Stahl	Cast iron, Nodular cast iron Grauguss GGG	Copper alloy Kupfer Leg	Aluminum alloy Alu Leg	Titanium alloy Titan Leg	Heat resist alloy warmfeste Leg
		~40HRC	~50HRC	~55HRC	~68HRC						
✓	✓	✓	✓			✓	✓				

Code key B252-B254
ISO Kennzeichen

Cutting data B325-B327
Schnittdaten

Graphics identification & application B253-B255
Graphische Werkzeug- & Anwendungsbeschr.

Order form for non-standard products B534-B535
Bestellformular für Sonderwerkzeuge

Milling · Fräsen

Solid Carbide end mills · Vollhartmetallschaftfräser

GM-2ES series for general machining · **GM-2ES** Serie für allgemeine Bearbeitung

2-flute micro end mills with straight shank
2-Schneiden Mirco Eckfräser mit langer Schneide

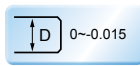
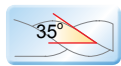
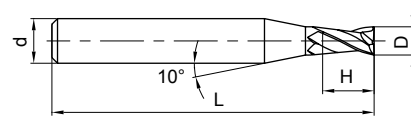

Type Typ	Dimension(mm) Abmessungen				Teeth Zähne Z	Grade Sorte KMG303
	D	d	H	L		
GM-2ES-D0.3	0.3	4.0	0.6	50	2	●
GM-2ES-D0.4	0.4	4.0	0.8	50	2	●
GM-2ES-D0.5	0.5	4.0	1.0	50	2	●
GM-2ES-D0.6	0.6	4.0	1.2	50	2	●
GM-2ES-D0.7	0.7	4.0	1.4	50	2	●
GM-2ES-D0.8	0.8	4.0	1.6	50	2	●
GM-2ES-D0.9	0.9	4.0	1.8	50	2	●
GM-2ES-D1.0	1.0	4.0	2.0	50	2	●
GM-2ES-D1.1	1.1	4.0	2.0	50	2	●
GM-2ES-D1.2	1.2	4.0	2.5	50	2	●
GM-2ES-D1.3	1.3	4.0	2.5	50	2	●
GM-2ES-D1.4	1.4	4.0	3.0	50	2	●
GM-2ES-D1.5	1.5	4.0	3.0	50	2	●
GM-2ES-D1.6	1.6	4.0	3.5	50	2	●
GM-2ES-D1.7	1.7	4.0	3.5	50	2	●
GM-2ES-D1.8	1.8	4.0	4.0	50	2	●
GM-2ES-D1.9	1.9	4.0	4.0	50	2	●
GM-2ES-D2.0	2.0	4.0	4.0	50	2	●
GM-2ES-D2.1	2.1	4.0	4.0	50	2	●
GM-2ES-D2.2	2.2	4.0	4.5	50	2	●
GM-2ES-D2.3	2.3	4.0	4.5	50	2	●
GM-2ES-D2.4	2.4	4.0	5.0	50	2	●
GM-2ES-D2.5	2.5	4.0	5.0	50	2	●
GM-2ES-D2.6	2.6	4.0	5.0	50	2	●
GM-2ES-D2.7	2.7	4.0	5.5	50	2	●
GM-2ES-D2.8	2.8	4.0	5.5	50	2	●
GM-2ES-D2.9	2.9	4.0	6.0	50	2	●
GM-2ES-D3.0	3.0	4.0	6.0	50	2	●

Material Overview · Material Übersicht

✓ = Very suitable · Sehr empfohlen
✓ = Suitable · Empfohlen

KMG303

		Workpiece material Werkstückstoff									
Carbon steel Kohlenstoff Stahl	Alloy steel Legierter Stahl	Quenched and tempered steel · Vergüteter Stahl		Hardened steel · Gehärteter Stahl		Stainless steel · Rostfreier Stahl	Cast iron, Nodular cast iron Grauguss GGG	Copper alloy Kupfer Leg	Aluminum alloy Alu Leg	Titanium alloy Titan Leg	Heat resist alloy warmfeste Leg
		~40HRC	~50HRC	~55HRC	~68HRC						
✓	✓	✓	✓			✓	✓				

● Ex Stock / ab Lager ○ On demand / auf Anfrage

Recommended cutting data · Empfohlene Schnittdaten

GM-2EP

Workpiece material Werkstückmaterial		Cast iron, Carbon steel, Alloy steel Kohlenstoffstahl Leg. Stahl ~750N/mm ²			Carbon steel, Alloy steel Kohlenstoffstahl Leg. Stahl ~30HRC			Pre-hardened steel, Quenched and tempered steel Vergüteter Stahl ~40HRC			Stainless steel Rostfreier Stahl		
Diameter Ø Durchmesser (mm)	Effective length Effektive Länge (mm)	Rotating Drehzahl (min ⁻¹)	Feed Vorschub (mm/min)	Ap (mm)	Rotating Drehzahl (min ⁻¹)	Feed Vorschub (mm/min)	Ap (mm)	Rotating Drehzahl (min ⁻¹)	Feed Vorschub (mm/min)	Ap (mm)	Rotating Drehzahl (min ⁻¹)	Feed Vorschub (mm/min)	Ap (mm)
0.5	4	28000	200	0.023	28000	175	0.021	28000	150	0.018	25000	100	0.014
	6	22000	150	0.007	22000	125	0.006	22000	100	0.005	20000	75	0.004
	8	18000	100	0.005	18000	75	0.005	18000	75	0.004	20000	50	0.003
0.8	4	32000	400	0.057	32000	350	0.053	32000	300	0.044	25000	200	0.035
	6	26000	300	0.036	26000	250	0.034	26000	200	0.028	21000	150	0.022
	8	22000	200	0.026	22000	150	0.024	22000	125	0.020	18000	100	0.016
	10	22000	150	0.01	22000	100	0.01	22000	75	0.008	18000	75	0.006
1.0	4	29000	800	0.08	27000	600	0.08	26000	400	0.07	20000	300	0.05
	6	29000	800	0.07	27000	600	0.07	26000	400	0.06	20000	300	0.04
	8	24000	600	0.05	23000	400	0.04	22000	300	0.04	18000	200	0.03
	10	20000	500	0.03	19000	400	0.03	18000	300	0.03	15000	200	0.02
	12	20000	300	0.02	19000	200	0.02	18000	175	0.02	15000	150	0.01
1.2	14	18000	200	0.015	15000	150	0.01	15000	125	0.01	12000	100	0.008
	6	25000	800	0.09	23000	600	0.08	22000	400	0.07	17000	300	0.05
	8	21000	600	0.07	20000	400	0.07	19000	300	0.05	14000	200	0.04
	10	21000	600	0.06	20000	400	0.05	19000	300	0.04	14000	200	0.03
1.5	12	18000	400	0.04	17000	300	0.04	16000	200	0.03	11000	150	0.02
	6	20000	800	0.15	18000	600	0.14	18000	400	0.11	14000	300	0.09
	8	19000	600	0.11	16000	400	0.10	15000	300	0.08	12000	200	0.07
	10	19000	600	0.09	16000	400	0.08	15000	300	0.06	12000	200	0.05
	12	19000	600	0.07	16000	400	0.06	15000	300	0.05	12000	200	0.04
2.0	14	19000	500	0.06	16000	350	0.05	15000	250	0.04	12000	180	0.03
	6	16000	800	0.34	15000	600	0.31	14000	450	0.26	11000	350	0.21
	8	16000	800	0.29	15000	600	0.26	14000	450	0.22	11000	350	0.18
	10	14000	600	0.26	1300	400	0.24	12000	300	0.20	9000	250	0.16
	12	14000	600	0.14	13000	400	0.13	12000	300	0.11	9000	250	0.09
2.0	14	14000	500	0.10	13000	350	0.11	12000	250	0.09	9000	200	0.07
	16	14000	400	0.08	13000	300	0.08	12000	200	0.07	9000	150	0.06

max. cutting depth
max Schnitttiefe

Ap (Once cutting depth)
(Einzelne Schnitttiefe)

Milling - Fräsen

Solid Carbide end mills - Vollhartmetallschaftfräser

Recommended cutting data - Empfohlene Schnittdaten

GM-2EP

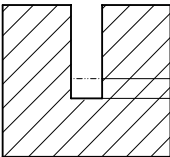
Workpiece material Werkstückmaterial		Cast iron, Carbon steel, Alloy steel Kohlenstoffstahl Leg. Stahl ~750N/mm ²			Carbon steel, Alloy steel Kohlenstoffstahl Leg. Stahl ~30HRC			Pre-hardened steel, Quenched and tempered steel Vergüteter Stahl ~40HRC			Stainless steel Rostfreier Stahl		
Diameter Ø Durchmesser (mm)	Effective length Effektive Länge (mm)	Rotating Drehzahl (min ⁻¹)	Feed Vorschub (mm/min)	Ap (mm)	Rotating Drehzahl (min ⁻¹)	Feed Vorschub (mm/min)	Ap (mm)	Rotating Drehzahl (min ⁻¹)	Feed Vorschub (mm/min)	Ap (mm)	Rotating Drehzahl (min ⁻¹)	Feed Vorschub (mm/min)	Ap (mm)
2.5	8	13000	800	0.42	12000	600	0.39	11000	450	0.33	9000	350	0.26
	10	13000	800	0.36	12000	600	0.33	11000	450	0.28	9000	350	0.22
	12	13000	800	0.24	12000	600	0.23	11000	450	0.19	9000	350	0.15
	14	12000	600	0.18	10000	400	0.17	9000	300	0.14	7000	250	0.11
	16	12000	600	0.13	10000	400	0.12	9000	300	0.09	7000	250	0.08
	18	12000	600	0.11	10000	350	0.10	9000	250	0.07	7000	200	0.07
3.0	20	12000	600	0.09	10000	350	0.08	9000	250	0.05	7000	200	0.05
	6	11000	800	0.42	10000	600	0.39	10000	450	0.32	8000	350	0.27
	8	11000	800	0.39	10000	600	0.36	10000	450	0.30	8000	350	0.24
	10	11000	800	0.31	10000	600	0.29	10000	450	0.24	8000	350	0.19
	12	11000	800	0.29	10000	500	0.27	10000	400	0.22	8000	300	0.16
	14	11000	600	0.27	10000	450	0.25	10000	350	0.20	8000	250	0.15
	16	10000	600	0.22	10000	400	0.20	9000	300	0.17	6000	200	0.13
4.0	18	10000	600	0.16	10000	400	0.14	9000	300	0.12	6000	200	0.10
	20	10000	500	0.12	10000	350	0.10	9000	250	0.08	6000	175	0.07
	12	8000	800	0.42	7000	600	0.38	7000	450	0.32	6000	350	0.26
	16	8000	800	0.39	7000	500	0.35	7000	400	0.30	6000	300	0.24
5.0	20	7000	600	0.34	7000	400	0.30	6000	350	0.27	5000	250	0.20
	25	7000	600	0.30	7000	400	0.27	6000	350	0.24	5000	250	0.15
	16	6000	800	0.49	6000	500	0.45	5000	400	0.38	5000	300	0.30
25	5000	800	0.45	5000	400	0.42	5000	350	0.35	5000	250	0.25	
Max. cutting depth max Schnitttiefe													

1. Please select high precise machine and tool holder.
2. Please use air blow or MQL (minimum oil mist cooling).
3. Make overhang as short as possible if no interference.
4. Reduce feed correspondingly when rotating speed is low.

1. Bitte präzise Maschine und Werkzeugaufnahmen wählen
2. Als Kühlmittel bitte Luft oder MQL (Minimalmengen) verwenden.
3. Werkzeugauskragung so kurz wie möglich wählen.
4. Bitte Vorschub entsprechend reduzieren, wenn die Drehzahlen niedrig sind.

Recommended cutting data · Empfohlene Schnittdaten

GM-2ES

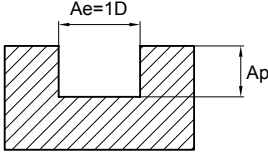
Workpiece material Werkstückmaterial	Cast iron, Nodular cast iron Grauguss GGG		Carbon steel, Alloy steel Kohlenstoffstahl Leg. Stahl ~750N/mm ²		Carbon steel, Alloy steel Kohlenstoffstahl Leg. Stahl ~30HRC		Pre-hardened steel, Quenched and tempered steel Vergüteter Stahl ~40HRC		Stainless steel Rostfreier Stahl									
	Diameter Ø Durchmesser (mm)	Rotating Drehzahl (min ⁻¹)	Feed Vorschub (mm/min)	Rotating Drehzahl (min ⁻¹)	Feed Vorschub (mm/min)	Rotating Drehzahl (min ⁻¹)	Feed Vorschub (mm/min)	Rotating Drehzahl (min ⁻¹)	Feed Vorschub (mm/min)	Rotating Drehzahl (min ⁻¹)	Feed Vorschub (mm/min)							
0.3	32000	115	32000	115	32000	115	32000	80	32000	40								
0.4	32000	125	32000	125	32000	125	32000	90	27500	50								
0.5	32000	125	32000	125	29500	125	25000	90	22000	50								
0.6	32000	125	32000	125	24500	125	21000	90	18500	50								
0.7	32000	125	32000	125	24500	125	21000	90	18500	50								
0.8	24500	125	24500	125	18500	125	15500	90	13500	50								
0.9	24500	125	24500	125	18500	125	15500	90	13500	50								
1.0	21000	140	25000	165	16800	130	14500	90	10000	50								
1.5	13000	140	15000	165	11800	130	10000	90	7000	50								
2.0	13000	160	15000	185	11800	145	10000	100	7000	60								
2.5	8700	200	10000	240	8200	185	6600	100	4700	60								
3.0	8700	235	10000	270	8200	220	6600	100	4700	75								
Max. cutting depth max Schnitttiefe	<div style="display: flex; align-items: center; justify-content: center;">  <table border="1" style="margin-left: 20px;"> <thead> <tr> <th colspan="2">Milling slot · Nutenfräsen</th> </tr> <tr> <th>Ø</th> <th>Ap</th> </tr> </thead> <tbody> <tr> <td>D < Ø1</td> <td>0.05D</td> </tr> <tr> <td>Ø1 ≤ D ≤ Ø3</td> <td>0.15D</td> </tr> </tbody> </table> </div>										Milling slot · Nutenfräsen		Ø	Ap	D < Ø1	0.05D	Ø1 ≤ D ≤ Ø3	0.15D
Milling slot · Nutenfräsen																		
Ø	Ap																	
D < Ø1	0.05D																	
Ø1 ≤ D ≤ Ø3	0.15D																	

1. Please select high precise machine and tool holder.
2. Please use air blow or cutting liquid with high mist retardant property.
3. Vibration and unusual noise may be generated if the machine rigidity and workpiece fixture stability is low, please reduce the rotating speed and feed rate like mentioned above.
4. Make overhang as short as possible if no interference.

1. Bitte präzise Maschine und Werkzeugaufnahmen wählen.
2. Als Kühlmittel bitte Luft oder MQL (Minimalmengen) verwenden..
3. Bei Vibrationen oder unüblichen Geräuschen reduzieren Sie die Schnittdaten (wie oben empfohlen) entsprechend.
4. Werkzeugauskragung so kurz wie möglich wählen.

Milling · Fräsen

Solid Carbide end mills · Vollhartmetallschaftfräser

GM-3E

3-flute flattened end mills with straight shank
3-Schneiden Eckfräser mit Zylinderschaft

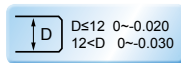
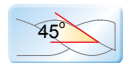
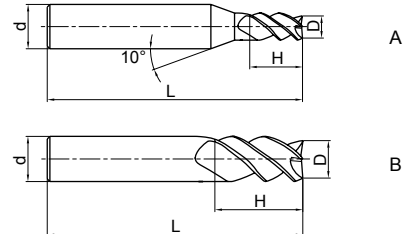

Type Typ	Dimension(mm) Abmessungen				Teeth Zähne Z	Geometry Ausführung	Grade Sorte KMG 303
	D	d	H	L			
GM-3E-D1.0S	1.0	4	3	50	3	A	●
GM-3E-D1.5S	1.5	4	4	50	3	A	●
GM-3E-D2.0S	2.0	4	6	50	3	A	●
GM-3E-D2.5S	2.5	4	8	50	3	A	●
GM-3E-D3.0S	3.0	4	8	50	3	A	●
GM-3E-D4.0S	4.0	4	11	50	3	B	●
GM-3E-D1.0	1.0	6	3	50	3	A	●
GM-3E-D1.5	1.5	6	4	50	3	A	●
GM-3E-D2.0	2.0	6	6	50	3	A	●
GM-3E-D2.5	2.5	6	8	50	3	A	●
GM-3E-D3.0	3.0	6	8	50	3	A	●
GM-3E-D3.5	3.5	6	10	50	3	A	●
GM-3E-D4.0	4.0	6	11	50	3	A	●
GM-3E-D4.5	4.5	6	11	50	3	A	●
GM-3E-D5.0	5.0	6	13	50	3	A	●
GM-3E-D5.5	5.5	6	16	50	3	A	●
GM-3E-D6.0	6.0	6	16	50	3	B	●
GM-3E-D7.0	7.0	8	20	60	3	A	●
GM-3E-D8.0	8.0	8	20	60	3	B	●
GM-3E-D9.0	9.0	10	22	75	3	A	●
GM-3E-D10.0	10.0	10	25	75	3	B	●
GM-3E-D11.0	11.0	12	26	75	3	A	●
GM-3E-D12.0	12.0	12	30	75	3	B	●
GM-3E-D14.0	14.0	14	32	75	3	B	●
GM-3E-D16.0	16.0	16	45	100	3	B	●
GM-3E-D18.0	18.0	18	45	100	3	B	●
GM-3E-D20.0	20.0	20	45	100	3	B	●

B

Solid Carbide end mills
Vollhartmetallschaftfräser

Material Overview · Material Übersicht

✓ = Very suitable · Sehr empfohlen
✓ = Suitable · Empfohlen

KMG303

		Workpiece material Werkstückstoff									
Carbon steel Kohlenstoff Stahl	Alloy steel Legierter Stahl	Quenched and tempered steel · Vergüteter Stahl		Hardened steel · Gehärteter Stahl		Stainless steel · Rostfreier Stahl	Cast iron, Nodular cast iron Grauguss GGG	Copper alloy Kupfer Leg	Aluminum alloy Alu Leg	Titanium alloy Titan Leg	Heat resist alloy warmfeste Leg
		~40HRC	~50HRC	~55HRC	~68HRC						
✓	✓	✓	✓			✓	✓				

● Ex Stock / ab Lager ○ On demand / auf Anfrage

GM-3EL

3-flute end mills with straight shank and long cutting edge and long neck
 3-Schneiden Eckfräser mit langer Schneide und Zylinderschaft

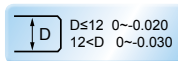
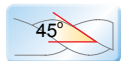
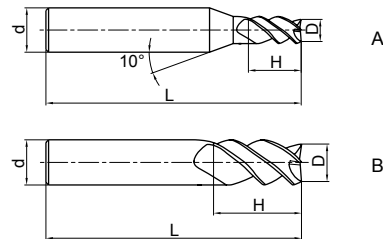

Type Typ	Dimension (mm) Abmessungen				Teeth Zähne Z	Geometry Ausführung	Grade Sorte KMG 303
	D	d	H	L			
GM-3EL-D3.0	3.0	6	12	75	3	A	●
GM-3EL-D4.0	4.0	6	15	75	3	A	●
GM-3EL-D5.0	5.0	6	20	75	3	A	●
GM-3EL-D6.0	6.0	6	20	75	3	B	●
GM-3EL-D8.0	8.0	8	25	100	3	B	●
GM-3EL-D10.0	10.0	10	30	100	3	B	●
GM-3EL-D12.0	12.0	12	35	100	3	B	●
GM-3EL-D14.0	14.0	14	40	100	3	B	●
GM-3EL-D16.0	16.0	16	50	150	3	B	●
GM-3EL-D20.0	20.0	20	55	150	3	B	●

B

Solid Carbide end mills
 Vollhartmetallschaftfräser

Material Overview · Material Übersicht

✓ = Very suitable · Sehr empfohlen
 ✓ = Suitable · Empfohlen

KMG303

Workpiece material Werkstückstoff											
Carbon steel Kohlenstoff Stahl	Alloy steel Legierter Stahl	Quenched and tempered steel · Vergüteter Stahl		Hardened steel · Gehärteter Stahl		Stainless steel · Rostfreier Stahl	Cast iron, Nodular cast iron Grauguss GGG	Copper alloy Kupfer Leg	Aluminum alloy Alu Leg	Titanium alloy Titan Leg	Heat resist alloy warmfeste Leg
		~40HRC	~50HRC	~55HRC	~68HRC						
✓	✓	✓	✓			✓	✓				

Code key **B252-B254**
 ISO Kennzeichen

Cutting data **B336-B339**
 Schnittdaten

Graphics identification & application **B253-B255**
 Graphische Werkzeug- & Anwendungsbeschr.

Order form for non-standard products **B534-B535**
 Bestellformular für Sonderwerkzeuge

Milling · Fräsen

Solid Carbide end mills · Vollhartmetallschaftfräser

DIN 6527K 3-flute slotting end mills · **DIN 6527K** 3-Schneiden VHM Langlochfräser

5501R303GM

YK30F: Ultra-fine carbide grade / *Ultrafeinkornhartmetall*

KMG303: nano AlTiN Coated Ultra-fine Carbide / *nano AlTiN beschichtetes Ultrafeinkornhartmetall*

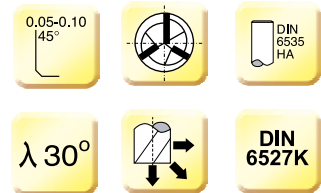
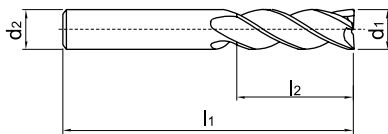

B

Solid Carbide end mills
Vollhartmetallschaftfräser

Type Typ	Dimension(mm) Abmessungen				Teeth Zähne	Application Anwendung	P M K	
	d1(e8)	d2(h6)	l2	l1			Grade Sorte	YK30F
5501R303GM-0300	3.00	6	4	50	3		○	●
5501R303GM-0400	4.00	6	5	54	3		○	●
5501R303GM-0500	5.00	6	6	54	3		○	●
5501R303GM-0600	6.00	6	7	54	3		○	●
5501R303GM-0800	8.00	8	9	58	3		○	●
5501R303GM-1000	10.00	10	11	66	3		○	●
5501R303GM-1200	12.00	12	12	73	3		○	●
5501R303GM-1400	14.00	14	14	75	3		○	●
5501R303GM-1600	16.00	16	16	82	3		○	●
5501R303GM-1800	18.00	18	18	84	3		○	●
5501R303GM-2000	20.00	20	20	92	3		○	●
Art. Group No. / Produktgruppe Nr. :							021140	021130

Material Overview · Material Übersicht

✓ = Very suitable · Sehr empfohlen
✓ = Suitable · Empfohlen

KMG303

Workpiece material Werkstückstoff											
Carbon steel Kohlenstoff Stahl	Alloy steel Legierter Stahl	Quenched and tempered steel · Vergüteter Stahl		Hardened steel · Gehärteter Stahl		Stainless steel · Rostfreier Stahl	Cast iron, Nodular cast iron Grauguss GGG	Copper alloy Kupfer Leg	Aluminum alloy Alu Leg	Titanium alloy Titan Leg	Heat resist alloy warmfeste Leg
		~40HRC	~50HRC	~55HRC	~68HRC						
✓	✓	✓	✓			✓	✓				

● Ex Stock / ab Lager ○ On demand / auf Anfrage

DIN 6527K 3-flute slotting end mills · DIN 6527K 3-Schneiden VHM Langlochfräser

5601R303GM

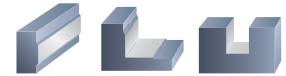

YK30F: Ultra-fine carbide grade / Ultrafeinkornhartmetall

KMG303: nano AlTiN Coated Ultra-fine Carbide / nano AlTiN beschichtetes Ultrafeinkornhartmetall

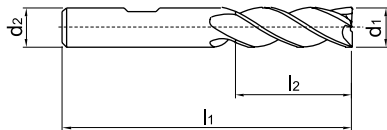

Type Typ	Dimension(mm) Abmessungen				Teeth Zähne	Application Anwendung	P M K	
	d1(e8)	d2(h6)	l2	l1			Grade Sorte	YK30F
5601R303GM-0300	3.00	6	4	50	3		○	●
5601R303GM-0400	4.00	6	5	54	3		○	●
5601R303GM-0500	5.00	6	6	54	3		○	●
5601R303GM-0600	6.00	6	7	54	3		○	●
5601R303GM-0800	8.00	8	9	58	3		○	●
5601R303GM-1000	10.00	10	11	66	3		○	●
5601R303GM-1200	12.00	12	12	73	3		○	●
5601R303GM-1400	14.00	14	14	75	3		○	●
5601R303GM-1600	16.00	16	16	82	3		○	●
5601R303GM-1800	18.00	18	18	84	3		○	●
5601R303GM-2000	20.00	20	20	92	3		○	●
Art. Group No. / Produktgruppe Nr. :							021140	021130

B

Solid Carbide end mills
Vollhartmetallschaftfräser

Material Overview · Material Übersicht

✓ = Very suitable · Sehr empfohlen
✓ = Suitable · Empfohlen

KMG303

Workpiece material Werkstückstoff											
Carbon steel Kohlenstoff Stahl	Alloy steel Legierter Stahl	Quenched and tempered steel · Vergüteter Stahl		Hardened steel · Gehärteter Stahl		Stainless steel · Rostfreier Stahl	Cast iron, Nodular cast iron Grauguss GGG	Copper alloy Kupfer Leg	Aluminum alloy Alu Leg	Titanium alloy Titan Leg	Heat resist alloy warmfeste Leg
		~40HRC	~50HRC	~55HRC	~68HRC						
✓	✓	✓	✓			✓	✓				

Code key B252-B254
ISO Kennzeichen

Cutting data B336-B339
Schnittdaten

Graphics identification & application B253-B255
Graphische Werkzeug- & Anwendungsbeschr.

Order form for non-standard products B534-B535
Bestellformular für Sonderwerkzeuge

Milling · Fräsen

Solid Carbide end mills · Vollhartmetallschaftfräser

DIN 6527L 3-flute slotting end mills · DIN 6527L 3-Schneiden VHM Langlochfräser



5502R303GM

YK30F: Ultra-fine carbide grade / Ultrafeinkornhartmetall

KMG303: nano AlTiN Coated Ultra-fine Carbide / nano AlTiN beschichtetes Ultrafeinkornhartmetall

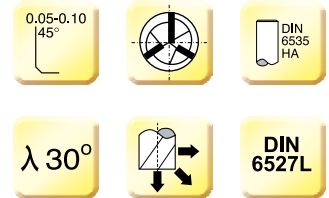
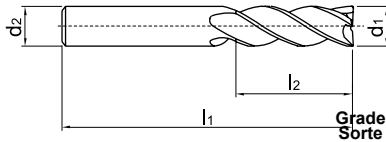

Type Typ	Dimension(mm) Abmessungen				Teeth Zähne	Application Anwendung	P M K	
	d1(e8)	d2(h6)	l2	l1			Grade Sorte	YK30F
5502R303GM-0300	3.00	6	7	57	3		○	●
5502R303GM-0400	4.00	6	8	57	3		○	●
5502R303GM-0500	5.00	6	10	57	3		○	●
5502R303GM-0600	6.00	6	10	57	3		○	●
5502R303GM-0800	8.00	8	16	63	3		○	●
5502R303GM-1000	10.00	10	19	72	3		○	●
5502R303GM-1200	12.00	12	22	83	3		○	●
5502R303GM-1400	14.00	14	22	83	3		○	●
5502R303GM-1600	16.00	16	26	92	3		○	●
5502R303GM-1800	18.00	18	26	92	3		○	●
5502R303GM-2000	20.00	20	32	104	3		○	●
Art. Group No. / Produktgruppe Nr. :							021140	021130

B

Solid Carbide end mills
Vollhartmetallschaftfräser

Material Overview · Material Übersicht

✓ = Very suitable · Sehr empfohlen
✓ = Suitable · Empfohlen

KMG303	Workpiece material Werkstückstoff											
	Carbon steel Kohlenstoff Stahl	Alloy steel Legierter Stahl	Quenched and tempered steel · Vergüteter Stahl		Hardened steel · Gehärteter Stahl		Stainless steel · Rostfreier Stahl	Cast iron, Nodular cast iron Grauguss GGG	Copper alloy Kupfer Leg	Aluminum alloy Alu Leg	Titanium alloy Titan Leg	Heat resist alloy warmfeste Leg
			~40HRC	~50HRC	~55HRC	~68HRC						
	✓	✓	✓	✓			✓	✓				

● Ex Stock / ab Lager ○ On demand / auf Anfrage

DIN 6527L 3-flute slotting end mills · DIN 6527L 3-Schneiden VHM Langlochfräser

5602R303GM

YK30F: Ultra-fine carbide grade / *Ultrafeinkornhartmetall*
 KMG303: nano AlTiN Coated Ultra-fine Carbide / *nano AlTiN beschichtetes Ultrafeinkornhartmetall*

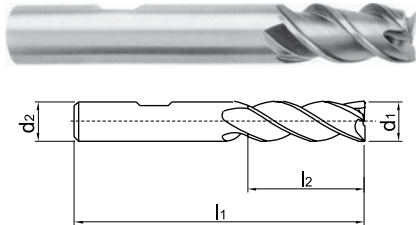

Type Typ	Dimension(mm) Abmessungen				Teeth Zähne	Application Anwendung	P M K	
	d1(e8)	d2(h6)	l2	l1			z	Grade Sorte
5602R303GM-0300	3.00	6	7	57	3		○	●
5602R303GM-0400	4.00	6	8	57	3		○	●
5602R303GM-0500	5.00	6	10	57	3		○	●
5602R303GM-0600	6.00	6	10	57	3		○	●
5602R303GM-0800	8.00	8	16	63	3		○	●
5602R303GM-1000	10.00	10	19	72	3		○	●
5602R303GM-1200	12.00	12	22	83	3		○	●
5602R303GM-1400	14.00	14	22	83	3		○	●
5602R303GM-1600	16.00	16	26	92	3		○	●
5602R303GM-1800	18.00	18	26	92	3		○	●
5602R303GM-2000	20.00	20	32	104	3		○	●
Art. Group No. / Produktgruppe Nr. :							021140	021130

B

Solid Carbide end mills
Vollhartmetallschaftfräser

Material Overview · Material Übersicht

✓ = Very suitable · Sehr empfohlen
 ✓ = Suitable · Empfohlen

KMG303

Workpiece material Werkstückstoff											
Carbon steel Kohlenstoff Stahl	Alloy steel Legierter Stahl	Quenched and tempered steel · Vergüteter Stahl		Hardened steel · Gehärteter Stahl		Stainless steel · Rostfreier Stahl	Cast iron, Nodular cast iron Grauguss GGG	Copper alloy Kupfer Leg	Aluminum alloy Alu Leg	Titanium alloy Titan Leg	Heat resist alloy warmfeste Leg
		~40HRC	~50HRC	~55HRC	~68HRC						
✓	✓	✓	✓			✓	✓				

Code key B252,B254
ISO Kennzeichen

Cutting data B336-B339
Schnittdaten

Graphics identification & application B253-B255
Graphische Werkzeug- & Anwendungsbeschr.

Order form for non-standard products B534-B535
Bestellformular für Sonderwerkzeuge

Milling · Fräsen

Solid Carbide end mills · Vollhartmetallschaftfräser

DIN 6527L 3-flute end mills · DIN 6527L 3-Schneiden VHM Schaftfräser



5502R453GM

KMG405: nano TiAlN coated ultra-fine carbide / nano TiAlN beschichtetes Ultrafeinkornhartmetall

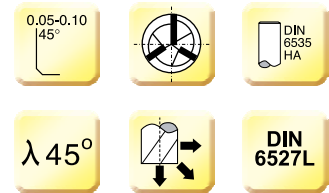
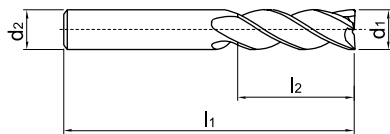

Type Typ	Dimension(mm) Abmessungen				Teeth Zähne	Application Anwendung	Grade Sorte	P M K S
	d1(e8)	d2(h6)	l2	l1				
5502R453GM-0300	3.00	6	7	57	3		●	
5502R453GM-0400	4.00	6	8	57	3		●	
5502R453GM-0500	5.00	6	10	57	3		●	
5502R453GM-0600	6.00	6	10	57	3		●	
5502R453GM-0800	8.00	8	16	63	3		●	
5502R453GM-1000	10.00	10	19	72	3		●	
5502R453GM-1200	12.00	12	22	83	3		●	
5502R453GM-1400	14.00	14	22	83	3		●	
5502R453GM-1600	16.00	16	26	92	3		●	
5502R453GM-1800	18.00	18	26	92	3		●	
5502R453GM-2000	20.00	20	32	104	3		○	

Art. Group No. / Produktgruppe Nr. : 021130

Material Overview · Material Übersicht

✓ = Very suitable · Sehr empfohlen
 ✓ = Suitable · Empfohlen

KMG405

Workpiece material Werkstückstoff											
Carbon steel Kohlenstoff Stahl	Alloy steel Legierter Stahl	Quenched and tempered steel · Vergüteter Stahl		Hardened steel · Gehärteter Stahl		Stainless steel · Rostfreier Stahl	Cast iron, Nodular cast iron Grauguss GGG	Copper alloy Kupfer Leg	Aluminum alloy Alu Leg	Titanium alloy Titan Leg	Heat resist alloy warmfeste Leg
		~40HRC	~50HRC	~55HRC	~68HRC						
✓	✓	✓	✓			✓	✓				

● Ex Stock / ab Lager ○ On demand / auf Anfrage

DIN 6527L 3-flute end mills · DIN 6527L 3-Schneiden VHM Schaftfräser



5602R453GM

KMG405: nano TiAlN coated ultra-fine carbide / nano TiAlN beschichtetes Ultrafeinkornhartmetall
 KMG303: nano AlTiN coated Ultra-fine carbide / nano AlTiN beschichtetes Ultrafeinkornhartmetall

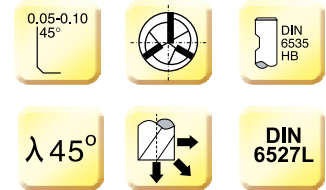
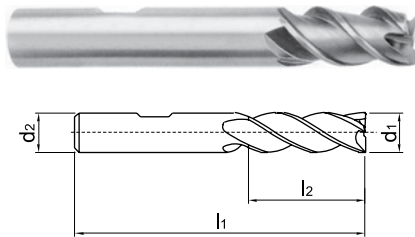

Type Typ	Dimension(mm) Abmessungen				Teeth Zähne	Application Anwendung	P M K	
	d1(e8)	d2(h6)	l2	l1			Grade Sorte	KMG303
5602R453GM-0300	3.00	6	7	57	3		●	●
5602R453GM-0400	4.00	6	8	57	3		●	●
5602R453GM-0500	5.00	6	10	57	3		●	●
5602R453GM-0600	6.00	6	10	57	3		●	●
5602R453GM-0800	8.00	8	16	63	3		●	●
5602R453GM-1000	10.00	10	19	72	3		●	●
5602R453GM-1200	12.00	12	22	83	3		●	●
5602R453GM-1400	14.00	14	22	83	3		●	●
5602R453GM-1600	16.00	16	26	92	3		●	●
5602R453GM-1800	18.00	18	26	92	3		●	●
5602R453GM-2000	20.00	20	32	104	3		●	●
Art. Group No. / Produktgruppe Nr. :							021130	

B

Solid Carbide end mills
Vollhartmetallschaftfräser

Material Overview · Material Übersicht

✓ = Very suitable · Sehr empfohlen
 ✓ = Suitable · Empfohlen

KMG405

Workpiece material Werkstückstoff											
Carbon steel Kohlenstoff Stahl	Alloy steel Legierter Stahl	Quenched and tempered steel · Vergüteter Stahl		Hardened steel · Gehärteter Stahl		Stainless steel · Rostfreier Stahl	Cast iron, Nodular cast iron Grauguss GGG	Copper alloy Kupfer Leg	Aluminum alloy Alu Leg	Titanium alloy Titan Leg	Heat resist alloy warmfeste Leg
		~40HRC	~50HRC	~55HRC	~68HRC						
✓	✓	✓	✓			✓	✓			✓	✓

Code key **B252-B254**
ISO Kennzeichen

Cutting data **B336-B339**
Schnittdaten

Graphics identification & application **B253-B255**
Graphische Werkzeug- & Anwendungsbeschr.

Order form for non-standard products **B534-B535**
Bestellformular für Sonderwerkzeuge

Milling - Fräsen

Solid Carbide end mills - Vollhartmetallschaftfräser

Recommended cutting data - Empfohlene Schnittdaten

Type Typ	Grade Sorte	Material Werkstoffe	d1 (mm)	z	Vc (m/min)	fz (mm/z)	ap (mm)	ae (mm)	n (min ⁻¹)	Vf (mm/min)
5501R303GM	KMG303	Steel Stahl HRC<25	3.00	3	100	0.010	1.50	3.00	10610	318
5601R303GM	KMG303		4.00	3	100	0.015	2.00	4.00	7950	358
			5.00	3	100	0.020	2.50	5.00	6360	382
			6.00	3	100	0.024	3.00	6.00	5300	382
			8.00	3	100	0.032	4.00	8.00	3970	381
			10.00	3	100	0.038	5.00	10.00	3180	363
			12.00	3	100	0.046	6.00	12.00	2650	366
			16.00	3	100	0.054	8.00	16.00	1980	321
			20.00	3	100	0.066	10.00	20.00	1590	315
			3.00	3	70	0.010	1.50	3.00	7420	223
			4.00	3	70	0.015	2.00	4.00	5570	251
			5.00	3	70	0.020	2.50	5.00	4450	267
			6.00	3	70	0.024	3.00	6.00	3710	267
			8.00	3	70	0.032	4.00	8.00	2780	267
			10.00	3	70	0.038	5.00	10.00	2220	253
			12.00	3	70	0.046	6.00	12.00	1850	255
		16.00	3	70	0.054	8.00	16.00	1390	225	
		20.00	3	70	0.066	10.00	20.00	1110	220	
		3.00	3	35	0.010	1.50	3.00	3710	111	
		4.00	3	35	0.015	2.00	4.00	2780	125	
		5.00	3	35	0.020	2.50	5.00	2220	133	
		6.00	3	35	0.024	3.00	6.00	1850	133	
		8.00	3	35	0.032	4.00	8.00	1390	133	
		10.00	3	35	0.038	5.00	10.00	1110	127	
		12.00	3	35	0.046	6.00	12.00	920	127	
		16.00	3	35	0.054	8.00	16.00	690	112	
		20.00	3	35	0.066	10.00	20.00	550	109	
		3.00	3	115	0.010	1.50	3.00	12200	366	
		4.00	3	115	0.015	2.00	4.00	9150	412	
		5.00	3	115	0.020	2.50	5.00	7320	439	
		6.00	3	115	0.024	3.00	6.00	6100	439	
		8.00	3	115	0.032	4.00	8.00	4570	439	
		10.00	3	115	0.038	5.00	10.00	3660	417	
		12.00	3	115	0.046	6.00	12.00	3050	421	
		16.00	3	115	0.054	8.00	16.00	2280	369	
		20.00	3	115	0.066	10.00	20.00	1830	362	
		3.00	3	210	0.010	1.50	3.00	22280	668	
		4.00	3	210	0.015	2.00	4.00	16710	752	
		5.00	3	210	0.020	2.50	5.00	13360	802	
		6.00	3	210	0.024	3.00	6.00	11140	802	
		8.00	3	210	0.032	4.00	8.00	8350	802	
		10.00	3	210	0.038	5.00	10.00	6680	762	
		12.00	3	210	0.046	6.00	12.00	5570	769	
		16.00	3	210	0.054	8.00	16.00	4170	676	
		20.00	3	210	0.066	10.00	20.00	3340	661	
		3.00	3	85	0.010	1.50	3.00	9010	270	
		4.00	3	85	0.015	2.00	4.00	6760	304	
		5.00	3	85	0.020	2.50	5.00	5410	325	
		6.00	3	85	0.024	3.00	6.00	4500	324	
		8.00	3	85	0.032	4.00	8.00	3380	324	
		10.00	3	85	0.038	5.00	10.00	2700	308	
		12.00	3	85	0.046	6.00	12.00	2250	311	
		16.00	3	85	0.054	8.00	16.00	1690	274	
		20.00	3	85	0.066	10.00	20.00	1350	267	

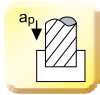

- Please start a test cutting with 85% of the Vc or 75% of the fz, then increase the cutting speed and feed rate.
- Please use high precision and high rigidity clamping system. The oscillation of the tool can not be over 0.01 mm.
- When $ap=1*d1$, $fz = 75%$ as the data in the table.
- Bitte führen Sie einen Testschnitt mit 85% der Vc und 75% des fz durch. Nach erfolgreichem Test können Sie die Schnittgeschwindigkeit bzw. die Vorschubwerte entsprechend erhöhen.
- Bitte verwenden Sie nur Spannmittel mit einer hohen Genauigkeit und einer hohen Spannkraft. Überprüfen Sie den Rundlauf der Werkzeuge. Sie sollten darauf achten, dass der Rundlauffehler nicht größer als 0.01 mm ist.
- Bei Fräsoperationen, die mit einer $ap=1*d1$ durchgeführt werden, ist fz um 25% zu reduzieren.

Recommended cutting data · Empfohlene Schnittdaten

Type Typ	Grade Sorte	Material Werkstoffe	d ₁ (mm)	z	V _c (m/min)	f _z (mm/z)	a _p (mm)	a _e (mm)	n (min ⁻¹)	V _f (mm/min)
5502R303GM	KMG303	Steel Stahl HRC<25	3.00	3	120	0.010	1.50	0.75	12730	382
5602R303GM	KMG303		4.00	3	120	0.015	2.00	1.00	9540	429
			5.00	3	120	0.020	2.50	1.25	7630	458
			6.00	3	120	0.024	3.00	1.50	6360	458
			8.00	3	120	0.032	4.00	2.00	4770	458
			10.00	3	120	0.038	5.00	2.50	3810	434
			12.00	3	120	0.046	6.00	3.00	3180	439
			16.00	3	120	0.054	8.00	4.00	2380	386
			20.00	3	120	0.066	10.00	5.00	1900	376
			3.00	3	90	0.010	1.50	0.75	9540	286
			4.00	3	90	0.015	2.00	1.00	7160	322
			5.00	3	90	0.020	2.50	1.25	5720	343
			6.00	3	90	0.024	3.00	1.50	4770	343
			8.00	3	90	0.032	4.00	2.00	3580	344
			10.00	3	90	0.038	5.00	2.50	2860	326
			12.00	3	90	0.046	6.00	3.00	2380	328
		16.00	3	90	0.054	8.00	4.00	1790	290	
		20.00	3	90	0.066	10.00	5.00	1430	283	
		3.00	3	40	0.010	1.50	0.75	4240	127	
		4.00	3	40	0.015	2.00	1.00	3180	143	
		5.00	3	40	0.020	2.50	1.25	2540	152	
		6.00	3	40	0.024	3.00	1.50	2120	153	
		8.00	3	40	0.032	4.00	2.00	1590	153	
		10.00	3	40	0.038	5.00	2.50	1270	145	
		12.00	3	40	0.046	6.00	3.00	1060	146	
		16.00	3	40	0.054	8.00	4.00	790	128	
		20.00	3	40	0.066	10.00	5.00	630	125	
		3.00	3	150	0.010	1.50	0.75	15910	477	
		4.00	3	150	0.015	2.00	1.00	11930	537	
		5.00	3	150	0.022	2.50	1.25	9540	630	
		6.00	3	150	0.027	3.00	1.50	7950	644	
		8.00	3	150	0.035	4.00	2.00	5960	626	
		10.00	3	150	0.044	5.00	2.50	4770	630	
		12.00	3	150	0.052	6.00	3.00	3970	619	
		16.00	3	150	0.063	8.00	4.00	2980	563	
		20.00	3	150	0.080	10.00	5.00	2380	571	
		3.00	3	300	0.015	1.50	0.75	31830	1432	
		4.00	3	300	0.020	2.00	1.00	23870	1432	
		5.00	3	300	0.025	2.50	1.25	19090	1432	
		6.00	3	300	0.029	3.00	1.50	15910	1384	
		8.00	3	300	0.042	4.00	2.00	11930	1503	
		10.00	3	300	0.050	5.00	2.50	9540	1431	
		12.00	3	300	0.059	6.00	3.00	7950	1407	
		16.00	3	300	0.072	8.00	4.00	5960	1287	
		20.00	3	300	0.090	10.00	5.00	4770	1288	
		3.00	3	150	0.015	1.50	0.75	15910	716	
		4.00	3	150	0.020	2.00	1.00	11930	716	
		5.00	3	150	0.025	2.50	1.25	9540	716	
		6.00	3	150	0.029	3.00	1.50	7950	692	
		8.00	3	150	0.042	4.00	2.00	5960	751	
		10.00	3	150	0.050	5.00	2.50	4770	716	
		12.00	3	150	0.059	6.00	3.00	3970	703	
		16.00	3	150	0.072	8.00	4.00	2980	644	
		20.00	3	150	0.090	10.00	5.00	2380	643	

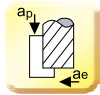

- Please start a test cutting with 85% of the V_c or 75% of the f_z, then increase the cutting speed and feed rate.
- Please use high precision and high rigidity clamping system. The oscillation of the tool can not be over 0.01 mm.
- When a_p=1*d₁, f_z = 75% as the data in the table.
- Recommended operation: climb milling.

- Bitte führen Sie einen Testschnitt mit 85% der V_c und 75% des f_z durch. Nach erfolgtem Test können Sie die Schnittgeschwindigkeit bzw. die Vorschubwerte entsprechend erhöhen.
- Bitte verwenden Sie nur Spannmittel mit einer hohen Genauigkeit und einer hohen Spannkraft. Überprüfen Sie den Rundlauf der Werkzeuge. Sie sollten darauf achten, dass der Rundlauffehler nicht größer als 0.01 mm ist.
- Bei Fräsoperationen, die mit einer a_p=1*d₁ durchgeführt werden, ist f_z um 25% zu reduzieren.
- Empfohlene Fräsmethode: Gleichlaufräsen.

Milling - Fräsen

Solid Carbide end mills - Vollhartmetallschaftfräser

Recommended cutting data - Empfohlene Schnittdaten

Type Typ	Grade Sorte	Material Werkstoffe	d1 (mm)	z	Vc (m/min)	fz (mm/z)	ap (mm)	ae (mm)	n (min ⁻¹)	Vf (mm/min)	
5502R453GM	KMG405	Steel Stahl HRC<25	3.00	3	120	0.010	4.50	0.30	12730	382	
5602R453GM	KMG405		4.00	3	120	0.015	6.00	0.40	9540	429	
			5.00	3	120	0.020	7.50	0.50	7630	458	
			6.00	3	120	0.024	9.00	0.60	6360	458	
			8.00	3	120	0.032	12.00	0.80	4770	458	
			10.00	3	120	0.038	15.00	1.00	3810	434	
			12.00	3	120	0.046	18.00	1.20	3180	439	
			16.00	3	120	0.054	24.00	1.60	2380	386	
			20.00	3	120	0.066	30.00	2.00	1900	376	
			Steel, Steel alloy Stahl, legierter Stahl HRC=25-38	3.00	3	90	0.010	4.50	0.30	9540	286
				4.00	3	90	0.015	6.00	0.40	7160	322
				5.00	3	90	0.020	7.50	0.50	5720	343
				6.00	3	90	0.024	9.00	0.60	4770	343
				8.00	3	90	0.032	12.00	0.80	3580	344
				10.00	3	90	0.038	15.00	1.00	2860	326
				12.00	3	90	0.046	18.00	1.20	2380	328
		16.00		3	90	0.054	24.00	1.60	1790	290	
			20.00	3	90	0.066	30.00	2.00	1430	283	
		High ally steel Hochlegierter Stahl	3.00	3	50	0.010	4.50	0.30	5300	159	
			4.00	3	50	0.015	6.00	0.40	3970	179	
		Stainless steel Rostfreier Stahl	5.00	3	50	0.020	7.50	0.50	3180	191	
			6.00	3	50	0.024	9.00	0.60	2650	191	
			8.00	3	50	0.032	12.00	0.80	1980	190	
		Ti and Ti alloys Ti-Legierungen High temperature alloys Warmfeste Superlegierungen	10.00	3	50	0.038	15.00	1.00	1590	181	
			12.00	3	50	0.046	18.00	1.20	1320	182	
			16.00	3	50	0.054	24.00	1.60	990	160	
			20.00	3	50	0.066	30.00	2.00	790	156	
		Cast iron Guss	3.00	3	150	0.010	4.50	0.30	15910	477	
			4.00	3	150	0.015	6.00	0.40	11930	537	
			5.00	3	150	0.020	7.50	0.50	9540	572	
			6.00	3	150	0.024	9.00	0.60	7950	572	
			8.00	3	150	0.032	12.00	0.80	5960	572	
			10.00	3	150	0.038	15.00	1.00	4770	544	
			12.00	3	150	0.046	18.00	1.20	3970	548	
			16.00	3	150	0.054	24.00	1.60	2980	483	
			20.00	3	150	0.066	30.00	2.00	2380	471	
		Aluminum alloy Alu-Legierung Si<=10%	3.00	3	300	0.024	1.50	1.50	31830	2292	
			4.00	3	300	0.300	2.00	2.00	23870	21483	
			5.00	3	300	0.032	2.50	2.50	19090	1833	
			6.00	3	300	0.041	3.00	3.00	15910	1957	
			8.00	3	300	0.058	4.00	4.00	11930	2076	
			10.00	3	300	0.073	5.00	5.00	9540	2089	
			12.00	3	300	0.090	6.00	6.00	7950	2147	
			16.00	3	300	0.110	8.00	8.00	5960	1967	
			20.00	3	300	0.130	10.00	10.00	4770	1860	
		Brass Bronze Kupfer	3.00	3	150	0.024	1.50	1.50	15910	1146	
			4.00	3	150	0.300	2.00	2.00	11930	10737	
			5.00	3	150	0.032	2.50	2.50	9540	916	
			6.00	3	150	0.041	3.00	3.00	7950	978	
			8.00	3	150	0.058	4.00	4.00	5960	1037	
			10.00	3	150	0.073	5.00	5.00	4770	1045	
			12.00	3	150	0.090	6.00	6.00	3970	1072	
			16.00	3	150	0.110	8.00	8.00	2980	983	
			20.00	3	150	0.130	10.00	10.00	2380	928	

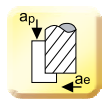

- Please start a test cutting with 85% of the Vc or 75% of the fz, then increase the cutting speed and feed rate.
- Please use high precision and high rigidity clamping system. The oscillation of the tool can not be over 0.01 mm.
- When $ap=1*d1$, $fz = 75%$ as the data in the table.
- Recommended operation: climb milling.

- Bitte führen Sie einen Testschnitt mit 85% der Vc und 75% des fz durch. Nach erfolgreichem Test können Sie die Schnittgeschwindigkeit bzw. die Vorschubwerte entsprechend erhöhen.
- Bitte verwenden Sie nur Spannmittel mit einer hohen Genauigkeit und einer hohen Spannkraft. Überprüfen Sie den Rundlauf der Werkzeuge. Sie sollten darauf achten, dass der Rundlauffehler nicht größer als 0,01 mm ist.
- Bei Fräsoperationen, die mit einer $ap=1*d1$ durchgeführt werden, ist fz um 25% zu reduzieren.
- Empfohlene Fräsmethode: Gleichlaufräsen.

B

Solid Carbide end mills
Vollhartmetallschaftfräser

Recommended cutting data · Empfohlene Schnittdaten

GM-3E | GM-3EL

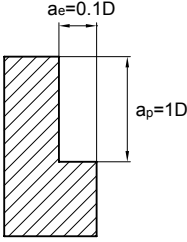
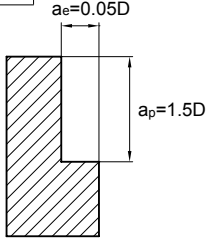
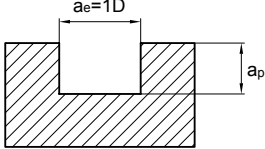
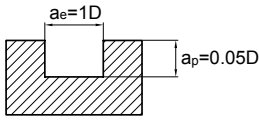
Workpiece material Werkstückmaterial	Cast iron, Nodular cast iron Grauguss GGG		Carbon steel, Alloy steel Kohlenstoffstahl Leg. Stahl ~750N/mm ²		Carbon steel, Alloy steel Kohlenstoffstahl Leg. Stahl ~30HRC		Pre-hardened steel, Quenched and tempered steel Vergüteter Stahl ~40HRC		Stainless steel Rostfreier Stahl		Pre-hardened steel, Quenched and tempered steel Vergüteter Stahl ~50HRC								
	Diameter Ø Durchmesser (mm)	Rotating Drehzahl (min ⁻¹)	Feed Vorschub (mm/min)	Rotating Drehzahl (min ⁻¹)	Feed Vorschub (mm/min)	Rotating Drehzahl (min ⁻¹)	Feed Vorschub (mm/min)	Rotating Drehzahl (min ⁻¹)	Feed Vorschub (mm/min)	Rotating Drehzahl (min ⁻¹)	Feed Vorschub (mm/min)	Rotating Drehzahl (min ⁻¹)	Feed Vorschub (mm/min)						
1	20000	215	20000	215	20000	175	20000	175	20000	65	20000	130							
2	15000	345	15000	345	15000	310	15000	305	11150	90	13000	195							
3	14000	590	14000	590	13000	546	10600	455	7500	130	8500	360							
4	10800	600	10800	605	10000	560	8000	460	5500	145	6500	365							
5	8200	630	8200	630	7600	585	6400	480	4500	145	5000	380							
6	7000	650	7000	650	6400	600	5300	500	3700	150	4200	390							
8	5200	645	5200	645	4800	590	4000	495	2800	150	3200	400							
10	4200	630	4200	630	3800	585	3200	480	2200	150	2500	380							
12	3500	630	3500	630	3200	585	2650	480	1850	150	2100	380							
14	3000	590	3000	590	2700	545	2300	455	1600	145	1800	360							
16	2600	590	2600	590	2400	545	2000	455	1400	130	1600	360							
18	2300	580	2300	580	2100	530	1800	450	1250	130	1400	350							
20	2050	580	2050	580	1900	530	1600	450	1100	130	1250	350							
Max. cutting depth max. Schnitttiefe																			
	 <table border="1" data-bbox="788 1397 1082 1532"> <thead> <tr> <th>Milling slot</th> <th>Nutenfräsen</th> </tr> <tr> <th>Ø</th> <th>Ap</th> </tr> </thead> <tbody> <tr> <td>Ø1 ≤ D < Ø3</td> <td>0.15D</td> </tr> <tr> <td>Ø3 ≤ D</td> <td>0.3D</td> </tr> </tbody> </table>						Milling slot	Nutenfräsen	Ø	Ap	Ø1 ≤ D < Ø3	0.15D	Ø3 ≤ D	0.3D					
Milling slot	Nutenfräsen																		
Ø	Ap																		
Ø1 ≤ D < Ø3	0.15D																		
Ø3 ≤ D	0.3D																		

- The above table shows the standard value of side milling. When slot milling, of rotating speed 50%~70% and feed rate like mentioned above 40%~60%.
- Please select high precise machine and tool holder.
- Please use air blow or cutting liquid with high mist retardant property.
- Down milling is recommended in side milling.
- Vibration and unusual noise may be generated if the machine rigidity and workpiece fixture stability is low, please reduce the rotating speed and feed rate like mentioned above.
- Make overhang as short as possible if no interference.

- Die obige Tabelle zeigt Standard Werte für das Eckfräsen. Bei Nutenfräsen, Schnittgeschwindigkeit auf 50-70% und den Vorschub auf 40-60% reduzieren.
- Bitte präzise Maschinen und Werkzeughalter verwenden.
- Bitte Luftkühlung oder Schneidflüssigkeit benutzen.
- Empfohlene Fräsmethode: Gleichlaufräsen.
- Bei Vibrationen oder unüblichen Geräuschen reduzieren Sie die Schnittdaten (wie oben empfohlen) entsprechend.
- Werkzeugauskragung so kurz wie möglich wählen.

Milling · Fräsen

Solid Carbide end mills · Vollhartmetallschaftfräser

GM-4E-G

4-flute flattened end mills with straight shank
4-Schneiden Eckfräser mit Zylinderschaft

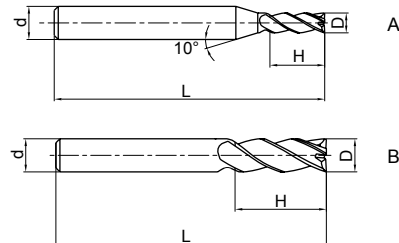

Type Typ	Dimension (mm) Abmessungen				Teeth Zähne Z	Geometry Ausführung	Grade Sorte KMG 303
	D	d	H	L			
GM-4E-D1.0S-G	1.0	4	3	50	4	A	●
GM-4E-D1.5S-G	1.5	4	4	50	4	A	●
GM-4E-D2.0S-G	2.0	4	6	50	4	A	●
GM-4E-D2.5S-G	2.5	4	8	50	4	A	●
GM-4E-D3.0S-G	3.0	4	8	50	4	A	●
GM-4E-D4.0S-G	4.0	4	11	50	4	B	●
GM-4E-D1.0-G	1.0	6	3	50	4	A	●
GM-4E-D1.5-G	1.5	6	4	50	4	A	●
GM-4E-D2.0-G	2.0	6	6	50	4	A	●
GM-4E-D2.5-G	2.5	6	8	50	4	A	●
GM-4E-D3.0-G	3.0	6	8	50	4	A	●
GM-4E-D3.5-G	3.5	6	10	50	4	A	●
GM-4E-D4.0-G	4.0	6	11	50	4	A	●
GM-4E-D4.5-G	4.5	6	11	50	4	A	○
GM-4E-D5.0-G	5.0	6	13	50	4	A	●
GM-4E-D5.5-G	5.5	6	16	50	4	A	●
GM-4E-D6.0-G	6.0	6	16	50	4	B	●
GM-4E-D7.0-G	7.0	8	20	60	4	A	●
GM-4E-D8.0-G	8.0	8	20	60	4	B	●
GM-4E-D9.0-G	9.0	10	22	75	4	A	●
GM-4E-D10.0-G	10.0	10	25	75	4	B	●
GM-4E-D11.0-G	11.0	12	26	75	4	A	●
GM-4E-D12.0-G	12.0	12	30	75	4	B	●
GM-4E-D14.0-G	14.0	14	32	75	4	B	●
GM-4E-D16.0-G	16.0	16	45	100	4	B	●
GM-4E-D18.0-G	18.0	18	45	100	4	B	●
GM-4E-D20.0-G	20.0	20	45	100	4	B	●

Material Overview · Material Übersicht

✓ = Very suitable · Sehr empfohlen
✓ = Suitable · Empfohlen

KMG303

Workpiece material Werkstückstoff											
Carbon steel Kohlenstoff Stahl	Alloy steel Legierter Stahl	Quenched and tempered steel · Vergüteter Stahl		Hardened steel · Gehärteter Stahl		Stainless steel · Rostfreier Stahl	Cast iron, Nodular cast iron Grauguss GGG	Copper alloy Kupfer Leg	Aluminum alloy Alu Leg	Titanium alloy Titan Leg	Heat resist alloy warmfeste Leg
		~40HRC	~50HRC	~55HRC	~68HRC						
✓	✓	✓	✓			✓	✓				

● Ex Stock / ab Lager ○ On demand / auf Anfrage

GM-4F-G

4-flute flattened end mills with straight shank
4-Schneiden Eckfräser mit Zylinderschaft

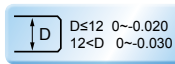
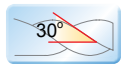
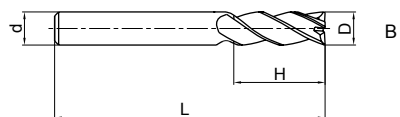
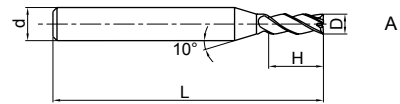
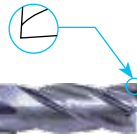

Type Typ	Dimension(mm) Abmessungen				Teeth Zähne Z	Geometry Ausführung	Grade Sorte KMG 303
	D	d	H	L			
GM-4F-D1.0S-G	1.0	4	3	50	4	A	○
GM-4F-D1.5S-G	1.5	4	4	50	4	A	○
GM-4F-D2.0S-G	2.0	4	6	50	4	A	○
GM-4F-D2.5S-G	2.5	4	8	50	4	A	○
GM-4F-D3.0S-G	3.0	4	8	50	4	A	○
GM-4F-D4.0S-G	4.0	4	11	50	4	B	○
GM-4F-D1.0-G	1.0	6	3	50	4	A	●
GM-4F-D1.5-G	1.5	6	4	50	4	A	○
GM-4F-D2.0-G	2.0	6	6	50	4	A	○
GM-4F-D2.5-G	2.5	6	8	50	4	A	○
GM-4F-D3.0-G	3.0	6	8	50	4	A	○
GM-4F-D3.5-G	3.5	6	10	50	4	A	○
GM-4F-D4.0-G	4.0	6	11	50	4	A	○
GM-4F-D4.5-G	4.5	6	11	50	4	A	○
GM-4F-D5.0-G	5.0	6	13	50	4	A	○
GM-4F-D5.5-G	5.5	6	16	50	4	A	○
GM-4F-D6.0-G	6.0	6	16	50	4	B	○
GM-4F-D7.0-G	7.0	8	20	60	4	A	○
GM-4F-D8.0-G	8.0	8	20	60	4	B	○
GM-4F-D9.0-G	9.0	10	22	75	4	A	○
GM-4F-D10.0-G	10.0	10	25	75	4	B	○
GM-4F-D11.0-G	11.0	12	26	75	4	A	○
GM-4F-D12.0-G	12.0	12	30	75	4	B	○
GM-4F-D14.0-G	14.0	14	32	75	4	B	○
GM-4F-D16.0-G	16.0	16	45	100	4	B	○
GM-4F-D18.0-G	18.0	18	45	100	4	B	○
GM-4F-D20.0-G	20.0	20	45	100	4	B	○

B

Solid Carbide end mills
Vollhartmetallschaftfräser

Material Overview · Material Übersicht

✓ = Very suitable · Sehr empfohlen
✓ = Suitable · Empfohlen

KMG303

Workpiece material Werkstückstoff											
Carbon steel Kohlenstoff Stahl	Alloy steel Legierter Stahl	Quenched and tempered steel · Vergüteter Stahl		Hardened steel · Gehärteter Stahl		Stainless steel · Rostfreier Stahl	Cast iron, Nodular cast iron Grauguss GGG	Copper alloy Kupfer Leg	Aluminum alloy Alu Leg	Titanium alloy Titan Leg	Heat resist alloy warmfeste Leg
		~40HRC	~50HRC	~55HRC	~68HRC						
✓	✓	✓	✓			✓	✓				

Code key B252-B254
ISO Kennzeichen

Cutting data B354-B361
Schnittdaten

Graphics identification & application B253-B255
Graphische Werkzeug- & Anwendungsbeschr.

Order form for non-standard products B534-B535
Bestellformular für Sonderwerkzeuge

Milling · Fräsen

Solid Carbide end mills · Vollhartmetallschaftfräser

GM-4EL-G

4-flute flattened end mills with straight shank and long cutting edge
4-Schneiden Eckfräser mit langer Schneide und Zylinderschaft

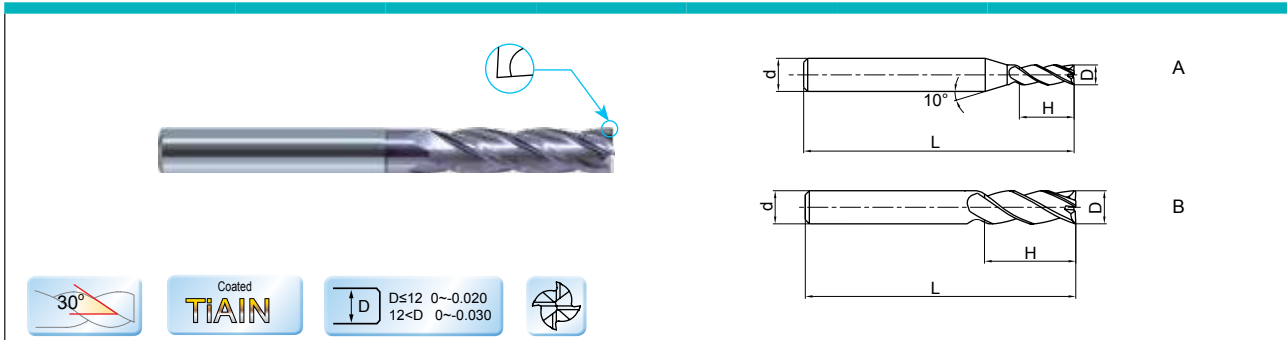

Type Typ	Dimension(mm) Abmessungen				Teeth Zähne Z	Geometry Ausführung	Grade Sorte KMG 303
	D	d	H	L			
GM-4EL-D3.0-G	3.0	6	12	75	4	A	○
GM-4EL-D4.0-G	4.0	6	15	75	4	A	○
GM-4EL-D5.0-G	5.0	6	20	75	4	A	○
GM-4EL-D6.0-G	6.0	6	20	75	4	B	○
GM-4EL-D8.0-G	8.0	8	25	100	4	B	○
GM-4EL-D10.0-G	10.0	10	30	100	4	B	○
GM-4EL-D12.0-G	12.0	12	35	100	4	B	○
GM-4EL-D14.0-G	14.0	14	40	100	4	B	○
GM-4EL-D16.0-G	16.0	16	50	150	4	B	○
GM-4EL-D20.0-G	20.0	20	55	150	4	B	○

B

Solid Carbide end mills
Vollhartmetallschaftfräser

Material Overview · Material Übersicht

✓ = Very suitable · Sehr empfohlen
✓ = Suitable · Empfohlen

KMG303

Workpiece material Werkstückstoff											
Carbon steel Kohlenstoff Stahl	Alloy steel Legierter Stahl	Quenched and tempered steel · Vergüteter Stahl		Hardened steel · Gehärteter Stahl		Stainless steel · Rostfreier Stahl	Cast iron, Nodular cast iron Grauguss GGG	Copper alloy Kupfer Leg	Aluminum alloy Alu Leg	Titanium alloy Titan Leg	Heat resist alloy warmfeste Leg
		~40HRC	~50HRC	~55HRC	~68HRC						
✓	✓	✓	✓			✓	✓				

● Ex Stock / ab Lager ○ On demand / auf Anfrage

GM-4FL-G

4-flute flattened end mills with straight shank and long cutting edge
4-Schneiden Eckfräser mit langer Schneide und Zylinderschaft

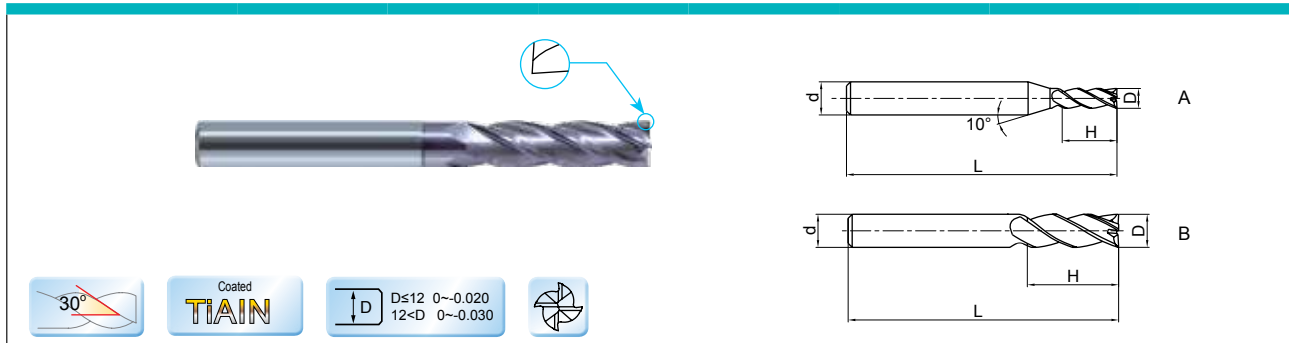

Type Typ	Dimension(mm) Abmessungen				Teeth Zähne Z	Geometry Ausführung	Grade Sorte KMG 303
	D	d	H	L			
GM-4FL-D3.0-G	3.0	6	12	75	4	A	○
GM-4FL-D4.0-G	4.0	6	15	75	4	A	○
GM-4FL-D5.0-G	5.0	6	20	75	4	A	●
GM-4FL-D6.0-G	6.0	6	20	75	4	B	●
GM-4FL-D8.0-G	8.0	8	25	100	4	B	●
GM-4FL-D10.0-G	10.0	10	30	100	4	B	●
GM-4FL-D12.0-G	12.0	12	35	100	4	B	●
GM-4FL-D14.0-G	14.0	14	40	100	4	B	○
GM-4FL-D16.0-G	16.0	16	50	150	4	B	○
GM-4FL-D20.0-G	20.0	20	55	150	4	B	●

B

Solid Carbide end mills
Vollhartmetallschaftfräser

Material Overview · Material Übersicht

✓ = Very suitable · Sehr empfohlen
✓ = Suitable · Empfohlen

KMG303

Workpiece material Werkstückstoff											
Carbon steel Kohlenstoff Stahl	Alloy steel Legierter Stahl	Quenched and tempered steel · Vergüteter Stahl		Hardened steel · Gehärteter Stahl		Stainless steel · Rostfreier Stahl	Cast iron, Nodular cast iron Grauguss GGG	Copper alloy Kupfer Leg	Aluminum alloy Alu Leg	Titanium alloy Titan Leg	Heat resist alloy warmfeste Leg
		~40HRC	~50HRC	~55HRC	~68HRC						
✓	✓	✓	✓			✓	✓				

Code key B252,B254
ISO Kennzeichen

Cutting data B354-B361
Schnittdaten

Graphics identification & application B253-B255
Graphische Werkzeug- & Anwendungsbeschr.

Order form for non-standard products B534-B535
Bestellformular für Sonderwerkzeuge

Milling · Fräsen

Solid Carbide end mills · Vollhartmetallschaftfräser

GM-4EX-G

4-flute flattened end mills with straight shank and extra long cutting edge
4-Schneiden Eckfräser mit extra langer Schneide und Zylinderschaft

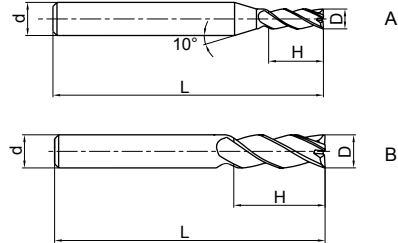

Type Typ	Dimension (mm) Abmessungen				Teeth Zähne Z	Geometry Ausführung	Grade Sorte KMG 303
	D	d	H	L			
GM-4EX-D3.0-G	3.0	6	20	75	4	A	●
GM-4EX-D4.0-G	4.0	6	25	75	4	A	●
GM-4EX-D5.0-G	5.0	6	30	75	4	A	●
GM-4EX-D6.0-G	6.0	6	30	75	4	B	●
GM-4EX-D8.0-G	8.0	8	40	100	4	B	●
GM-4EX-D10.0-G	10.0	10	50	110	4	B	●
GM-4EX-D12.0-G	12.0	12	50	110	4	B	●
GM-4EX-D16.0-G	16.0	16	70	150	4	B	●
GM-4EX-D20.0-G	20.0	20	75	150	4	B	●

B

Solid Carbide end mills
Vollhartmetallschaftfräser

Material Overview · Material Übersicht

✓ = Very suitable · Sehr empfohlen
✓ = Suitable · Empfohlen

KMG303

Workpiece material Werkstückstoff											
Carbon steel Kohlenstoff Stahl	Alloy steel Legierter Stahl	Quenched and tempered steel · Vergüteter Stahl		Hardened steel · Gehärteter Stahl		Stainless steel · Rostfreier Stahl	Cast iron, Nodular cast iron Grauguss GGG	Copper alloy Kupfer Leg	Aluminum alloy Alu Leg	Titanium alloy Titan Leg	Heat resist alloy warmfeste Leg
		~40HRC	~50HRC	~55HRC	~68HRC						
✓	✓	✓	✓			✓	✓				

● Ex Stock / ab Lager ○ On demand / auf Anfrage

GM-4E series for general machining · **GM-4E** Serie für allgemeine Bearbeitung

4-flute flattened end mills with straight shank
4-Schneiden Eckfräser mit Zylinderschaft

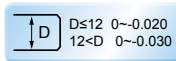
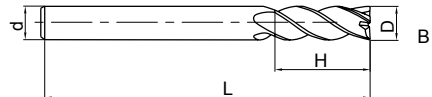
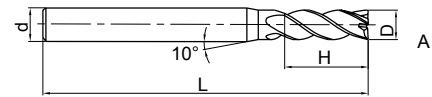
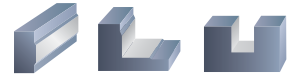

Type Typ	Dimension(mm) Abmessungen				Teeth Zähne Z	Geometry Ausführung	Grade Sorte KMG 303
	D	d	H	L			
GM-4E-D1.0S	1.0	4	3	50	4	A	●
GM-4E-D1.5S	1.5	4	4	50	4	A	●
GM-4E-D2.0S	2.0	4	6	50	4	A	●
GM-4E-D2.5S	2.5	4	8	50	4	A	●
GM-4E-D3.0S	3.0	4	8	50	4	A	●
GM-4E-D4.0S	4.0	4	11	50	4	B	●
GM-4E-D1.0	1.0	6	3	50	4	A	●
GM-4E-D1.5	1.5	6	4	50	4	A	●
GM-4E-D2.0	2.0	6	6	50	4	A	●
GM-4E-D2.5	2.5	6	8	50	4	A	●
GM-4E-D3.0	3.0	6	8	50	4	A	●
GM-4E-D3.5	3.5	6	10	50	4	A	●
GM-4E-D4.0	4.0	6	11	50	4	A	●
GM-4E-D4.5	4.5	6	11	50	4	A	●
GM-4E-D5.0	5.0	6	13	50	4	A	●
GM-4E-D5.5	5.5	6	16	50	4	A	●
GM-4E-D6.0	6.0	6	16	50	4	B	●
GM-4E-D7.0	7.0	8	20	60	4	A	●
GM-4E-D8.0	8.0	8	20	60	4	B	●
GM-4E-D9.0	9.0	10	22	75	4	A	●
GM-4E-D10.0	10.0	10	25	75	4	B	●
GM-4E-D11.0	11.0	12	26	75	4	A	●
GM-4E-D12.0	12.0	12	30	75	4	B	●
GM-4E-D14.0	14.0	14	32	75	4	B	●
GM-4E-D16.0	16.0	16	45	100	4	B	●
GM-4E-D18.0	18.0	18	45	100	4	B	●
GM-4E-D20.0	20.0	20	45	100	4	B	●

✓ = Very suitable · Sehr empfohlen
✓ = Suitable · Empfohlen

Material Overview · Material Übersicht

KMG303

Workpiece material Werkstückstoff											
Carbon steel Kohlenstoff Stahl	Alloy steel Legierter Stahl	Quenched and tempered steel · Vergüteter Stahl		Hardened steel · Gehärteter Stahl		Stainless steel · Rostfreier Stahl	Cast iron, Nodular cast iron Grauguss GGG	Copper alloy Kupfer Leg	Aluminum alloy Alu Leg	Titanium alloy Titan Leg	Heat resist alloy warmfeste Leg
		~40HRC	~50HRC	~55HRC	~68HRC						
✓	✓	✓	✓			✓	✓				

Code key B252-B254
ISO Kennzeichen

Cutting data B354-B361
Schnittdaten

Graphics identification & application B253-B255
Graphische Werkzeug- & Anwendungsbeschr.

Order form for non-standard products B534-B535
Bestellformular für Sonderwerkzeuge

Milling · Fräsen

Solid Carbide end mills · Vollhartmetallschaftfräser

GM-4EL series for general machining · GM-4EL Serie für allgemeine Bearbeitung

4-flute flattened end mills with straight shank and long cutting edge
4-Schneiden Eckfräser mit langer Schneide und Zylinderschaft

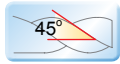
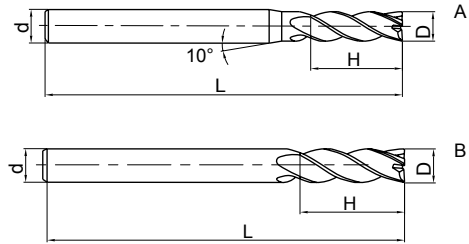

Type Typ	Dimension (mm) Abmessungen				Teeth Zähne Z	Geometry Ausführung	Grade Sorte KMG 303
	D	d	H	L			
GM-4EL-D3.0	3.0	6	12	75	4	A	●
GM-4EL-D4.0	4.0	6	15	75	4	A	●
GM-4EL-D5.0	5.0	6	20	75	4	A	●
GM-4EL-D6.0	6.0	6	20	75	4	B	●
GM-4EL-D8.0	8.0	8	25	100	4	B	●
GM-4EL-D10.0	10.0	10	30	100	4	B	●
GM-4EL-D12.0	12.0	12	35	100	4	B	●
GM-4EL-D14.0	14.0	14	40	100	4	B	●
GM-4EL-D16.0	16.0	16	50	150	4	B	●
GM-4EL-D20.0	20.0	20	55	150	4	B	●

B

Solid Carbide end mills
Vollhartmetallschaftfräser

Material Overview · Material Übersicht

✓ = Very suitable · Sehr empfohlen
✓ = Suitable · Empfohlen

KMG303

Workpiece material Werkstückstoff											
Carbon steel Kohlenstoff Stahl	Alloy steel Legierter Stahl	Quenched and tempered steel · Vergüteter Stahl		Hardened steel · Gehärteter Stahl		Stainless steel · Rostfreier Stahl	Cast iron, Nodular cast iron Grauguss GGG	Copper alloy Kupfer Leg	Aluminum alloy Alu Leg	Titanium alloy Titan Leg	Heat resist alloy warmfeste Leg
		~40HRC	~50HRC	~55HRC	~68HRC						
✓	✓	✓	✓			✓	✓				

● Ex Stock / ab Lager ○ On demand / auf Anfrage

GM-4EFP

4-flute end mills with straight shank and short cutting edge and long neck
4-Schneiden Eckfräser mit kurzer Schneide und Zylinderschaft

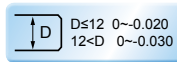
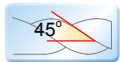
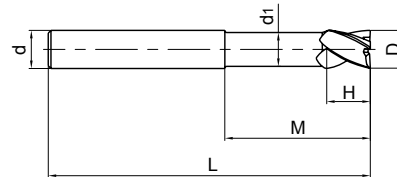

Type Typ	Dimension(mm) Abmessungen						Teeth Zähne Z	Grade Sorte KMG 303
	D	d	H	M	d ₁	L		
GM-4EFP-D6.0	6.0	6	9	30	5.8	75	4	○
GM-4EFP-D8.0	8.0	8	12	40	7.8	100	4	○
GM-4EFP-D10.0	10.0	10	15	50	9.6	100	4	○
GM-4EFP-D12.0	12.0	12	18	50	11.5	100	4	○
GM-4EFP-D16.0	16.0	16	24	50	15.5	150	4	○
GM-4EFP-D20.0	20.0	20	30	60	19.5	150	4	○

B

Solid Carbide end mills
Vollhartmetallschaftfräser

Material Overview · Material Übersicht

✓ = Very suitable · Sehr empfohlen
✓ = Suitable · Empfohlen

KMG303

Workpiece material Werkstückstoff											
Carbon steel Kohlenstoff Stahl	Alloy steel Legierter Stahl	Quenched and tempered steel · Vergüteter Stahl		Hardened steel · Gehärteter Stahl		Stainless steel · Rostfreier Stahl	Cast iron, Nodular cast iron Grauguss GGG	Copper alloy Kupfer Leg	Aluminum alloy Alu Leg	Titanium alloy Titan Leg	Heat resist alloy warmfeste Leg
		~40HRC	~50HRC	~55HRC	~68HRC						
✓	✓	✓	✓			✓	✓				

Code key B252,B254
ISO Kennzeichen

Cutting data B354-B361
Schnittdaten

Graphics identification & application B253-B255
Graphische Werkzeug- & Anwendungsbeschr.

Order form for non-standard products B534-B535
Bestellformular für Sonderwerkzeuge

B347

Milling · Fräsen

Solid Carbide end mills · Vollhartmetallschaftfräser

DIN 6527K 4-flute end mills · DIN 6527K 4-Schneiden VHM Schaftfräser

5501R304GF

YK30F: Ultra-fine carbide grade / Ultrafeinkornhartmetall

KMG303: nano AlTiN Coated Ultra-fine Carbide / nano AlTiN beschichtetes Ultrafeinkornhartmetall

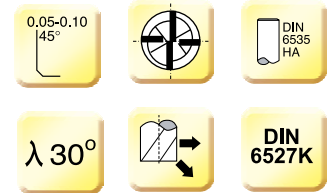
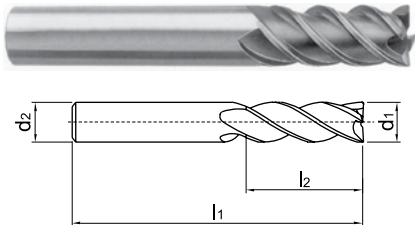

B

Solid Carbide end mills
Vollhartmetallschaftfräser

Type Typ	Dimension(mm) Abmessungen				Teeth Zähne	Application Anwendung	P M K	
	d1(e8)	d2(h6)	l2	l1			Grade Sorte	YK30F
5501R304GF-0300	3.00	6	5	50	4		○	●
5501R304GF-0400	4.00	6	8	54	4		○	●
5501R304GF-0500	5.00	6	9	54	4		○	●
5501R304GF-0600	6.00	6	10	54	4		○	●
5501R304GF-0800	8.00	8	12	58	4		○	●
5501R304GF-1000	10.00	10	14	66	4		○	●
5501R304GF-1200	12.00	12	16	73	4		○	●
5501R304GF-1400	14.00	14	18	75	4		○	●
5501R304GF-1600	16.00	16	22	82	4		○	●
5501R304GF-1800	18.00	18	24	84	4		○	●
5501R304GF-2000	20.00	20	26	92	4		○	●
Art. Group No. / Produktgruppe Nr. :							021140	021130

Material Overview · Material Übersicht

✓ = Very suitable · Sehr empfohlen
✓ = Suitable · Empfohlen

KMG303

Workpiece material Werkstückstoff											
Carbon steel Kohlenstoff Stahl	Alloy steel Legierter Stahl	Quenched and tempered steel · Vergüteter Stahl		Hardened steel · Gehärteter Stahl		Stainless steel · Rostfreier Stahl	Cast iron, Nodular cast iron Grauguss GGG	Copper alloy Kupfer Leg	Aluminum alloy Alu Leg	Titanium alloy Titan Leg	Heat resist alloy warmfeste Leg
		~40HRC	~50HRC	~55HRC	~68HRC						
✓	✓	✓	✓			✓	✓				

● Ex Stock / ab Lager ○ On demand / auf Anfrage

DIN 6527K 4-flute end mills · DIN 6527K 4-Schneiden VHM Schafffräser

5601R304GF

YK30F: Ultra-fine carbide grade / *Ultrafeinkornhartmetall*
 KMG303: nano AlTiN Coated Ultra-fine Carbide / *nano AlTiN beschichtetes Ultrafeinkornhartmetall*

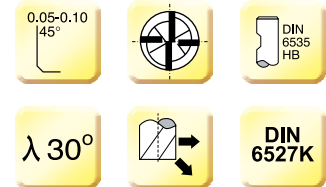
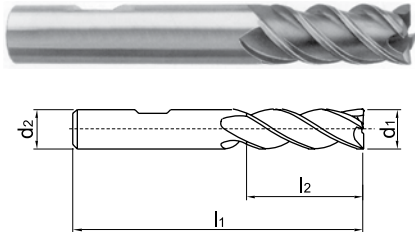

Type Typ	Dimension(mm) Abmessungen				Teeth Zähne	Application Anwendung	P M K	
	d1(e8)	d2(h6)	l2	l1			Grade Sorte	YK30F
5601R304GF-0300	3.00	6	5	50	4		○	●
5601R304GF-0400	4.00	6	8	54	4		○	●
5601R304GF-0500	5.00	6	9	54	4		○	●
5601R304GF-0600	6.00	6	10	54	4		○	●
5601R304GF-0800	8.00	8	12	58	4		○	●
5601R304GF-1000	10.00	10	14	66	4		○	●
5601R304GF-1200	12.00	12	16	73	4		●	●
5601R304GF1400	14.00	14	18	75	4		○	●
5601R304GF-1600	16.00	16	22	82	4		○	●
5601R304GF-1800	18.00	18	24	84	4		○	●
5601R304GF-2000	20.00	20	26	92	4		○	●
Art. Group No. / Produktgruppe Nr. :							021140	021130

B

Solid Carbide end mills
Vollhartmetallschaftfräser

Material Overview · Material Übersicht

✓ = Very suitable · Sehr empfohlen
 ✓ = Suitable · Empfohlen

KMG303

Workpiece material Werkstückstoff											
Carbon steel Kohlenstoff Stahl	Alloy steel Legierter Stahl	Quenched and tempered steel · Vergüteter Stahl		Hardened steel · Gehärteter Stahl		Stainless steel · Rostfreier Stahl	Cast iron, Nodular cast iron Grauguss GGG	Copper alloy Kupfer Leg	Aluminum alloy Alu Leg	Titanium alloy Titan Leg	Heat resist alloy warmfeste Leg
		~40HRC	~50HRC	~55HRC	~68HRC						
✓	✓	✓	✓			✓	✓				

Code key B252,B254
ISO Kennzeichen

Cutting data B354-B361
Schnittdaten

Graphics identification & application B253-B255
Graphische Werkzeug- & Anwendungsbeschr.

Order form for non-standard products B534-B535
Bestellformular für Sonderwerkzeuge

Milling · Fräsen

Solid Carbide end mills · Vollhartmetallschaftfräser

DIN 6527L 4-flute end mills · DIN 6527L 4-Schneiden VHM Schaftfräser

5502R304GF

YK30F: Ultra-fine carbide grade / Ultrafeinkornhartmetall

KMG303: nano AlTiN Coated Ultra-fine Carbide / nano AlTiN beschichtetes Ultrafeinkornhartmetall

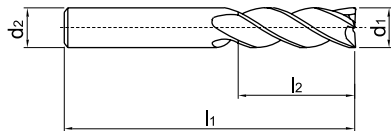

Type Typ	Dimension(mm) Abmessungen				Teeth Zähne	Application Anwendung	P M K	
	d1(e8)	d2(h6)	l2	l1			Grade Sorte	YK30F
5502R304GF-0300	3.00	6	8	57	4		○	●
5502R304GF-0400	4.00	6	11	57	4		○	●
5502R304GF-0500	5.00	6	13	57	4		○	●
5502R304GF-0600	6.00	6	13	57	4		○	●
5502R304GF-0800	8.00	8	19	63	4		○	●
5502R304GF-1000	10.00	10	22	72	4		○	●
5502R304GF-1200	12.00	12	26	83	4		○	●
5502R304GF-1400	14.00	14	26	83	4		○	●
5502R304GF-1600	16.00	16	32	92	4		○	●
5502R304GF-1800	18.00	18	32	92	4		○	●
5502R304GF-2000	20.00	20	38	104	4		○	●
Art. Group No. / Produktgruppe Nr. :							021140	021130

B

Solid Carbide end mills
Vollhartmetallschaftfräser

Material Overview · Material Übersicht

✓ = Very suitable · Sehr empfohlen

✓ = Suitable · Empfohlen

KMG303

Workpiece material Werkstückstoff											
Carbon steel Kohlenstoff Stahl	Alloy steel Legierter Stahl	Quenched and tempered steel · Vergüteter Stahl		Hardened steel · Gehärteter Stahl		Stainless steel · Rostfreier Stahl	Cast iron, Nodular cast iron Grauguss GGG	Copper alloy Kupfer Leg	Aluminum alloy Alu Leg	Titanium alloy Titan Leg	Heat resist alloy warmfeste Leg
		~40HRC	~50HRC	~55HRC	~68HRC						
✓	✓	✓	✓			✓	✓				

● Ex Stock / ab Lager ○ On demand / auf Anfrage

DIN 6527L 4-flute end mills · DIN 6527L 4-Schneiden VHM Schafffräser

5602R304GF

YK30F: Ultra-fine carbide grade / Ultrafeinkornhartmetall

KMG303: nano AlTiN Coated Ultra-fine Carbide / nano AlTiN beschichtetes Ultrafeinkornhartmetall

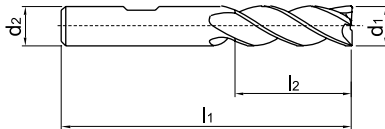

Type Typ	Dimension(mm) Abmessungen				Teeth Zähne	Application Anwendung	P M K	
	d1(e8)	d2(h6)	l2	l1			z	Grade Sorte
5602R304GF-0300	3.00	6	8	57	4		○	●
5602R304GF-0400	4.00	6	11	57	4		○	●
5602R304GF-0500	5.00	6	13	57	4		○	●
5602R304GF-0600	6.00	6	13	57	4		○	●
5602R304GF-0800	8.00	8	19	63	4		○	●
5602R304GF-1000	10.00	10	22	72	4		○	●
5602R304GF-1200	12.00	12	26	83	4		○	●
5602R304GF-1400	14.00	14	26	83	4		○	●
5602R304GF-1600	16.00	16	32	92	4		○	●
5602R304GF-1800	18.00	18	32	92	4		○	●
5602R304GF-2000	20.00	20	38	104	4		○	●
Art. Group No. / Produktgruppe Nr. :							021140	021130

B

Solid Carbide end mills
Vollhartmetallschafffräser

Material Overview · Material Übersicht

✓ = Very suitable · Sehr empfohlen
✓ = Suitable · Empfohlen

KMG303

Workpiece material Werkstückstoff											
Carbon steel Kohlenstoff Stahl	Alloy steel Legierter Stahl	Quenched and tempered steel · Vergüteter Stahl		Hardened steel · Gehärteter Stahl		Stainless steel · Rostfreier Stahl	Cast iron, Nodular cast iron Grauguss GGG	Copper alloy Kupfer Leg	Aluminum alloy Alu Leg	Titanium alloy Titan Leg	Heat resist alloy warmfeste Leg
		~40HRC	~50HRC	~55HRC	~68HRC						
✓	✓	✓	✓			✓	✓				

Code key **B252-B254**
ISO Kennzeichen

Cutting data **B354-B361**
Schnittdaten

Graphics identification & application **B253-B255**
Graphische Werkzeug- & Anwendungsbeschr.

Order form for non-standard products **B534-B535**
Bestellformular für Sonderwerkzeuge

Milling · Fräsen

Solid Carbide end mills · Vollhartmetallschaftfräser

DIN 6528 4-flute end mills · DIN 6528 4-Schneiden VHM Schaftfräser

5508R454GM

YK30F: Ultra-fine carbide grade / Ultrafeinkornhartmetall

KMG303: nano AlTiN Coated Ultra-fine Carbide / nano AlTiN beschichtetes Ultrafeinkornhartmetall

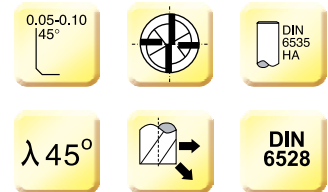
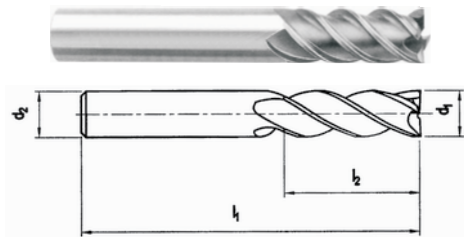
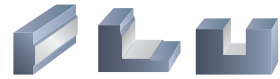

B

Solid Carbide end mills
Vollhartmetallschaftfräser

Type Typ	Dimension(mm) Abmessungen				Teeth Zähne	Application Anwendung	P M K	
	d1(e8)	d2(h6)	l2	l1			Grade Sorte	YK30F
5508R454GM-0300	3.00	3	8	45	4		○	●
5508R454GM-0400	4.00	4	11	50	4		○	●
5508R454GM-0500	5.00	5	13	50	4		○	●
5508R454GM-0600	6.00	6	13	57	4		○	●
5508R454GM-0800	8.00	8	19	63	4		○	●
5508R454GM-1000	10.00	10	22	72	4		○	●
5508R454GM-1200	12.00	12	26	83	4		○	●
5508R454GM-1400	14.00	14	26	83	4		○	●
5508R454GM-1600	16.00	16	32	92	4		○	●
5508R454GM-1800	18.00	18	32	92	4		○	●
5508R454GM-2000	20.00	20	38	104	4		○	●
Art. Group No. / Produktgruppe Nr. :							021140	021130

Material Overview · Material Übersicht

✓ = Very suitable · Sehr empfohlen

✓ = Suitable · Empfohlen

KMG303	Workpiece material Werkstückstoff											
	Carbon steel Kohlenstoff Stahl	Alloy steel Legierter Stahl	Quenched and tempered steel · Vergüteter Stahl		Hardened steel · Gehärteter Stahl		Stainless steel · Rostfreier Stahl	Cast iron, Nodular cast iron Grauguss GGG	Copper alloy Kupfer Leg	Aluminum alloy Alu Leg	Titanium alloy Titan Leg	Heat resist alloy warmfeste Leg
			~40HRC	~50HRC	~55HRC	~68HRC						
✓	✓	✓	✓				✓	✓				

● Ex Stock / ab Lager ○ On demand / auf Anfrage

DIN 6527L 4-flute end mills · DIN 6527L 4-Schneiden VHM Schafffräser

5602R454GM

YK30F: Ultra-fine carbide grade / *Ultrafeinkornhartmetall*

KMG303: nano AlTiN Coated Ultra-fine Carbide / *nano AlTiN beschichtetes Ultrafeinkornhartmetall*

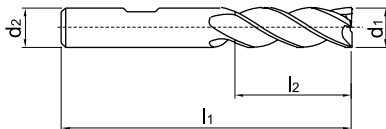
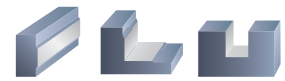

Type Typ	Dimension(mm) Abmessungen				Teeth Zähne	Application Anwendung	P M K		
	d1(e8)	d2(h6)	l2	l1			Grade Sorte	KMG303	
5602R454GM-0300	3.00	6	8	57	4			•	
5602R454GM-0400	4.00	6	11	57	4			•	
5602R454GM-0500	5.00	6	13	57	4			•	
5602R454GM-0600	6.00	6	13	57	4			•	
5602R454GM-0800	8.00	8	19	63	4			•	
5602R454GM-1000	10.00	10	22	72	4			•	
5602R454GM-1200	12.00	12	26	83	4			•	
5602R454GM-1400	14.00	14	26	83	4			•	
5602R454GM-1600	16.00	16	32	92	4			•	
5602R454GM-1800	18.00	18	32	92	4			•	
5602R454GM-2000	20.00	20	38	104	4			•	
Art. Group No. / Produktgruppe Nr. :							021130		

B

Solid Carbide end mills
Vollhartmetallschaftfräser

Material Overview · Material Übersicht

✓ = Very suitable · Sehr empfohlen
✓ = Suitable · Empfohlen

KMG303

Workpiece material Werkstückstoff											
Carbon steel Kohlenstoff Stahl	Alloy steel Legierter Stahl	Quenched and tempered steel · Vergüteter Stahl		Hardened steel · Gehärteter Stahl		Stainless steel · Rostfreier Stahl	Cast iron, Nodular cast iron Grauguss GGG	Copper alloy Kupfer Leg	Aluminum alloy Alu Leg	Titanium alloy Titan Leg	Heat resist alloy warmfeste Leg
		~40HRC	~50HRC	~55HRC	~68HRC						
✓	✓	✓	✓			✓	✓				

Code key **B252-B254**
ISO Kennzeichen

Cutting data **B354-B361**
Schnittdaten

Graphics identification & application **B253-B255**
Graphische Werkzeug- & Anwendungsbeschr.

Order form for non-standard products **B534-B535**
Bestellformular für Sonderwerkzeuge

Milling - Fräsen

Solid Carbide end mills - Vollhartmetallschaftfräser

Recommended cutting data - Empfohlene Schnittdaten

Type Typ	Grade Sorte	Material Werkstoffe	d ₁ (mm)	z	V _c (m/min)	f _z (mm/z)	a _p (mm)	a _e (mm)	n (min ⁻¹)	V _f (mm/min)	
5501R304GF	KMG303	Steel Stahl HRC<25	3.00	4	160	0.010	3.00	0.30	16970	679	
5601R304GF	KMG303		4.00	4	160	0.015	4.00	0.40	12730	764	
			5.00	4	160	0.020	5.00	0.50	10180	814	
			6.00	4	160	0.024	6.00	0.60	8480	814	
			8.00	4	160	0.032	8.00	0.80	6360	814	
			10.00	4	160	0.038	10.00	1.00	5090	774	
			12.00	4	160	0.046	12.00	1.20	4240	780	
			16.00	4	160	0.054	16.00	1.60	3180	687	
			20.00	4	160	0.066	20.00	2.00	2540	671	
			Steel, Steel alloy Stahl, legierter Stahl HRC=25-38	3.00	4	110	0.010	3.00	0.30	11670	467
				4.00	4	110	0.015	4.00	0.40	8750	525
				5.00	4	110	0.020	5.00	0.50	7000	560
				6.00	4	110	0.024	6.00	0.60	5830	560
				8.00	4	110	0.032	8.00	0.80	4370	559
		10.00		4	110	0.038	10.00	1.00	3500	532	
		12.00		4	110	0.046	12.00	1.20	2910	535	
		16.00		4	110	0.054	16.00	1.60	2180	471	
		20.00	4	110	0.066	20.00	2.00	1750	462		
		High ally steel Hochlegierter Stahl	3.00	4	70	0.010	3.00	0.30	7420	297	
			4.00	4	70	0.015	4.00	0.40	5570	334	
			5.00	4	70	0.020	5.00	0.50	4450	356	
			6.00	4	70	0.024	6.00	0.60	3710	356	
		Stainless steel Rostfreier Stahl	8.00	4	70	0.032	8.00	0.80	2780	356	
			10.00	4	70	0.038	10.00	1.00	2220	337	
			12.00	4	70	0.046	12.00	1.20	1850	340	
			16.00	4	70	0.054	16.00	1.60	1390	300	
		20.00	4	70	0.066	20.00	2.00	1110	293		
		Cast iron Guss	3.00	4	130	0.010	3.00	0.30	13790	552	
			4.00	4	130	0.015	4.00	0.40	10340	620	
			5.00	4	130	0.020	5.00	0.50	8270	662	
			6.00	4	130	0.024	6.00	0.60	6890	661	
			8.00	4	130	0.032	8.00	0.80	5170	662	
			10.00	4	130	0.038	10.00	1.00	4130	628	
		Ti and Ti alloys Ti-Legierungen	12.00	4	130	0.046	12.00	1.20	3440	633	
			16.00	4	130	0.054	16.00	1.60	2580	557	
			20.00	4	130	0.066	20.00	2.00	2060	544	
			3.00	4	80	0.010	3.00	0.30	8480	339	
			4.00	4	80	0.015	4.00	0.40	6360	382	
			5.00	4	80	0.020	5.00	0.50	5090	407	
			6.00	4	80	0.024	6.00	0.60	4240	407	
			8.00	4	80	0.032	8.00	0.80	3180	407	
		Ni-High temperature alloys Ni-Warmfeste Superlegierungen	10.00	4	80	0.038	10.00	1.00	2540	386	
			12.00	4	80	0.046	12.00	1.20	2120	390	
			16.00	4	80	0.054	16.00	1.60	1590	343	
			20.00	4	80	0.066	20.00	2.00	1270	335	
			3.00	4	40	0.010	3.00	0.30	4240	170	
			4.00	4	40	0.015	4.00	0.40	3180	191	
			5.00	4	40	0.020	5.00	0.50	2540	203	
			6.00	4	40	0.024	6.00	0.60	2120	204	
			8.00	4	40	0.032	8.00	0.80	1590	204	
			10.00	4	40	0.038	10.00	1.00	1270	193	
		12.00	4	40	0.046	12.00	1.20	1060	195		
		16.00	4	40	0.054	16.00	1.60	790	171		
		20.00	4	40	0.066	20.00	2.00	630	166		



- Please start a test cutting with 85% of the V_c or 75% of the f_z, then increase the cutting speed and feed rate.
- Please use high precision and high rigidity clamping system. The oscillation of the tool can not be over 0.01 mm.
- When a_p=1*d₁, f_z = 75% as the data in the table.
- Recommended operation: climb milling.

- Bitte führen Sie einen Testschnitt mit 85% der V_c und 75% des f_z durch. Nach erfolgtem Test können Sie die Schnittgeschwindigkeit bzw. die Vorschubwerte entsprechend erhöhen.
- Bitte verwenden Sie nur Spannmittel mit einer hohen Genauigkeit und einer hohen Spannkraft. Überprüfen Sie den Rundlauf der Werkzeuge. Sie sollten darauf achten, dass der Rundlauffehler nicht größer als 0.01 mm ist.
- Bei Fräsoperationen, die mit einer a_p=1*d₁ durchgeführt werden, ist f_z um 25% zu reduzieren.
- Empfohlene Fräsmethode: Gleichlaufräsen.

Recommended cutting data · Empfohlene Schnittdaten

Type Typ	Grade Sorte	Material Werkstoffe	d ₁ (mm)	z	V _c (m/min)	f _z (mm/z)	a _p (mm)	a _e (mm)	n (min ⁻¹)	V _f (mm/min)
5508R454GM	KMG303	Steel Stahl HRC<25	3.00	3	120	0.010	1.50	0.75	12730	382
5602R454GM	KMG303		4.00	3	120	0.015	2.00	1.00	9540	429
			5.00	3	120	0.020	2.50	1.25	7630	458
			6.00	3	120	0.024	3.00	1.50	6360	458
			8.00	3	120	0.032	4.00	2.00	4770	458
			10.00	3	120	0.038	5.00	2.50	3810	434
			12.00	3	120	0.046	6.00	3.00	3180	439
			16.00	3	120	0.054	8.00	4.00	2380	386
			20.00	3	120	0.066	10.00	5.00	1900	376
			3.00	3	90	0.010	1.50	0.75	9540	286
			4.00	3	90	0.015	2.00	1.00	7160	322
			5.00	3	90	0.020	2.50	1.25	5720	343
			6.00	3	90	0.024	3.00	1.50	4770	343
			8.00	3	90	0.032	4.00	2.00	3580	344
			10.00	3	90	0.038	5.00	2.50	2860	326
			12.00	3	90	0.046	6.00	3.00	2380	328
		16.00	3	90	0.054	8.00	4.00	1790	290	
		20.00	3	90	0.066	10.00	5.00	1430	283	
		3.00	3	40	0.010	1.50	0.75	4240	127	
		4.00	3	40	0.015	2.00	1.00	3180	143	
		5.00	3	40	0.020	2.50	1.25	2540	152	
		6.00	3	40	0.024	3.00	1.50	2120	153	
		8.00	3	40	0.032	4.00	2.00	1590	153	
		10.00	3	40	0.038	5.00	2.50	1270	145	
		12.00	3	40	0.046	6.00	3.00	1060	146	
		16.00	3	40	0.054	8.00	4.00	790	128	
		20.00	3	40	0.066	10.00	5.00	630	125	
		3.00	3	150	0.010	1.50	0.75	15910	477	
		4.00	3	150	0.015	2.00	1.00	11930	537	
		5.00	3	150	0.022	2.50	1.25	9540	630	
		6.00	3	150	0.027	3.00	1.50	7950	644	
		8.00	3	150	0.035	4.00	2.00	5960	626	
		10.00	3	150	0.044	5.00	2.50	4770	630	
		12.00	3	150	0.052	6.00	3.00	3970	619	
		16.00	3	150	0.063	8.00	4.00	2980	563	
		20.00	3	150	0.080	10.00	5.00	2380	571	
		3.00	3	300	0.015	1.50	0.75	31830	1432	
		4.00	3	300	0.020	2.00	1.00	23870	1432	
		5.00	3	300	0.025	2.50	1.25	19090	1432	
		6.00	3	300	0.029	3.00	1.50	15910	1384	
		8.00	3	300	0.042	4.00	2.00	11930	1503	
		10.00	3	300	0.050	5.00	2.50	9540	1431	
		12.00	3	300	0.059	6.00	3.00	7950	1407	
		16.00	3	300	0.072	8.00	4.00	5960	1287	
		20.00	3	300	0.090	10.00	5.00	4770	1288	
		3.00	3	150	0.015	1.50	0.75	15910	716	
		4.00	3	150	0.020	2.00	1.00	11930	716	
		5.00	3	150	0.025	2.50	1.25	9540	716	
		6.00	3	150	0.029	3.00	1.50	7950	692	
		8.00	3	150	0.042	4.00	2.00	5960	751	
		10.00	3	150	0.050	5.00	2.50	4770	716	
		12.00	3	150	0.059	6.00	3.00	3970	703	
		16.00	3	150	0.072	8.00	4.00	2980	644	
		20.00	3	150	0.090	10.00	5.00	2380	643	

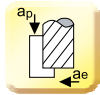

- Please start a test cutting with 85% of the V_c or 75% of the f_z, then increase the cutting speed and feed rate.
- Please use high precision and high rigidity clamping system. The oscillation of the tool can not be over 0.01 mm.
- When a_p=1*d₁, f_z = 75% as the data in the table.
- Recommended operation: climb milling.

- Bitte führen Sie einen Testschnitt mit 85% der V_c und 75% des f_z durch. Nach erfolgtem Test können Sie die Schnittgeschwindigkeit bzw. die Vorschubwerte entsprechend erhöhen.
- Bitte verwenden Sie nur Spannmittel mit einer hohen Genauigkeit und einer hohen Spannkraft. Überprüfen Sie den Rundlauf der Werkzeuge. Sie sollten darauf achten, dass der Rundlauffehler nicht größer als 0.01 mm ist.
- Bei Fräsoperationen, die mit einer a_p=1*d₁ durchgeführt werden, ist f_z um 25% zu reduzieren.
- Empfohlene Fräsmethode: Gleichlaufräsen.

Milling - Fräsen

Solid Carbide end mills - Vollhartmetallschaftfräser

Recommended cutting data - Empfohlene Schnittdaten

Type Typ	Grade Sorte	Material Werkstoffe	d1 (mm)	Z	Vc (m/min)	fz (mm/z)	ap (mm)	ae (mm)	n (min ⁻¹)	Vf (mm/min)	
5502R304GF	KMG303	Steel Stahl HRC<25	3.00	4	160	0.020	3.00	0.20	16970	1358	
5602R304GF	KMG303		4.00	4	160	0.025	4.00	0.20	12730	1273	
5508R454GM	KMG303		5.00	4	160	0.028	5.00	0.30	10180	1140	
			6.00	4	160	0.036	6.00	0.30	8480	1221	
			8.00	4	160	0.052	8.00	0.40	6360	1323	
			10.00	4	160	0.065	10.00	0.50	5090	1323	
			12.00	4	160	0.079	12.00	0.60	4240	1340	
			16.00	4	160	0.095	16.00	0.80	3180	1208	
			20.00	4	160	0.110	20.00	1.00	2540	1118	
			Steel, Steel alloy Stahl, legierter Stahl HRC=25-38	3.00	4	120	0.016	3.00	0.20	12730	815
		4.00		4	120	0.020	4.00	0.20	9540	763	
		5.00		4	120	0.026	5.00	0.30	7630	794	
		6.00		4	120	0.031	6.00	0.30	6360	789	
		8.00		4	120	0.042	8.00	0.40	4770	801	
		10.00		4	120	0.053	10.00	0.50	3810	808	
		12.00		4	120	0.063	12.00	0.60	3180	801	
		16.00		4	120	0.079	16.00	0.80	2380	752	
		High alloy steel Hochlegierter Stahl	3.00	4	70	0.016	3.00	0.20	7420	475	
			4.00	4	70	0.020	4.00	0.20	5570	446	
			5.00	4	70	0.026	5.00	0.30	4450	463	
			6.00	4	70	0.031	6.00	0.30	3710	460	
			8.00	4	70	0.042	8.00	0.40	2780	467	
			10.00	4	70	0.053	10.00	0.50	2220	471	
			12.00	4	70	0.063	12.00	0.60	1850	466	
			16.00	4	70	0.079	16.00	0.80	1390	439	
		Stainless steel Rostfreier Stahl	20.00	4	70	0.097	20.00	1.00	1110	431	
			Cast iron Guss	3.00	4	150	0.022	3.00	0.20	15910	1400
				4.00	4	150	0.025	4.00	0.20	11930	1193
				5.00	4	150	0.030	5.00	0.30	9540	1145
				6.00	4	150	0.039	6.00	0.30	7950	1240
				8.00	4	150	0.054	8.00	0.40	5960	1287
				10.00	4	150	0.066	10.00	0.50	4770	1259
				12.00	4	150	0.085	12.00	0.60	3970	1350
		16.00		4	150	0.100	16.00	0.80	2980	1192	
		Ti and Ti alloys Ti-Legierungen	20.00	4	150	0.120	20.00	1.00	2380	1142	
			3.00	4	80	0.015	3.00	0.20	8480	509	
			4.00	4	80	0.020	4.00	0.20	6360	509	
			5.00	4	80	0.025	5.00	0.30	5090	509	
			6.00	4	80	0.029	6.00	0.30	4240	492	
			8.00	4	80	0.042	8.00	0.40	3180	534	
			10.00	4	80	0.050	10.00	0.50	2540	508	
			12.00	4	80	0.059	12.00	0.60	2120	500	
		Ni-High temperature alloys Ni-Warmfeste Superlegierungen	16.00	4	80	0.072	16.00	0.80	1590	458	
			20.00	4	80	0.090	20.00	1.00	1270	457	
			3.00	4	40	0.016	3.00	0.20	4240	271	
			4.00	4	40	0.020	4.00	0.20	3180	254	
			5.00	4	40	0.026	5.00	0.30	2540	264	
			6.00	4	40	0.031	6.00	0.30	2120	263	
			8.00	4	40	0.042	8.00	0.40	1590	267	
			10.00	4	40	0.053	10.00	0.50	1270	269	
		12.00	4	40	0.063	12.00	0.60	1060	267		
		16.00	4	40	0.079	16.00	0.80	790	250		
		20.00	4	40	0.097	20.00	1.00	630	244		

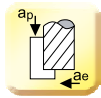

- Please start a test cutting with 85% of the Vc or 75% of the fz, then increase the cutting speed and feed rate.
- Please use high precision and high rigidity clamping system. The oscillation of the tool can not be over 0.01 mm.
- When $ap=1*d1$, $fz = 75%$ as the data in the table.
- Recommended operation: climb milling.

- Bitte führen Sie einen Testschnitt mit 85% der Vc und 75% des fz durch. Nach erfolgreichem Test können Sie die Schnittgeschwindigkeit bzw. die Vorschubwerte entsprechend erhöhen.
- Bitte verwenden Sie nur Spannmittel mit einer hohen Genauigkeit und einer hohen Spannkraft. Überprüfen Sie den Rundlauf der Werkzeuge. Sie sollten darauf achten, dass der Rundlauffehler nicht größer als 0.01 mm ist.
- Bei Fräsoperationen, die mit einer $ap=1*d1$ durchgeführt werden, ist fz um 25% zu reduzieren.
- Empfohlene Fräsmethode: Gleichlaufräsen.

B

Solid Carbide end mills
Vollhartmetallschaftfräser

Recommended cutting data · Empfohlene Schnittdaten

GM-4E-G | GM-4EL-G

Workpiece material Werkstück-material	Cast iron, Nodular cast iron Grauguss GGG		Carbon steel, Alloy steel Kohlenstoffstahl Leg. Stahl ~750N/mm ²		Carbon steel, Alloy steel Kohlenstoffstahl Leg. Stahl ~30HRC		Pre-hardened steel, Quenched and tempered steel Vergüteter Stahl ~40HRC		Stainless steel Rostfreier Stahl		Pre-hardened steel, Quenched and tempered steel Vergüteter Stahl ~50HRC	
	Diameter Ø Durchmesser (mm)	Rotating Drehzahl (min ⁻¹)	Feed Vorschub (mm/min)	Rotating Drehzahl (min ⁻¹)	Feed Vorschub (mm/min)	Rotating Drehzahl (min ⁻¹)	Feed Vorschub (mm/min)	Rotating Drehzahl (min ⁻¹)	Feed Vorschub (mm/min)	Rotating Drehzahl (min ⁻¹)	Feed Vorschub (mm/min)	Rotating Drehzahl (min ⁻¹)
1	20000	225	20000	225	20000	180	20000	180	20000	80	20000	135
2	15000	360	15000	360	15000	325	15000	315	11150	90	13000	200
3	14000	610	14000	610	13000	570	10600	470	7500	110	8500	370
4	10800	630	10800	630	10000	575	8000	480	5500	115	6500	380
5	8200	660	8200	660	7600	600	6400	505	4500	115	5000	400
6	7000	675	7000	675	6400	620	5300	515	3700	120	4200	405
8	5200	665	5200	665	4800	610	4000	510	2800	120	3200	415
10	4200	660	4200	660	3800	600	3200	505	2200	120	2500	390
12	3500	660	3500	660	3200	600	2650	505	1850	120	2100	390
14	3000	610	3000	610	2700	570	2300	470	1600	115	1800	370
16	2600	610	2600	610	2400	570	2000	470	1400	110	1600	370
18	2300	600	2300	600	2100	560	1800	460	1250	95	1400	365
20	2050	600	2050	600	1900	560	1600	460	1100	95	1250	365

Max. cutting depth max Schnitttiefe									
	<table border="1"> <thead> <tr> <th colspan="2">Milling slot · Nutenfräsen</th> </tr> <tr> <th>Ø</th> <th>Ap</th> </tr> </thead> <tbody> <tr> <td>Ø1 ≤ D < Ø3</td> <td>0.15D</td> </tr> <tr> <td>Ø3 ≤ D</td> <td>0.3D</td> </tr> </tbody> </table>	Milling slot · Nutenfräsen		Ø	Ap	Ø1 ≤ D < Ø3	0.15D	Ø3 ≤ D	0.3D
Milling slot · Nutenfräsen									
Ø	Ap								
Ø1 ≤ D < Ø3	0.15D								
Ø3 ≤ D	0.3D								

- The above table shows the standard value of side milling. When slot milling, of rotating speed 50%~70% and feed rate like mentioned above 40%~60%.
- Please select high precise machine and tool holder.
- Please use air blow or cutting liquid with high mist retardant property.
- Down milling is recommended in side milling.
- Vibration and unusual noise may be generated if the machine rigidity and workpiece fixture stability is low, please reduce the rotating speed and feed rate like mentioned above.
- Make overhang as short as possible if no interference.

- Die obige Tabelle zeigt Standard Werte für das Eckfräsen. Bei Nutenfräsen, Schnittgeschwindigkeit auf 50-70% und den Vorschub auf 40-60% reduzieren.
- Bitte präzise Maschinen und Werkzeughalter verwenden.
- Bitte Luftkühlung oder Schneidflüssigkeit benutzen.
- Empfohlene Fräsmethode: Gleichlaufräsen.
- Bei Vibrationen oder unüblichen Geräuschen reduzieren Sie die Schnittdaten (wie oben empfohlen) entsprechend.
- Werkzeugauskrägung so kurz wie möglich wählen.

Milling - Fräsen

Solid Carbide end mills - Vollhartmetallschaftfräser

Recommended cutting data · Empfohlene Schnittdaten

GM-4F-G | GM-4FL-G

Workpiece material Werkstückmaterial	Cast iron, Nodular cast iron Grauguss GGG		Carbon steel, Alloy steel Kohlenstoffstahl Leg. Stahl ~750N/mm ²		Carbon steel, Alloy steel Kohlenstoffstahl Leg. Stahl ~30HRC		Pre-hardened steel, Quenched and tempered steel Vergüteter Stahl ~40HRC		Stainless steel Rostfreier Stahl		Pre-hardened steel, Quenched and tempered steel Vergüteter Stahl ~50HRC	
	Diameter Ø Durchmesser (mm)	Rotating Drehzahl (min ⁻¹)	Feed Vorschub (mm/min)	Rotating Drehzahl (min ⁻¹)	Feed Vorschub (mm/min)	Rotating Drehzahl (min ⁻¹)	Feed Vorschub (mm/min)	Rotating Drehzahl (min ⁻¹)	Feed Vorschub (mm/min)	Rotating Drehzahl (min ⁻¹)	Feed Vorschub (mm/min)	Rotating Drehzahl (min ⁻¹)
1	20000	160	20000	160	20000	125	20000	125	20000	55	20000	95
2	15000	250	15000	250	15000	230	15000	220	11150	65	13000	140
3	14000	430	14000	430	13000	400	10600	330	7500	80	8500	260
4	10800	440	10800	440	10000	400	8000	335	5500	80	6500	265
5	8200	460	8200	460	7600	420	6400	355	4500	80	5000	280
6	7000	470	7000	470	6400	435	5300	360	3700	85	4200	285
8	5200	465	5200	465	4800	430	4000	360	2800	85	3200	290
10	4200	460	4200	460	3800	420	3200	355	2200	85	2500	275
12	3500	460	3500	460	3200	420	2650	355	1850	80	2100	275
14	3000	430	3000	430	2700	400	2300	330	1600	80	1800	260
16	2600	430	2600	430	2400	400	2000	330	1400	80	1600	260
18	2300	420	2300	420	2100	390	1800	325	1250	70	1400	255
20	2050	420	2050	420	1900	390	1600	325	1100	70	1250	255

Max. cutting depth max Schnitttiefe									
	<table border="1"> <thead> <tr> <th>Milling slot</th> <th>Nutenfräsen</th> </tr> <tr> <th>Ø</th> <th>Ap</th> </tr> </thead> <tbody> <tr> <td>Ø1 ≤ D < Ø3</td> <td>0.15D</td> </tr> <tr> <td>Ø3 ≤ D</td> <td>0.3D</td> </tr> </tbody> </table>	Milling slot	Nutenfräsen	Ø	Ap	Ø1 ≤ D < Ø3	0.15D	Ø3 ≤ D	0.3D
Milling slot	Nutenfräsen								
Ø	Ap								
Ø1 ≤ D < Ø3	0.15D								
Ø3 ≤ D	0.3D								

- The above table shows the standard value of side milling. When slot milling, of rotating speed 50%~70% and feed rate like mentioned above 40%~60%.
- Please select high precise machine and tool holder.
- Please use air blow or cutting liquid with high mist retardant property.
- Down milling is recommended in side milling.
- Vibration and unusual noise may be generated if the machine rigidity and workpiece fixture stability is low, please reduce the rotating speed and feed rate like mentioned above.
- Make overhang as short as possible if no interference.

- Die obige Tabelle zeigt Standard Werte für das Eckfräsen. Bei Nutenfräsen, Schnittgeschwindigkeit auf 50-70% und den Vorschub auf 40-60% reduzieren.
- Bitte präzise Maschinen und Werkzeughalter verwenden.
- Bitte Luftkühlung oder Schneidflüssigkeit benutzen.
- Empfohlene Fräsmethode: Gleichlaufräsen.
- Bei Vibrationen oder unüblichen Geräuschen reduzieren Sie die Schnittdaten (wie oben empfohlen) entsprechend.
- Werkzeugauskragung so kurz wie möglich wählen.

Recommended cutting data · Empfohlene Schnittdaten

GM-4EX-G

Workpiece material Werkstückmaterial	Cast iron, Nodular cast iron Grauguss GGG		Carbon steel, Alloy steel Kohlenstoffstahl Leg. Stahl ~750N/mm ²		Carbon steel, Alloy steel Kohlenstoffstahl Leg. Stahl ~30HRC		Pre-hardened steel, Quenched and tempered steel Vergüteter Stahl ~40HRC		Stainless steel Rostfreier Stahl		Pre-hardened steel, Quenched and tempered steel Vergüteter Stahl ~50HRC	
	Diameter Ø Durchmesser (mm)	Rotating Drehzahl (min ⁻¹)	Feed Vorschub (mm/min)	Rotating Drehzahl (min ⁻¹)	Feed Vorschub (mm/min)	Rotating Drehzahl (min ⁻¹)	Feed Vorschub (mm/min)	Rotating Drehzahl (min ⁻¹)	Feed Vorschub (mm/min)	Rotating Drehzahl (min ⁻¹)	Feed Vorschub (mm/min)	Rotating Drehzahl (min ⁻¹)
6	5800	475	5800	475	5300	430	4250	340	2650	70	3600	290
8	4400	475	4400	475	4000	430	3180	340	2000	70	2700	290
10	3500	460	3500	460	3200	420	2550	330	1600	70	2150	280
12	2900	460	2900	460	2650	420	2120	330	1350	70	1800	280
16	2200	430	2200	430	2000	390	1590	315	1000	65	1350	260
20	1750	430	1750	430	1600	385	1270	310	800	60	1050	255
Max. cutting depth max. Schnitttiefe	<p>The diagram illustrates the maximum cutting depth parameters for a milling operation. It shows a cross-section of a workpiece being milled. The maximum axial cutting depth is labeled as $a_e = 0.02D$, where D is the diameter of the end mill. The maximum radial cutting depth is labeled as $a_p = 3D$.</p>											

1. Please select high precise machine and tool holder.
2. Please use air blow or cutting liquid with high mist retardant property.
3. Down milling is recommended in side milling.
4. Vibration and unusual noise may be generated if the machine rigidity and workpiece fixture stability is low, please reduce the rotating speed and feed rate like mentioned above.
5. Make overhang as short as possible if no interference.

1. Bitte präzise Maschinen und Werkzeughalter verwenden.
2. Bitte Luftkühlung oder Schneidflüssigkeit benutzen.
3. Empfohlene Fräsmethode: Gleichlaufräsen.
4. Bei Vibrationen oder unüblichen Geräuschen reduzieren Sie die Schnittdaten (wie oben empfohlen) entsprechend.
5. Werkzeugauskrantung so kurz wie möglich wählen.

Milling · Fräsen

Solid Carbide end mills · Vollhartmetallschaftfräser

Recommended cutting data · Empfohlene Schnittdaten

GM-4E | GM-4EL

Workpiece material Werkstückmaterial	Cast iron, Nodular cast iron Grauguss GGG		Carbon steel, Alloy steel Kohlenstoffstahl Leg. Stahl ~750N/mm ²		Carbon steel, Alloy steel Kohlenstoffstahl Leg. Stahl ~30HRC		Pre-hardened steel, Quenched and tempered steel Vergüteter Stahl ~40HRC		Stainless steel Rostfreier Stahl		Pre-hardened steel, Quenched and tempered steel Vergüteter Stahl ~50HRC	
	Diameter Ø Durchmesser (mm)	Rotating Drehzahl (min ⁻¹)	Feed Vorschub (mm/min)	Rotating Drehzahl (min ⁻¹)	Feed Vorschub (mm/min)	Rotating Drehzahl (min ⁻¹)	Feed Vorschub (mm/min)	Rotating Drehzahl (min ⁻¹)	Feed Vorschub (mm/min)	Rotating Drehzahl (min ⁻¹)	Feed Vorschub (mm/min)	Rotating Drehzahl (min ⁻¹)
1	20000	250	20000	250	20000	200	20000	200	20000	90	20000	150
2	15000	400	15000	400	15000	360	15000	350	11150	100	13000	225
3	14000	680	14000	680	13000	630	10600	525	7500	120	8500	410
4	10800	700	10800	700	10000	640	8000	535	5500	125	6500	420
5	8200	730	8200	730	7600	670	6400	560	4500	125	5000	440
6	7000	750	7000	750	6400	690	5300	575	3700	135	4200	450
8	5200	740	5200	740	4800	680	4000	565	2800	135	3200	460
10	4200	730	4200	730	3800	670	3200	560	2200	135	2500	435
12	3500	730	3500	730	3200	670	2650	560	1850	135	2100	435
14	3000	680	3000	680	2700	630	2300	525	1600	125	1800	410
16	2600	680	2600	680	2400	630	2000	525	1400	120	1600	410
18	2300	670	2300	670	2100	620	1800	515	1250	105	1400	405
20	2050	670	2050	670	1900	620	1600	515	1100	105	1250	405

Max. cutting depth max Schnitttiefe									
	<table border="1"> <thead> <tr> <th colspan="2">Milling slot · Nutenfräsen</th> </tr> <tr> <th>Ø</th> <th>Ap</th> </tr> </thead> <tbody> <tr> <td>Ø1 ≤ D < Ø3</td> <td>0.15D</td> </tr> <tr> <td>Ø3 ≤ D</td> <td>0.3D</td> </tr> </tbody> </table>	Milling slot · Nutenfräsen		Ø	Ap	Ø1 ≤ D < Ø3	0.15D	Ø3 ≤ D	0.3D
Milling slot · Nutenfräsen									
Ø	Ap								
Ø1 ≤ D < Ø3	0.15D								
Ø3 ≤ D	0.3D								

- The above table shows the standard value of side milling. When slot milling, of rotating speed 50%~70% and feed rate like mentioned above 40%~60%.
- Please select high precise machine and tool holder.
- Please use air blow or cutting liquid with high mist retardant property.
- Down milling is recommended in side milling.
- Vibration and unusual noise may be generated if the machine rigidity and workpiece fixture stability is low, please reduce the rotating speed and feed rate like mentioned above.
- Make overhang as short as possible if no interference.

- Die obige Tabelle zeigt Standard Werte für das Eckfräsen. Bei Nutenfräsen, Schnittgeschwindigkeit auf 50-70% und den Vorschub auf 40-60% reduzieren.
- Bitte präzise Maschinen und Werkzeughalter verwenden.
- Bitte Luftkühlung oder Schneidflüssigkeit benutzen.
- Empfohlene Fräsmethode: Gleichlaufräsen.
- Bei Vibrationen oder unüblichen Geräuschen reduzieren Sie die Schnittdaten (wie oben empfohlen) entsprechend.
- Werkzeugauskragung so kurz wie möglich wählen.

Recommended cutting data · Empfohlene Schnittdaten

GM-4EFP

Workpiece material Werkstückmaterial	Cast iron, Nodular cast iron Grauguss GGG		Carbon steel, Alloy steel Kohlenstoffstahl Leg. Stahl ~750N/mm ²		Carbon steel, Alloy steel Kohlenstoffstahl Leg. Stahl ~30HRC		Pre-hardened steel, Quenched and tempered steel Vergüteter Stahl ~40HRC		Stainless steel Rostfreier Stahl		Pre-hardened steel, Quenched and tempered steel Vergüteter Stahl ~50HRC	
	Diameter Ø Durchmesser (mm)	Rotating Drehzahl (min ⁻¹)	Feed Vorschub (mm/min)	Rotating Drehzahl (min ⁻¹)	Feed Vorschub (mm/min)	Rotating Drehzahl (min ⁻¹)	Feed Vorschub (mm/min)	Rotating Drehzahl (min ⁻¹)	Feed Vorschub (mm/min)	Rotating Drehzahl (min ⁻¹)	Feed Vorschub (mm/min)	Rotating Drehzahl (min ⁻¹)
6	7000	975	7000	975	6400	900	5300	750	3700	175	4200	585
8	5200	960	5200	960	4800	995	4000	735	2800	175	3200	600
10	4200	950	4200	950	3800	970	3200	730	2200	175	2500	565
12	3500	950	3500	950	3200	970	2650	730	1850	175	2100	565
16	2600	885	2600	885	2400	820	2000	680	1400	155	1600	535
20	2050	870	2050	870	1900	805	1600	670	1100	135	1250	525

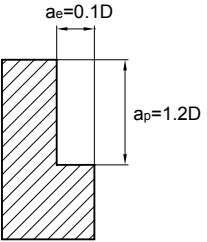
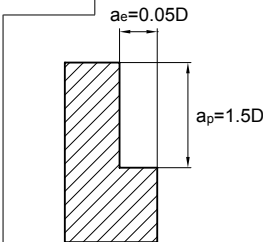
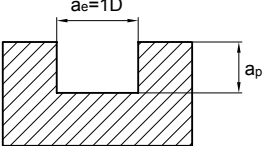
Max. cutting depth max. Schnitttiefe									
	 <table border="1" data-bbox="790 1142 1085 1265"> <thead> <tr> <th colspan="2">Milling slot · Nutenfräsen</th> </tr> <tr> <th>Ø</th> <th>Ap</th> </tr> </thead> <tbody> <tr> <td>Ø1 ≤ D < Ø3</td> <td>0.15D</td> </tr> <tr> <td>Ø3 ≤ D</td> <td>0.3D</td> </tr> </tbody> </table>	Milling slot · Nutenfräsen		Ø	Ap	Ø1 ≤ D < Ø3	0.15D	Ø3 ≤ D	0.3D
Milling slot · Nutenfräsen									
Ø	Ap								
Ø1 ≤ D < Ø3	0.15D								
Ø3 ≤ D	0.3D								

- The above table shows the standard value of side milling. When slot milling, of rotating speed 50%~70% and feed rate like mentioned above 40%~60%.
- Please select high precise machine and tool holder.
- Please use air blow or cutting liquid with high mist retardant property.
- Down milling is recommended in side milling.
- Vibration and unusual noise may be generated if the machine rigidity and workpiece fixture stability is low, please reduce the rotating speed and feed rate like mentioned above.
- Make overhang as short as possible if no interference.

- Die obige Tabelle zeigt Standard Werte für das Eckfräsen. Bei Nutenfräsen, Schnittgeschwindigkeit auf 50-70% und den Vorschub auf 40-60% reduzieren.
- Bitte präzise Maschinen und Werkzeughalter verwenden.
- Bitte Luftkühlung oder Schneidflüssigkeit benutzen.
- Empfohlene Fräsmethode: Gleichlaufräsen.
- Bei Vibrationen oder unüblichen Geräuschen reduzieren Sie die Schnittdaten (wie oben empfohlen) entsprechend.
- Werkzeugauskrägung so kurz wie möglich wählen.

Milling · Fräsen

Solid Carbide end mills · Vollhartmetallschaftfräser

ZCC CT 6-flute slotting end mills (HRC<=50) · **ZCC CT** 6-Schneiden VHM Langlochfräser (HRC<=50)

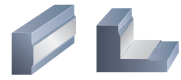

5589R45MGFR

KMG405: nano TiAlN coated ultra-fine carbide / nano TiAlN beschichtetes Ultrafeinkornhartmetall

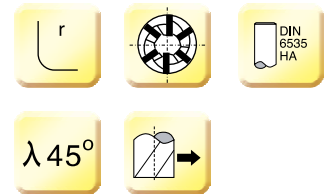
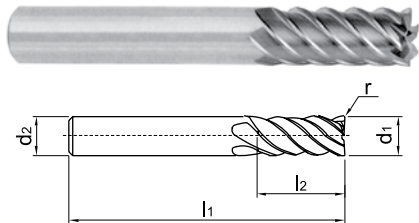

Type Typ	Dimension(mm) Abmessungen					Teeth Zähne	Application Anwendung	P K	
	d1(e8)	d2(h6)	l2	l1	r			Grade Sorte	KMG405
5589R45MGFR02-0600	6.00	6	19	63	0.2	6		●	
5589R45MGFR02-0800	8.00	8	28	72	0.2	6		●	
5589R45MGFR02-1000	10.00	10	34	84	0.2	6		●	
5589R45MGFR02-1200	12.00	12	40	97	0.2	6		●	
5589R45MGFR03-1600	16.00	16	48	108	0.3	8		●	
5589R45MGFR03-2000	20.00	20	56	122	0.3	10		●	
Art. Group No. / Produktgruppe Nr. :								021130	

B

Solid Carbide end mills
Vollhartmetallschaftfräser

Material Overview · Material Übersicht

✓ = Very suitable · Sehr empfohlen
✓ = Suitable · Empfohlen

KMG405

Workpiece material Werkstückstoff											
Carbon steel Kohlenstoff Stahl	Alloy steel Legierter Stahl	Quenched and tempered steel · Vergüteter Stahl		Hardened steel · Gehärteter Stahl		Stainless steel · Rostfreier Stahl	Cast iron, Nodular cast iron Grauguss GGG	Copper alloy Kupfer Leg	Aluminum alloy Alu Leg	Titanium alloy Titan Leg	Heat resist alloy warmfeste Leg
		~40HRC	~50HRC	~55HRC	~68HRC						
✓	✓	✓	✓			✓	✓				

● Ex Stock / ab Lager ○ On demand / auf Anfrage

GM-6E

6-flute end mills with straight shank
6-Schneiden Eckfräser mit Zylinderschaft

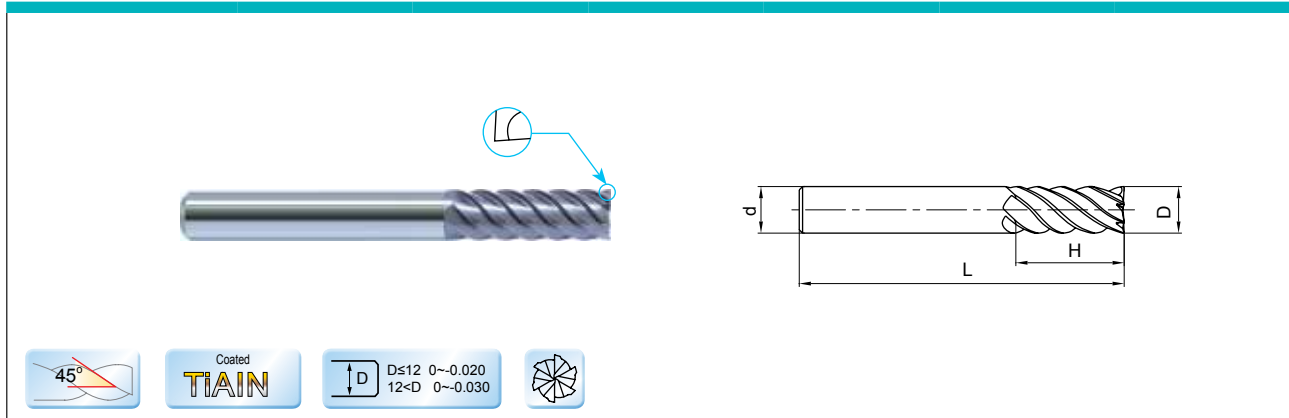

Type Typ	Dimension(mm) Abmessungen				Teeth Zähne Z	Grade Sorte KMG 303
	D	d	H	L		
GM-6E-D6.0	6.0	6	18	60	6	●
GM-6E-D8.0	8.0	8	20	60	6	●
GM-6E-D10.0	10.0	10	30	75	6	●
GM-6E-D12.0	12.0	12	32	75	6	●
GM-6E-D16.0	16.0	16	40	100	6	●
GM-6E-D20.0	20.0	20	45	100	6	●

B

Solid Carbide end mills
Vollhartmetallschaftfräser

Material Overview · Material Übersicht

✓ = Very suitable · Sehr empfohlen
✓ = Suitable · Empfohlen

KMG303

Workpiece material Werkstückstoff											
Carbon steel Kohlenstoff Stahl	Alloy steel Legierter Stahl	Quenched and tempered steel · Vergüteter Stahl		Hardened steel · Gehärteter Stahl		Stainless steel · Rostfreier Stahl	Cast iron, Nodular cast iron Grauguss GGG	Copper alloy Kupfer Leg	Aluminum alloy Alu Leg	Titanium alloy Titan Leg	Heat resist alloy warmfeste Leg
		~40HRC	~50HRC	~55HRC	~68HRC						
✓	✓	✓	✓			✓	✓				

Code key **B252,B254**
ISO Kennzeichen

Cutting data **B365-B367**
Schnittdaten

Graphics identification & application **B253-B255**
Graphische Werkzeug- & Anwendungsbeschr.

Order form for non-standard products **B534-B535**
Bestellformular für Sonderwerkzeuge

B363

Milling · Fräsen

Solid Carbide end mills · Vollhartmetallschaftfräser

GM-6EL series for general machining · **GM-6EL** Serie für allgemeine Bearbeitung

6-flute end mills with straight shank and long cutting edge
6-Schneiden Eckfräser mit langer Schneide und Zylinderschaft

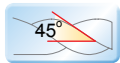
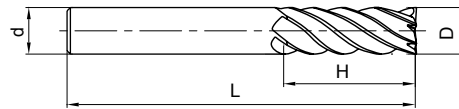
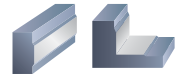

Type Typ	Dimension (mm) Abmessungen				Teeth Zähne Z	Grade Sorte KMG 303
	D	d	H	L		
GM-6EL-D6.0	6.0	6	24	75	6	●
GM-6EL-D8.0	8.0	8	32	75	6	●
GM-6EL-D10.0	10.0	10	40	100	6	●
GM-6EL-D12.0	12.0	12	45	100	6	●
GM-6EL-D16.0	16.0	16	64	150	6	●
GM-6EL-D20.0	20.0	20	75	150	6	●

Solid Carbide end mills
Vollhartmetallschaftfräser

B

Material Overview · Material Übersicht



✓ = Very suitable · Sehr empfohlen
✓ = Suitable · Empfohlen

KMG405

Workpiece material Werkstückstoff											
Carbon steel Kohlenstoff Stahl	Alloy steel Legierter Stahl	Quenched and tempered steel · Vergüteter Stahl		Hardened steel · Gehärteter Stahl		Stainless steel · Rostfreier Stahl	Cast iron, Nodular cast iron Grauguss GGG	Copper alloy Kupfer Leg	Aluminum alloy Alu Leg	Titanium alloy Titan Leg	Heat resist alloy warmfeste Leg
		~40HRC	~50HRC	~55HRC	~68HRC						
✓	✓	✓	✓			✓	✓				

● Ex Stock / ab Lager ○ On demand / auf Anfrage

Recommended cutting data · Empfohlene Schnittdaten

Type Typ	Grade Sorte	Material Werkstoffe	d ₁ (mm)	z	V _c (m/min)	f _z (mm/z)	a _p (mm)	a _e (mm)	n (min ⁻¹)	V _f (mm/min)
 	KMG405	P Steel Stahl HRC<30	6.00	6	130	0.011	15.00	0.30	6890	455
			8.00	6	130	0.016	20.00	0.40	5170	496
			10.00	6	130	0.021	25.00	0.50	4130	520
			12.00	6	130	0.026	30.00	0.60	3440	537
			16.00	8	130	0.032	40.00	0.80	2580	660
			20.00	10	130	0.038	50.00	1.00	2060	783
			6.00	6	90	0.011	15.00	0.30	4770	315
			8.00	6	90	0.016	20.00	0.40	3580	344
			10.00	6	90	0.021	25.00	0.50	2860	360
			12.00	6	90	0.026	30.00	0.60	2380	371
		16.00	8	90	0.032	40.00	0.80	1790	458	
		20.00	10	90	0.038	50.00	1.00	1430	543	
		P High alloy steel Hoch legierter Stahl	6.00	6	50	0.011	15.00	0.30	2650	175
			8.00	6	50	0.016	20.00	0.40	1980	190
			10.00	6	50	0.021	25.00	0.50	1590	200
			12.00	6	50	0.026	30.00	0.60	1320	206
			16.00	8	50	0.032	40.00	0.80	990	253
			20.00	10	50	0.038	50.00	1.00	790	300
		K Cast iron Guss	6.00	6	100	0.011	15.00	0.30	5300	350
			8.00	6	100	0.016	20.00	0.40	3970	381
			10.00	6	100	0.021	25.00	0.50	3180	401
			12.00	6	100	0.026	30.00	0.60	2650	413
			16.00	8	100	0.032	40.00	0.80	1980	507
		20.00	10	100	0.038	50.00	1.00	1590	604	
		H Hard steel Gehärteter Stahl HRC = 48-54	6.00	6	60	0.011	15.00	0.30	3180	210
			8.00	6	60	0.016	20.00	0.40	2380	228
			10.00	6	60	0.021	25.00	0.50	1900	239
			12.00	6	60	0.026	30.00	0.60	1590	248
16.00	8		60	0.032	40.00	0.80	1190	305		
20.00	10		60	0.038	50.00	1.00	950	361		

- Please start a test cutting with 85% of the V_c or 75% of the f_z, then increase the cutting speed and feed rate.
- Please use high precision and high rigidity clamping system. The oscillation of the tool can not be over 0.01 mm.
- When a_p=1*d₁, f_z = 75% as the data in the table.
- Recommended operation: climb milling.

- Bitte führen Sie einen Testschnitt mit 85% der V_c und 75% des f_z durch.
Nach erfolgreichem Test können Sie die Schnittgeschwindigkeit bzw. die Vorschubwerte entsprechend erhöhen.
- Bitte verwenden Sie nur Spannmittel mit einer hohen Genauigkeit und einer hohen Spannkraft.
Überprüfen Sie den Rundlauf der Werkzeuge. Sie sollten darauf achten, dass der Rundlauffehler nicht größer als 0.01 mm ist.
- Bei Fräsoperationen, die mit einer a_p=1*d₁ durchgeführt werden, ist f_z um 25% zu reduzieren.
- Empfohlene Fräsmethode: Gleichlaufräsen.



Code key **B252, B254**
ISO Kennzeichen



Cutting data **B365-B367**
Schnittdaten



Graphics identification & application **B253-B255**
Graphische Werkzeug- & Anwendungsbeschr.



Order form for non-standard products **B534-B535**
Bestellformular für Sonderwerkzeuge

Milling - Fräsen

Solid Carbide end mills - Vollhartmetallschaftfräser

Recommended cutting data · Empfohlene Schnittdaten

GM-6E

Workpiece material Werkstückmaterial	Cast iron, Nodular cast iron Grauguss GGG		Carbon steel, Alloy steel Kohlenstoffstahl Leg. Stahl ~750N/mm ²		Carbon steel, Alloy steel Kohlenstoffstahl Leg. Stahl ~30HRC		Pre-hardened steel, Quenched and tempered steel Vergüteter Stahl ~40HRC		Stainless steel Rostfreier Stahl		Pre-hardened steel, Quenched and tempered steel Vergüteter Stahl ~50HRC	
	Diameter Ø Durchmesser (mm)	Rotating Drehzahl (min ⁻¹)	Feed Vorschub (mm/min)	Rotating Drehzahl (min ⁻¹)	Feed Vorschub (mm/min)	Rotating Drehzahl (min ⁻¹)	Feed Vorschub (mm/min)	Rotating Drehzahl (min ⁻¹)	Feed Vorschub (mm/min)	Rotating Drehzahl (min ⁻¹)	Feed Vorschub (mm/min)	Rotating Drehzahl (min ⁻¹)
6	7000	890	7000	890	6400	820	5300	680	3700	160	4200	540
8	5200	890	5200	890	4800	820	4000	680	2800	160	3200	550
10	4200	860	4200	860	3800	800	3200	665	2200	160	2500	520
12	3500	860	3500	860	3200	800	2650	665	1850	160	2100	520
14	3000	810	3000	810	2700	750	2300	625	1600	150	1800	490
16	2600	810	2600	810	2400	750	2000	625	1400	150	1600	490
18	2300	800	2300	800	2100	740	1800	615	1250	125	1400	485
20	2050	800	2050	800	1900	740	1600	615	1100	125	1250	485

Max. cutting depth
max Schnitttiefe

The diagram illustrates the maximum cutting depth parameters for the end mill. It shows a cross-section of the tool cutting into a workpiece. The axial cutting depth is labeled as $A_e = 0.05D$, and the radial cutting depth is labeled as $A_p = 1.5D$.

1. Please select high precise machine and tool holder.
2. Please use air blow or MQL (minimum oil mist cooling).
3. Down milling is recommended in side milling.
4. Vibration and unusual noise may be generated if the machine rigidity and workpiece fixture stability is low, please reduce the rotating speed and feed rate like mentioned above.
5. Make overhang as short as possible if no interference.

1. Bitte präzise Maschinen und Werkzeughalter verwenden.
2. Als Kühlmittel bitte Luft oder MQL (Minimalmengen) verwenden.
3. Empfohlene Fräsmethode: Gleichlaufräsen.
4. Bei Vibrationen oder unüblichen Geräuschen reduzieren Sie die Schnittdaten (wie oben empfohlen) entsprechend.
5. Werkzeugauskragung so kurz wie möglich wählen.

B

Solid Carbide end mills
Vollhartmetallschaftfräser

Recommended cutting data · Empfohlene Schnittdaten

GM-6EL

Workpiece material Werkstückmaterial	Cast iron, Nodular cast iron Grauguss GGG		Carbon steel, Alloy steel Kohlenstoffstahl Leg. Stahl ~750N/mm ²		Carbon steel, Alloy steel Kohlenstoffstahl Leg. Stahl ~30HRC		Pre-hardened steel, Quenched and tempered steel Vergüteter Stahl ~40HRC		Stainless steel Rostfreier Stahl		Pre-hardened steel, Quenched and tempered steel Vergüteter Stahl ~50HRC	
	Diameter Ø Durchmesser (mm)	Rotating Drehzahl (min ⁻¹)	Feed Vorschub (mm/min)	Rotating Drehzahl (min ⁻¹)	Feed Vorschub (mm/min)	Rotating Drehzahl (min ⁻¹)	Feed Vorschub (mm/min)	Rotating Drehzahl (min ⁻¹)	Feed Vorschub (mm/min)	Rotating Drehzahl (min ⁻¹)	Feed Vorschub (mm/min)	Rotating Drehzahl (min ⁻¹)
6	5800	750	5800	750	5300	685	4250	545	2650	115	3600	460
8	4400	750	4400	750	4000	685	3180	545	2000	115	2700	465
10	3500	730	3500	730	3200	665	2550	530	1600	115	2150	440
12	2900	730	2900	730	2650	665	2120	530	1350	115	1800	440
14	2500	685	2500	685	2300	625	1820	500	1150	105	1550	415
16	2200	685	2200	685	2000	625	1590	500	1000	105	1350	415
18	1950	675	1950	675	1800	615	1420	490	900	90	1200	410
20	1750	675	1750	675	1600	615	1270	490	800	90	1050	410
max. cutting depth max. Schnitttiefe												

1. Please select high precise machine and tool holder.
2. Please use air blow or MQL (minimum oil mist cooling).
3. Down milling is recommended in side milling.
4. Vibration and unusual noise may be generated if the machine rigidity and workpiece fixture stability is low, please reduce the rotating speed and feed rate like mentioned above.
5. Make overhang as short as possible if no interference.

1. Bitte präzise Maschinen und Werkzeughalter verwenden.
2. Als Kühlmittel bitte Luft oder MQL (Minimalmengen) verwenden.
3. Empfohlene Fräsmethode: Gleichlaufräsen.
4. Bei Vibrationen oder unüblichen Geräuschen reduzieren Sie die Schnittdaten (wie oben empfohlen) entsprechend.
5. Werkzeugauskrantung so kurz wie möglich wählen.

Milling · Fräsen

Solid Carbide end mills · Vollhartmetallschaftfräser

ZCC CT 2-flute ball nose end mills · ZCC CT 2-Schneiden VHM Kugelkopffräser



5565R302GF

KMG303: nano AlTiN coated Ultra-fine carbide / nano AlTiN beschichtetes Ultrafeinkornhartmetall

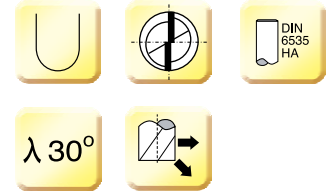
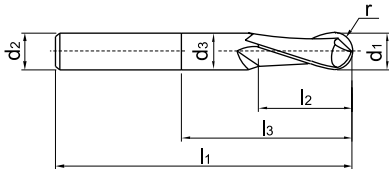

Type Typ	Dimension(mm) Abmessungen								Teeth Zähne	Application Anwendung	P M K		
	d1	d2(h6)	l2	l1	d3	l3	r(fs)	α°			z	Grade Sorte	KMG303
5565R302GF-0300	3.00	6	4	57	2.80	9	1.50	6	2			●	
5565R302GF-0400	4.00	6	5	57	3.70	12	2.00	4	2			●	
5565R302GF-0500	5.00	6	6	57	4.60	15	2.50	2	2			●	
5565R302GF-0600	6.00	6	7	57	5.50	20	3.00	-	2			●	
5565R302GF-0800	8.00	8	9	63	7.40	26	4.00	-	2			●	
5565R302GF-1000	10.00	10	11	72	9.20	31	5.00	-	2			●	
5565R302GF-1200	12.00	12	12	83	11.00	37	6.00	-	2			●	
5565R302GF-1600	16.00	16	16	92	15.00	43	8.00	-	2			●	
5565R302GF-2000	20.00	20	20	104	19.00	50	10.00	-	2			●	

Art. Group No. / Produktgruppe Nr. : 021130

B

Solid Carbide end mills
Vollhartmetallschaftfräser

Material Overview · Material Übersicht

✓ = Very suitable · Sehr empfohlen
✓ = Suitable · Empfohlen

KMG303	Workpiece material Werkstückstoff											
	Carbon steel Kohlenstoff Stahl	Alloy steel Legierter Stahl	Quenched and tempered steel · Vergüteter Stahl		Hardened steel · Gehärteter Stahl		Stainless steel · Rostfreier Stahl	Cast iron, Nodular cast iron Grauguss GGG	Copper alloy Kupfer Leg	Aluminum alloy Alu Leg	Titanium alloy Titan Leg	Heat resist alloy warmfeste Leg
	✓	✓	✓	✓			✓	✓				

● Ex Stock / ab Lager ○ On demand / auf Anfrage

ZCC CT 2-flute ball nose end mills · ZCC CT 2-Schneiden VHM Kugelkopffräser

5665R202GM

KMG303: nano AlTiN coated Ultra-fine carbide / nano AlTiN beschichtetes Ultrafeinkornhartmetall

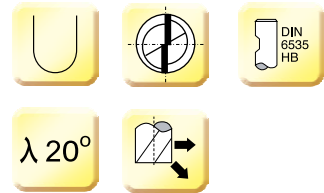
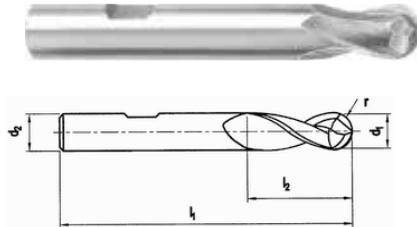

Type Typ	Dimension(mm) Abmessungen								Teeth Zähne	Application Anwendung	P M K		
	d1	d2(h6)	l2	l1	d3	l3	r(fs)	α°			z	Grade Sorte	KMG303
5665R202GM-0300	3.00	6	4	57	2.80	9	1.50	7	2			●	
5665R202GM-0400	4.00	6	5	57	3.70	12	2.00	5	2			●	
5665R202GM-0500	5.00	6	6	57	4.60	15	2.50	3	2			●	
5665R202GM-0600	6.00	6	7	57	5.50	20	3.00	-	2			●	
5665R202GM-0800	8.00	8	9	63	7.40	26	4.00	-	2			●	
5665R202GM-1000	10.00	10	11	72	9.20	31	5.00	-	2			●	
5665R202GM-1200	12.00	12	12	83	11.00	37	6.00	-	2			●	
5665R202GM-1600	16.00	16	16	92	15.00	43	8.00	-	2			●	
5665R202GM-2000	20.00	20	20	104	19.00	50	10.00	-	2			●	
Art. Group No. / Produktgruppe Nr. :											021130		

B

Solid Carbide end mills
Vollhartmetallschaftfräser

Material Overview · Material Übersicht

✓ = Very suitable · Sehr empfohlen
✓ = Suitable · Empfohlen

KMG303

Workpiece material Werkstückstoff											
Carbon steel Kohlenstoff Stahl	Alloy steel Legierter Stahl	Quenched and tempered steel · Vergüteter Stahl		Hardened steel · Gehärteter Stahl		Stainless steel · Rostfreier Stahl	Cast iron, Nodular cast iron Grauguss GGG	Copper alloy Kupfer Leg	Aluminum alloy Alu Leg	Titanium alloy Titan Leg	Heat resist alloy warmfeste Leg
		~40HRC	~50HRC	~55HRC	~68HRC						
✓	✓	✓	✓			✓	✓				

Code key **B252-B254**
ISO Kennzeichen

Cutting data **B374-B376**
Schnittdaten

Graphics identification & application **B253-B255**
Graphische Werkzeug- & Anwendungsbeschr.

Order form for non-standard products **B534-B535**
Bestellformular für Sonderwerkzeuge

B 369

Milling · Fräsen

Solid Carbide end mills · Vollhartmetallschaftfräser

ZCC CT 2-flute ball nose end mills (long) · ZCC CT 2-Schneiden VHM Kugelkopffräser (Lang)

5566R302GF

KMG303: nano AlTiN coated Ultra-fine carbide / nano AlTiN beschichtetes Ultrafeinkornhartmetall

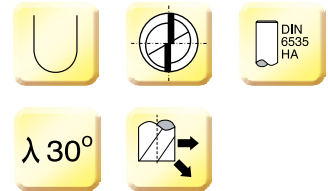
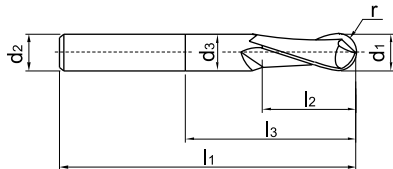

Type Typ	Dimension(mm) Abmessungen								Teeth Zähne	Application Anwendung	P M K		
	d1	d2(h6)	l2	l1	d3	l3	r(fs)	α°			z	Grade Sorte	KMG303
5566R302GF-0300	3.00	6	4	75	2.80	15	1.50	-	2			●	
5566R302GF-0400	4.00	6	5	75	3.70	20	2.00	-	2			●	
5566R302GF-0500	5.00	6	6	80	4.60	25	2.50	-	2			●	
5566R302GF-0600	6.00	6	7	80	5.50	60	3.00	-	2			●	
5566R302GF-0800	8.00	8	9	90	7.40	65	4.00	-	2			●	
5566R302GF-1000	10.00	10	11	100	9.20	40	5.00	-	2			●	
5566R302GF-1200	12.00	12	12	120	11.00	50	6.00	-	2			●	

Art. Group No. / Produktgruppe Nr. : 021130

B

Solid Carbide end mills
Vollhartmetallschaftfräser

Material Overview · Material Übersicht

✓ = Very suitable · Sehr empfohlen
✓ = Suitable · Empfohlen

KMG303

Workpiece material Werkstückstoff											
Carbon steel Kohlenstoff Stahl	Alloy steel Legierter Stahl	Quenched and tempered steel · Vergüteter Stahl		Hardened steel · Gehärteter Stahl		Stainless steel · Rostfreier Stahl	Cast iron, Nodular cast iron Grauguss GGG	Copper alloy Kupfer Leg	Aluminum alloy Alu Leg	Titanium alloy Titan Leg	Heat resist alloy warmfeste Leg
		~40HRC	~50HRC	~55HRC	~68HRC						
✓	✓	✓	✓			✓	✓				

● Ex Stock / ab Lager ○ On demand / auf Anfrage

GM-2B

2-flute ball nose end mills with straight shank
2-Schneiden Kugelkopffräser mit Zylinderschaft

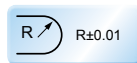
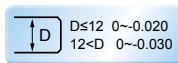
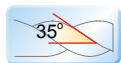
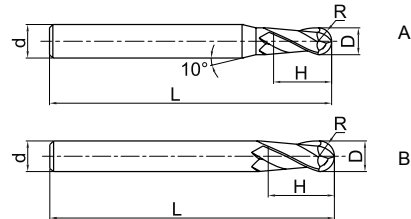

Type Typ	Dimension(mm) Abmessungen					Teeth Zähne Z	Geometry Ausführung	Grade Sorte KMG 303
	D	R	d	H	L			
GM-2B-R0.5S	1.0	0.5	4	2	50	2	A	●
GM-2B-R0.75S	1.5	0.75	4	3	50	2	A	●
GM-2B-R1.0S	2.0	1.0	4	4	50	2	A	●
GM-2B-R1.25S	2.5	1.25	4	5	50	2	A	●
GM-2B-R1.5S	3.0	1.5	4	6	50	2	A	●
GM-2B-R2.0S	4.0	2.0	4	8	50	2	B	●
GM-2B-R0.5	1.0	0.5	6	2	50	2	A	●
GM-2B-R0.75	1.5	0.75	6	3	50	2	A	●
GM-2B-R1.0	2.0	1.0	6	4	50	2	A	●
GM-2B-R1.25	2.5	1.25	6	5	50	2	A	○
GM-2B-R1.5	3.0	1.5	6	6	50	2	A	●
GM-2B-R1.75	3.5	1.75	6	8	50	2	A	○
GM-2B-R2.0	4.0	2.0	6	8	50	2	A	●
GM-2B-R2.5	5.0	2.5	6	10	50	2	A	●
GM-2B-R2.75	5.5	2.75	6	12	50	2	A	○
GM-2B-R3.0	6.0	3.0	6	12	50	2	B	●
GM-2B-R3.5	7.0	3.5	8	14	60	2	A	●
GM-2B-R4.0	8.0	4.0	8	16	60	2	B	●
GM-2B-R4.5	9.0	4.5	10	18	75	2	A	●
GM-2B-R5.0	10	5.0	10	20	75	2	B	●
GM-2B-R6.0	12	6.0	12	24	75	2	B	●
GM-2B-R7.0	14	7.0	14	28	75	2	B	○
GM-2B-R8.0	16	8.0	16	32	100	2	B	●
GM-2B-R10.0	20	10.0	20	40	100	2	B	●

Material Overview · Material Übersicht

✓ = Very suitable · Sehr empfohlen
✓ = Suitable · Empfohlen

KMG303

Workpiece material Werkstückstoff											
Carbon steel Kohlenstoff Stahl	Alloy steel Legierter Stahl	Quenched and tempered steel · Vergüteter Stahl		Hardened steel · Gehärteter Stahl		Stainless steel · Rostfreier Stahl	Cast iron, Nodular cast iron Grauguss GGG	Copper alloy Kupfer Leg	Aluminum alloy Alu Leg	Titanium alloy Titan Leg	Heat resist alloy warmfeste Leg
		~40HRC	~50HRC	~55HRC	~68HRC						
✓	✓	✓	✓			✓	✓				

Code key B252-B254
ISO Kennzeichen

Cutting data B374-B376
Schnittdaten

Graphics identification & application B253-B255
Graphische Werkzeug- & Anwendungsbeschr.

Order form for non-standard products B534-B535
Bestellformular für Sonderwerkzeuge

Milling · Fräsen

Solid Carbide end mills · Vollhartmetallschaftfräser

GM-2BL series for general machining · GM-2BL Serie für allgemeine Bearbeitung

2-flute ball nose end mills with with straight shank and long cutting edge
2-Schneiden Kugelnkopfräser mit langer Schneide und Zylinderschaft

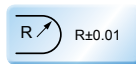
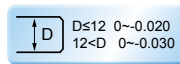
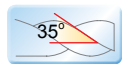
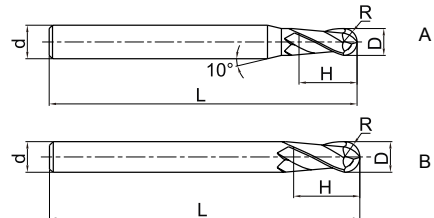

Type Typ	Dimension(mm) Abmessungen					Teeth Zähne Z	Geometry Ausführung	Grade Sorte KMG 303
	D	R	d	H	L			
GM-2BL-R1.0	2.0	1.0	6.0	4.0	75	2	A	●
GM-2BL-R1.25	2.5	1.25	6.0	5.0	75	2	A	●
GM-2BL-R1.5	3.0	1.5	6.0	6.0	75	2	A	●
GM-2BL-R1.75	3.5	1.75	6.0	8.0	75	2	A	●
GM-2BL-R2.0	4.0	2.0	6.0	8.0	75	2	A	●
GM-2BL-R2.5	5.0	2.5	6.0	10.0	75	2	A	●
GM-2BL-R2.75	5.5	2.75	6.0	12.0	75	2	A	●
GM-2BL-R3.0	6.0	3.0	6.0	12.0	75	2	B	●
GM-2BL-R3.5	7.0	3.5	8.0	14.0	75	2	A	●
GM-2BL-R4.0	8.0	4.0	8.0	16.0	100	2	B	●
GM-2BL-R4.5	9.0	4.5	10.0	18.0	100	2	A	●
GM-2BL-R5.0	10.0	5.0	10.0	20.0	100	2	B	●
GM-2BL-R6.0	12.0	6.0	12.0	24.0	100	2	B	●
GM-2BL-R7.0	14.0	7.0	14.0	28.0	100	2	B	●
GM-2BL-R8.0	16.0	8.0	16.0	32.0	150	2	B	●
GM-2BL-R10.0	20.0	10.0	20.0	40.0	150	2	B	●

Material Overview · Material Übersicht

✓ = Very suitable · Sehr empfohlen
✓ = Suitable · Empfohlen

KMG303

Workpiece material Werkstückstoff											
Carbon steel Kohlenstoff Stahl	Alloy steel Legierter Stahl	Quenched and tempered steel · Vergüteter Stahl		Hardened steel · Gehärteter Stahl		Stainless steel · Rostfreier Stahl	Cast iron, Nodular cast iron Grauguss GGG	Copper alloy Kupfer Leg	Aluminum alloy Alu Leg	Titanium alloy Titan Leg	Heat resist alloy warmfeste Leg
		~40HRC	~50HRC	~55HRC	~68HRC						
✓	✓	✓	✓			✓	✓				

● Ex Stock / ab Lager ○ On demand / auf Anfrage

GM-2BFP

2-flute straight shank ball nose end mills with short cutting edge and long neck
2-Schneiden Kugelpkopfräser mit kurzer Schneide und Zylinderschaft





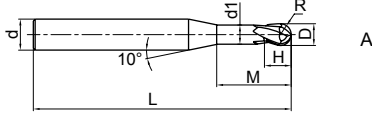

A

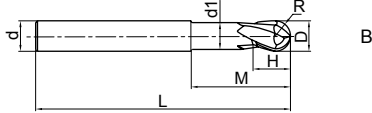

B

35°

Coated
TiAlN

D D≤12 0~-0.020
12<D 0~-0.030

R R±0.01

Type Typ	Dimension(mm) Abmessungen							Teeth Zähne Z	Geometry Ausführung	Grade Sorte KMG 303
	D	R	H	d1	M	d	L			
GM-2BFP-R0.5	1.0	0.5	1	0.95	2.5	6	75	2	A	○
GM-2BFP-R0.75	1.5	0.75	1	1.45	3	6	75	2	A	○
GM-2BFP-R1.0	2.0	1.0	2	1.95	4	6	75	2	A	●
GM-2BFP-R1.5	3.0	1.5	3	2.85	6	6	75	2	A	○
GM-2BFP-R2.0	4.0	2.0	4	3.85	8	6	75	2	A	○
GM-2BFP-R2.5	5.0	2.5	5	4.85	10	6	75	2	A	○
GM-2BFP-R3.0	6.0	3.0	6	5.8	12	6	75	2	B	○
GM-2BFP-R4.0	8.0	4.0	8	7.8	16	8	100	2	B	○
GM-2BFP-R5.0	10.0	5.0	10	9.6	20	10	100	2	B	○
GM-2BFP-R6.0	12.0	6.0	12	11.5	24	12	100	2	B	○
GM-2BFP-R8.0	16.0	8.0	16	15.5	32	16	150	2	B	○
GM-2BFP-R10.0	20.0	10.0	20	19.5	40	20	150	2	B	○

B

Solid Carbide end mills
Vollhartmetallschaftfräser

Material Overview · Material Übersicht

✓ = Very suitable · Sehr empfohlen
✓ = Suitable · Empfohlen

KMG303

Workpiece material Werkstückstoff											
Carbon steel Kohlenstoff Stahl	Alloy steel Legierter Stahl	Quenched and tempered steel · Vergüteter Stahl		Hardened steel · Gehärteter Stahl		Stainless steel · Rostfreier Stahl	Cast iron, Nodular cast iron Grauguss GGG	Copper alloy Kupfer Leg	Aluminum alloy Alu Leg	Titanium alloy Titan Leg	Heat resist alloy warmfeste Leg
		~40HRC	~50HRC	~55HRC	~68HRC						
✓	✓	✓	✓			✓	✓				

Code key **B252-B254**
ISO Kennzeichen

Cutting data **B374-B376**
Schnittdaten

Graphics identification & application **B253-B255**
Graphische Werkzeug- & Anwendungsbeschr.

Order form for non-standard products **B534-B535**
Bestellformular für Sonderwerkzeuge

Milling - Fräsen

Solid Carbide end mills - Vollhartmetallschaftfräser

Recommended cutting data - Empfohlene Schnittdaten

Type Typ	Grade Sorte	Material Werkstoffe	d ₁ (mm)	z	V _c (m/min)	f _z (mm/z)	a _p (mm)	a _e (mm)	d _{eff} (mm)	n (min ⁻¹)	V _f (mm/min)	
5565R302GF	KMG303	Steel Stahl HRC=24-30	3.00	2	225	0.060	0.09	0.18	1.02			
5665R202GM	KMG303		4.00	2	225	0.080	0.12	0.24	1.36			
			5.00	2	225	0.100	0.15	0.30	1.71			
			6.00	2	225	0.120	0.18	0.36	2.05			
			8.00	2	225	0.120	0.24	0.48	2.73			
			10.00	2	225	0.150	0.30	0.60	3.41			
			12.00	2	225	0.180	0.36	0.72	4.09			
			16.00	2	225	0.160	0.48	0.96	5.46			
			Steel Stahl HRC=30-42	3.00	2	200	0.060	0.09	0.18	1.02		
				4.00	2	200	0.080	0.12	0.24	1.36		
				5.00	2	200	0.100	0.15	0.30	1.71		
				6.00	2	200	0.120	0.18	0.36	2.05		
				8.00	2	200	0.120	0.24	0.48	2.73		
				10.00	2	200	0.150	0.30	0.60	3.41		
		12.00		2	200	0.180	0.36	0.72	4.09			
		Steel Stahl HRC=42-48	3.00	2	180	0.060	0.09	0.18	1.02			
			4.00	2	180	0.080	0.12	0.24	1.36			
			5.00	2	180	0.100	0.15	0.30	1.71			
			6.00	2	180	0.120	0.18	0.36	2.05			
			8.00	2	180	0.120	0.24	0.48	2.73			
			10.00	2	180	0.150	0.30	0.60	3.41			
			12.00	2	180	0.180	0.36	0.72	4.09			
		Cast iron Guss	3.00	2	250	0.060	0.09	0.18	1.02			
			4.00	2	250	0.080	0.12	0.24	1.36			
			5.00	2	250	0.100	0.15	0.30	1.71			
			6.00	2	250	0.120	0.18	0.36	2.05			
			8.00	2	250	0.120	0.24	0.48	2.73			
			10.00	2	250	0.150	0.30	0.60	3.41			
			12.00	2	250	0.180	0.36	0.72	4.09			
			16.00	2	250	0.160	0.48	0.96	5.46			

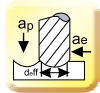



- Please start a test cutting with 85% of the V_c or 75% of the f_z, then increase the cutting speed and feed rate.
 - Please use high precision and high rigidity clamping system. The oscillation of the tool can not be over 0.01 mm.
- $N = 1000V_c / d_{eff} / 3.14159$
- When the rotating speed of the machine on site cannot reach the maximum rotation speed of the machine used for the calculation of the rotating speed: $V_f = f_z * n * z$ (n: actual rotation of the machine).

- Bitte führen Sie einen Testschnitt mit 85% der V_c und 75% des f_z durch.
 - Nach erfolgreichem Test können Sie die Schnittgeschwindigkeit bzw. die Vorschubwerte entsprechend erhöhen.
 - Bitte verwenden Sie nur Spannmittel mit einer hohen Genauigkeit und einer hohen Spannkraft.
 - Überprüfen Sie den Rundlauf der Werkzeuge. Sie sollten darauf achten, dass der Rundlauffehler nicht größer als 0.01 mm ist.
- $N = 1000V_c / d_{eff} / 3.14159$
- Sollten Sie aufgrund der Machinendrehzahl nicht in der Lage sein, die angegebenen Drehzahlen ein zuhalten, achten Sie darauf, dass Sie die V_f entsprechend anpassen. $V_f = f_z * n * z$ (n: aktuelle Machinendrehzahl).

B

Solid Carbide end mills
Vollhartmetallschaftfräser

Recommended cutting data · Empfohlene Schnittdaten

Type Typ	Grade Sorte	Material Werkstoffe	d ₁ (mm)	z	V _c (m/min)	f _z (mm/z)	a _p (mm)	a _e (mm)	d _{eff} (mm)	n (min ⁻¹)	V _f (mm/min)		
5566R302GF  	KMG303	P Steel Stahl HRC=24-30	3.00	2	215	0.060	0.06	0.18	0.84				
			4.00	2	215	0.080	0.08	0.24	1.12				
			5.00	2	215	0.100	0.10	0.30	1.40				
			6.00	2	215	0.120	0.12	0.36	1.68				
			8.00	2	215	0.120	0.16	0.48	2.24				
			10.00	2	215	0.150	0.20	0.60	2.80				
			12.00	2	215	0.180	0.24	0.72	3.36				
			3.00	2	190	0.060	0.06	0.18	0.84				
			4.00	2	190	0.080	0.08	0.24	1.12				
			5.00	2	190	0.100	0.10	0.30	1.40				
			6.00	2	190	0.120	0.12	0.36	1.68				
			8.00	2	190	0.120	0.16	0.48	2.24				
		10.00	2	190	0.150	0.20	0.60	2.80					
		12.00	2	190	0.180	0.24	0.72	3.36					
		3.00	2	160	0.060	0.06	0.18	0.84					
		4.00	2	160	0.080	0.08	0.24	1.12					
		5.00	2	160	0.100	0.10	0.30	1.40					
		6.00	2	160	0.120	0.12	0.36	1.68					
		8.00	2	160	0.120	0.16	0.48	2.24					
		10.00	2	160	0.150	0.20	0.60	2.80					
		12.00	2	160	0.180	0.24	0.72	3.36					
				K Cast iron Guss	3.00	2	230	0.060	0.06	0.18	0.84		
					4.00	2	230	0.080	0.08	0.24	1.12		
					5.00	2	230	0.100	0.10	0.30	1.40		
		6.00	2		230	0.120	0.12	0.36	1.68				
		8.00	2		230	0.120	0.16	0.48	2.24				
		10.00	2		230	0.150	0.20	0.60	2.80				
		12.00	2	230	0.180	0.24	0.72	3.36					

- Please start a test cutting with 85% of the V_c or 75% of the f_z, then increase the cutting speed and feed rate.
- Please use high precision and high rigidity clamping system. The oscillation of the tool can not be over 0.01 mm.
 $N = 1000V_c / d_{eff} / 3.14159$
 When the rotating speed of the machine on site cannot reach the maximum rotation speed of the machine used for the calculation of the rotating speed: $V_f = f_z * n * z$ (n: actual rotation of the machine).

- Bitte führen Sie einen Testschnitt mit 85% der V_c und 75% des f_z durch.
 Nach erfolgtem Test können Sie die Schnittgeschwindigkeit bzw. die Vorschubwerte entsprechend erhöhen.
- Bitte verwenden Sie nur Spannmittel mit einer hohen Genauigkeit und einer hohen Spannkraft.
 Überprüfen Sie den Rundlauf der Werkzeuge. Sie sollten darauf achten, dass der Rundlauffehler nicht größer als 0.01 mm ist.
 $N = 1000V_c / d_{eff} / 3.14159$
 Sollten Sie aufgrund der Machinendrehzahl nicht in der Lage sein, die angegebenen Drehzahlen einzuhalten, achten Sie darauf, dass Sie die V_f entsprechend anpassen. $V_f = f_z * n * z$ (n: aktuelle Machinendrehzahl).

Milling · Fräsen

Solid Carbide end mills · Vollhartmetallschaftfräser

Recommended cutting data · Empfohlene Schnittdaten

GM-2B | GM-2BL

Workpiece material Werkstückstoff	Cast iron, Nodular cast iron Grauguss GGG		Carbon steel, Alloy steel Kohlenstoffstahl Leg. Stahl ~750N/mm ²		Carbon steel, Alloy steel Kohlenstoffstahl Leg. Stahl ~30HRC		Pre-hardened steel, Quenched and tempered steel Vergüteter Stahl ~40HRC		Stainless steel Rostfreier Stahl		Pre-hardened steel, Quenched and tempered steel Vergüteter Stahl ~50HRC	
	Diameter Ø Durchmesser (mm)	Rotating Drehzahl (min ⁻¹)	Feed Vorschub (mm/min)	Rotating Drehzahl (min ⁻¹)	Feed Vorschub (mm/min)	Rotating Drehzahl (min ⁻¹)	Feed Vorschub (mm/min)	Rotating Drehzahl (min ⁻¹)	Feed Vorschub (mm/min)	Rotating Drehzahl (min ⁻¹)	Feed Vorschub (mm/min)	Rotating Drehzahl (min ⁻¹)
R0.5	40000	800	40000	800	38000	700	32000	320	22300	200	25000	275
R1.0	24000	900	24000	900	19000	760	16000	400	11150	230	13000	275
R1.5	15500	950	15500	950	12750	760	10600	450	7400	290	8500	280
R2.0	11500	950	11500	950	9550	760	8000	550	5550	370	6500	370
R2.5	9500	1050	9500	1050	7650	800	6400	550	4450	370	5000	375
R3.0	8000	1050	8000	1050	6400	800	5300	580	3700	390	4200	390
R4.0	6000	1300	6000	1300	4800	950	4000	700	2750	455	3200	440
R5.0	4800	1200	4800	1200	3800	900	3200	650	2200	430	2500	440
R6.0	4000	1100	4000	1100	3200	840	2650	610	1850	430	2100	420
R8.0	3000	1050	3000	1050	2400	800	2000	600	1350	380	1600	375
R10.0	2400	950	2400	950	1900	680	1600	560	1100	370	1250	330
Max. cutting depth max Schnitttiefe												

1. Please select high precise machine and tool holder.
2. Please use air blow or cutting liquid with high mist retardant property.
3. Vibration and unusual noise may be generated if the machine rigidity and workpiece fixture stability is low, please reduce the rotating speed and feed rate like mentioned above.
4. Make overhang as short as possible if no interference.

1. Bitte präzise Maschine und Werkzeugaufnahmen wählen.
2. Als Kühlmittel bitte Luft oder MQL (Minimalmengen) verwenden.
3. Bei Vibrationen oder unüblichen Geräuschen reduzieren Sie die Schnittdaten (wie oben empfohlen) entsprechend.
4. Werkzeugauskragung so kurz wie möglich wählen.

● Ex Stock / ab Lager ○ On demand / auf Anfrage

GM-2BS series for general machining · GM-2BS Serie für allgemeine Bearbeitung

2-flute tiny ball nose end mills with straight shank
2-Schneiden Micro-Kugelnkopffräser mit Zylinderschaft

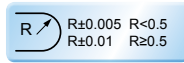
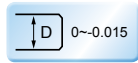
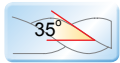
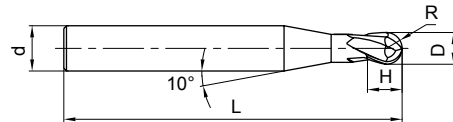

Type Typ	Dimension(mm) Abmessungen					Teeth Zähne Z	Grade Sorte KMG 303
	D	R	d	H	L		
GM-2BS-R0.15	0.30	0.15	4.0	0.5	50	2	●
GM-2BS-R0.20	0.40	0.20	4.0	0.6	50	2	●
GM-2BS-R0.25	0.50	0.25	4.0	0.8	50	2	●
GM-2BS-R0.30	0.60	0.30	4.0	0.9	50	2	●
GM-2BS-R0.35	0.70	0.35	4.0	1.0	50	2	●
GM-2BS-R0.40	0.80	0.40	4.0	1.2	50	2	●
GM-2BS-R0.45	0.90	0.45	4.0	1.3	50	2	●
GM-2BS-R0.50	1.00	0.50	4.0	1.5	50	2	●
GM-2BS-R0.60	1.20	0.60	4.0	1.8	50	2	●
GM-2BS-R0.70	1.40	0.70	4.0	2.0	50	2	●
GM-2BS-R0.75	1.50	0.75	4.0	2.3	50	2	●
GM-2BS-R0.80	1.60	0.80	4.0	2.5	50	2	●
GM-2BS-R0.90	1.80	0.90	4.0	2.7	50	2	●
GM-2BS-R1.00	2.00	1.00	4.0	3.0	50	2	●
GM-2BS-R1.25	2.50	1.25	4.0	3.7	50	2	●
GM-2BS-R1.50	3.00	1.50	4.0	4.5	50	2	●

B

Solid Carbide end mills
Vollhartmetallschaftfräser

Material Overview · Material Übersicht

✓ = Very suitable · Sehr empfohlen
✓ = Suitable · Empfohlen

KMG303

Workpiece material Werkstückstoff											
Carbon steel Kohlenstoff Stahl	Alloy steel Legierter Stahl	Quenched and tempered steel · Vergüteter Stahl		Hardened steel · Gehärteter Stahl		Stainless steel · Rostfreier Stahl	Cast iron, Nodular cast iron Grauguss GGG	Copper alloy Kupfer Leg	Aluminum alloy Alu Leg	Titanium alloy Titan Leg	Heat resist alloy warmfeste Leg
		~40HRC	~50HRC	~55HRC	~68HRC						
✓	✓	✓	✓			✓	✓				

Code key B252-B254
ISO Kennzeichen

Cutting data B380-B382
Schnittdaten

Graphics identification & application B253-B255
Graphische Werkzeug- & Anwendungsbeschr.

Order form for non-standard products B534-B535
Bestellformular für Sonderwerkzeuge

Milling · Fräsen

Solid Carbide end mills · Vollhartmetallschaftfräser

GM-2BP series for general machining · GM-2BP Serie für allgemeine Bearbeitung

2-flute ball nose end mills with short cutting edge and long neck
2-Schneiden Kugelkopffräser mit kurzer Schneide und Zylinderschaft

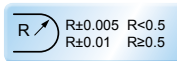
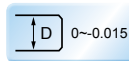
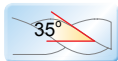
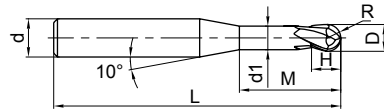

Type Typ	Dimension(mm) Abmessungen							Teeth Zähne Z	Grade Sorte KMG 303
	D	R	H	d ₁	M	d	L		
GM-2BP-R0.25-M04	0.5	0.25	0.7	0.45	4.0	4.0	50	2	●
GM-2BP-R0.25-M06	0.5	0.25	0.7	0.45	6.0	4.0	50	2	●
GM-2BP-R0.3-M04	0.6	0.3	0.9	0.55	4.0	4.0	50	2	●
GM-2BP-R0.3-M06	0.6	0.3	0.9	0.55	6.0	4.0	50	2	●
GM-2BP-R0.3-M08	0.6	0.3	0.9	0.55	8.0	4.0	50	2	●
GM-2BP-R0.4-M04	0.8	0.4	1.2	0.75	4.0	4.0	50	2	●
GM-2BP-R0.4-M06	0.8	0.4	1.2	0.75	6.0	4.0	50	2	●
GM-2BP-R0.4-M08	0.8	0.4	1.2	0.75	8.0	4.0	50	2	●
GM-2BP-R0.4-M10	0.8	0.4	1.2	0.75	10.0	4.0	50	2	●
GM-2BP-R0.5-M04	1.0	0.5	1.5	0.95	4.0	4.0	50	2	●
GM-2BP-R0.5-M06	1.0	0.5	1.5	0.95	6.0	4.0	50	2	●
GM-2BP-R0.5-M08	1.0	0.5	1.5	0.95	8.0	4.0	50	2	●
GM-2BP-R0.5-M10	1.0	0.5	1.5	0.95	10.0	4.0	50	2	●
GM-2BP-R0.5-M12	1.0	0.5	1.5	0.95	12.0	4.0	50	2	●
GM-2BP-R0.6-M06	1.2	0.6	1.8	1.15	6.0	4.0	50	2	●
GM-2BP-R0.6-M08	1.2	0.6	1.8	1.15	8.0	4.0	50	2	●
GM-2BP-R0.6-M12	1.2	0.6	1.8	1.15	12.0	4.0	50	2	●
GM-2BP-R0.6-M16	1.2	0.6	1.8	1.15	16.0	4.0	50	2	●
GM-2BP-R0.75-M08	1.5	0.75	2.3	1.45	8.0	4.0	50	2	●
GM-2BP-R0.75-M12	1.5	0.75	2.3	1.45	12.0	4.0	50	2	●
GM-2BP-R0.75-M16	1.5	0.75	2.3	1.45	16.0	4.0	50	2	●
GM-2BP-R1.0-M06	2.0	1.0	3.0	1.95	6.0	4.0	50	2	●
GM-2BP-R1.0-M08	2.0	1.0	3.0	1.95	8.0	4.0	50	2	●
GM-2BP-R1.0-M10	2.0	1.0	3.0	1.95	10.0	4.0	50	2	●
GM-2BP-R1.0-M12	2.0	1.0	3.0	1.95	12.0	4.0	50	2	●
GM-2BP-R1.0-M16	2.0	1.0	3.0	1.95	16.0	4.0	50	2	●
GM-2BP-R1.0-M20	2.0	1.0	3.0	1.95	20.0	4.0	50	2	●
GM-2BP-R1.25-M08	2.5	1.25	3.7	2.4	8.0	4.0	50	2	●
GM-2BP-R1.25-M12	2.5	1.25	3.7	2.4	12.0	4.0	50	2	●
GM-2BP-R1.25-M16	2.5	1.25	3.7	2.4	16.0	4.0	60	2	●
GM-2BP-R1.25-M20	2.5	1.25	3.7	2.4	20.0	4.0	60	2	●

● Ex Stock / ab Lager ○ On demand / auf Anfrage

GM-2BP series for general machining · GM-2BP Serie für allgemeine Bearbeitung

2-flute straight shank ball nose end mills with short cutting edge and long neck
 2-Schneiden Kugelkopffräser mit kurzer Schneide und Zylinderschaft

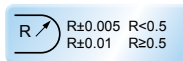
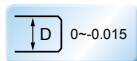
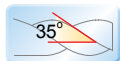
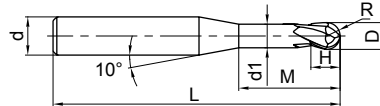

Type Typ	Dimension(mm) Abmessungen							Teeth Zähne Z	Grade Sorte KMG 303
	D	R	H	d ₁	M	d	L		
GM-2BP-R1.5-M08	3.0	1.5	4.5	2.85	8.0	6.0	50	2	●
GM-2BP-R1.5-M10	3.0	1.5	4.5	2.85	10.0	6.0	50	2	●
GM-2BP-R1.5-M12	3.0	1.5	4.5	2.85	12.0	6.0	50	2	●
GM-2BP-R1.5-M16	3.0	1.5	4.5	2.85	16.0	6.0	60	2	●
GM-2BP-R1.5-M20	3.0	1.5	4.5	2.85	20.0	6.0	60	2	●
GM-2BP-R2.0-M10	4.0	2.0	6.0	3.85	10.0	6.0	60	2	●
GM-2BP-R2.0-M16	4.0	2.0	6.0	3.85	16.0	6.0	60	2	●
GM-2BP-R2.0-M20	4.0	2.0	6.0	3.85	20.0	6.0	60	2	●
GM-2BP-R2.0-M25	4.0	2.0	6.0	3.85	25.0	6.0	60	2	●
GM-2BP-R2.5-M16	5.0	2.5	7.5	4.85	16.0	6.0	60	2	●
GM-2BP-R2.5-M25	5.0	2.5	7.5	4.85	25.0	6.0	70	2	●

B

Solid Carbide end mills
Vollhartmetallschaftfräser

Material Overview · Material Übersicht

✓ = Very suitable · Sehr empfohlen
 ✓ = Suitable · Empfohlen

KMG303

Workpiece material Werkstückstoff											
Carbon steel Kohlenstoff Stahl	Alloy steel Legierter Stahl	Quenched and tempered steel · Vergüteter Stahl		Hardened steel · Gehärteter Stahl		Stainless steel · Rostfreier Stahl	Cast iron, Nodular cast iron Grauguss GGG	Copper alloy Kupfer Leg	Aluminum alloy Alu Leg	Titanium alloy Titan Leg	Heat resist alloy warmfeste Leg
		~40HRC	~50HRC	~55HRC	~68HRC						
✓	✓	✓				✓	✓				

Code key B252,B254
ISO Kennzeichen

Cutting data B380-B382
Schnittdaten

Graphics identification & application B253-B255
Graphische Werkzeug- & Anwendungsbeschr.

Order form for non-standard products B534-B535
Bestellformular für Sonderwerkzeuge

Milling · Fräsen

Solid Carbide end mills · Vollhartmetallschaftfräser

Recommended cutting data · Empfohlene Schnittdaten

GM-2BS

Workpiece material Werkstückstoff	Cast iron, Nodular cast iron Grauguss GGG		Carbon steel, Alloy steel Kohlenstoffstahl Leg. Stahl ~750N/mm ²		Carbon steel, Alloy steel Kohlenstoffstahl Leg. Stahl ~30HRC		Pre-hardened steel, Quenched and tempered steel Vergüteter Stahl ~40HRC		Stainless steel Rostfreier Stahl	
	Rotating Drehzahl (min ⁻¹)	Feed Vorschub (mm/min)	Rotating Drehzahl (min ⁻¹)	Feed Vorschub (mm/min)	Rotating Drehzahl (min ⁻¹)	Feed Vorschub (mm/min)	Rotating Drehzahl (min ⁻¹)	Feed Vorschub (mm/min)	Rotating Drehzahl (min ⁻¹)	Feed Vorschub (mm/min)
R0.15	32000	300	32000	300	32000	270	32000	250	32000	150
R0.2	32000	380	32000	380	32000	320	32000	300	32000	175
R0.25	32000	460	32000	460	32000	410	32000	330	32000	205
R0.3	32000	535	32000	535	32000	500	32000	420	32000	265
R0.35	32000	550	32000	550	32000	520	32000	440	32000	270
R0.4	32000	610	32000	610	32000	560	32000	460	27500	285
R0.45	32000	700	32000	700	32000	600	25000	400	27500	285
R0.5	32000	765	32000	765	32000	640	25000	400	22000	285
R1.0	24000	900	24000	900	19000	760	16000	400	11150	230
R1.5	15500	950	15500	950	12750	760	10600	450	7400	290

Max. cutting depth max Schnitttiefe	Milling slot · Nutenfräsen		
	Ø	Ap	Ae
	D < Ø1	0.05R	0.2R
Ø1 ≤ D ≤ Ø3	0.1R	0.2R	

1. Please select high precise machine and tool holder.
2. Please use air blow or cutting liquid with high mist retardant property.
3. Make overhang as short as possible if no interference.
4. Reduce feed correspondingly when rotating speed is low.

1. Bitte präzise Maschine und Werkzeugaufnahmen wählen
2. Als Kühlmittel bitte Luft oder MQL (Minimalmengen) verwenden.
3. Werkzeugauskragung so kurz wie möglich wählen.
4. Bitte Vorschub entsprechend reduzieren, wenn die Drehzahlen niedrig sind.

B

Solid Carbide end mills
Vollhartmetallschaftfräser

Recommended cutting data · Empfohlene Schnittdaten

GM-2BP | GM-2BFP

Workpiece material Werkstückmaterial		Cast iron, Carbon steel, Alloy steel Kohlenstoffstahl Leg. Stahl ~750N/mm ²				Carbon steel, Alloy steel Kohlenstoffstahl Leg. Stahl ~30HRC				Pre-hardened steel, Quenched and tempered steel Vergüteter Stahl ~40HRC				Stainless steel · Rostfreier Stahl			
Diameter Durchmesser Ø (mm)	Effective length Effektive Länge (mm)	Rotating Drehzahl (min ⁻¹)	Feed Vorschub (mm/min)	Ap (mm)	Ae (mm)	Rotating Drehzahl (min ⁻¹)	Feed Vorschub (mm/min)	Ap (mm)	Ae (mm)	Rotating Drehzahl (min ⁻¹)	Feed Vorschub (mm/min)	Ap (mm)	Ae (mm)	Rotating Drehzahl (min ⁻¹)	Feed Vorschub (mm/min)	Ap (mm)	Ae (mm)
R0.25	4	27000	400	0.02	0.025	27000	380	0.02	0.025	27000	300	0.02	0.025	27000	200	0.02	0.025
	6	21000	200	0.01	0.015	21000	180	0.01	0.015	21000	160	0.01	0.015	21000	150	0.01	0.015
R0.3	4	27000	400	0.03	0.12	27000	380	0.03	0.12	25000	250	0.03	0.12	24000	200	0.03	0.12
	6	25000	300	0.03	0.12	25000	280	0.03	0.12	20000	150	0.03	0.12	20000	140	0.03	0.12
	8	25000	240	0.03	0.12	25000	225	0.03	0.12	20000	120	0.03	0.12	20000	110	0.03	0.12
R0.4	4	27000	600	0.04	0.16	27000	550	0.04	0.16	23000	450	0.04	0.16	21000	300	0.04	0.16
	6	24000	400	0.04	0.12	24000	360	0.04	0.12	21000	250	0.04	0.12	19000	200	0.04	0.12
	8	22000	300	0.04	0.12	22000	270	0.04	0.12	19000	150	0.04	0.12	19000	140	0.04	0.12
	10	22000	270	0.03	0.09	22000	250	0.03	0.09	19000	135	0.03	0.09	19000	120	0.03	0.09
R0.5	4	28000	600	0.05	0.20	28000	550	0.05	0.20	25000	500	0.05	0.20	21000	300	0.05	0.20
	6	21000	400	0.05	0.20	21000	360	0.05	0.20	19000	300	0.05	0.20	16000	200	0.05	0.20
	8	21000	360	0.05	0.15	21000	320	0.05	0.15	19000	270	0.05	0.15	16000	180	0.05	0.15
	10	18000	300	0.03	0.10	18000	270	0.03	0.10	17000	200	0.03	0.10	14000	150	0.03	0.10
	12	18000	270	0.03	0.10	18000	250	0.03	0.10	17000	180	0.03	0.10	14000	135	0.03	0.10
R0.6	6	20000	600	0.06	0.24	20000	540	0.06	0.24	17000	300	0.06	0.24	14000	200	0.06	0.24
	8	20000	540	0.06	0.24	20000	500	0.06	0.24	17000	270	0.06	0.24	14000	170	0.06	0.24
	12	16000	300	0.06	0.18	16000	270	0.06	0.18	14000	200	0.06	0.18	11000	150	0.06	0.18
	16	16000	270	0.03	0.12	16000	230	0.03	0.12	14000	175	0.03	0.12	11000	135	0.03	0.12
R0.75	8	17000	600	0.08	0.30	17000	540	0.08	0.30	15000	300	0.08	0.30	12000	250	0.08	0.30
	12	17000	540	0.06	0.24	17000	500	0.06	0.24	15000	275	0.06	0.24	12000	225	0.06	0.24
	16	13000	300	0.04	0.16	13000	275	0.04	0.16	12000	200	0.04	0.16	9500	150	0.04	0.16
R1.0	6	16500	800	0.10	0.40	16500	750	0.10	0.40	16500	560	0.10	0.40	13500	450	0.10	0.40
	8	16500	800	0.10	0.32	16500	750	0.10	0.32	16500	560	0.10	0.32	13500	450	0.10	0.32
	10	14000	630	0.08	0.30	14000	600	0.08	0.30	13000	450	0.08	0.30	10000	270	0.08	0.30
	12	14000	630	0.06	0.30	14000	600	0.06	0.30	13000	450	0.06	0.30	10000	270	0.06	0.30
	16	14000	550	0.06	0.24	14000	530	0.06	0.24	13000	400	0.06	0.24	10000	270	0.06	0.24
	20	11000	360	0.06	0.16	11000	330	0.06	0.16	10000	225	0.06	0.16	8000	175	0.06	0.16

Max. cutting depth
max
Schnitttiefe

Milling · Fräsen

Solid Carbide end mills · Vollhartmetallschaftfräser

Recommended cutting data · Empfohlene Schnittdaten

GM-2BP | GM-2BFP

Workpiece material Werkstückmaterial		Cast iron, Carbon steel, Alloy steel Kohlenstoffstahl Leg. Stahl ~750N/mm ²				Carbon steel, Alloy steel Kohlenstoffstahl Leg. Stahl ~30HRC				Pre-hardened steel, Quenched and tempered steel Vergüteter Stahl ~40HRC				Stainless steel · Rostfreier Stahl			
Diameter Ø Durchmesser (mm)	Effective length Effektive Länge (mm)	Rotating Drehzahl (min ⁻¹)	Feed Vorschub (mm/min)	Ap (mm)	Ae (mm)	Rotating Drehzahl (min ⁻¹)	Feed Vorschub (mm/min)	Ap (mm)	Ae (mm)	Rotating Drehzahl (min ⁻¹)	Feed Vorschub (mm/min)	Ap (mm)	Ae (mm)	Rotating Drehzahl (min ⁻¹)	Feed Vorschub (mm/min)	Ap (mm)	Ae (mm)
R1.25	8	14000	800	0.10	0.32	14000	750	0.10	0.32	14000	560	0.10	0.32	12500	450	0.10	0.32
	12	13000	630	0.06	0.30	13000	600	0.06	0.30	12000	450	0.06	0.30	10000	270	0.06	0.30
	16	13000	550	0.06	0.24	13000	530	0.06	0.24	12000	400	0.06	0.24	10000	270	0.06	0.24
	20	10000	360	0.06	0.16	10000	330	0.06	0.16	8000	225	0.06	0.16	7000	175	0.06	0.16
R1.5	8	12000	800	0.20	0.40	12000	720	0.20	0.40	9500	600	0.20	0.40	7500	400	0.20	0.40
	10	12000	800	0.15	0.40	12000	720	0.15	0.40	9500	600	0.15	0.40	7500	400	0.15	0.40
	12	12000	720	0.15	0.40	12000	650	0.15	0.40	9500	540	0.15	0.40	7500	360	0.15	0.40
	16	10000	600	0.15	0.40	10000	540	0.15	0.40	8500	300	0.15	0.40	6500	250	0.15	0.40
	20	10000	600	0.10	0.32	10000	540	0.10	0.32	8500	300	0.10	0.32	6500	250	0.10	0.32
R2.0	10	9000	800	0.20	0.80	9000	720	0.20	0.80	7500	600	0.20	0.80	6000	400	0.20	0.80
	16	9000	800	0.20	0.60	9000	720	0.20	0.60	7500	600	0.20	0.60	6000	400	0.20	0.60
	20	7000	600	0.20	0.40	7000	540	0.20	0.40	6000	400	0.20	0.40	5000	250	0.20	0.40
	25	7000	600	0.15	0.40	7000	540	0.15	0.40	6000	400	0.15	0.40	5000	250	0.15	0.40
R2.5	16	7000	600	0.25	1.00	7000	540	0.25	1.00	6500	500	0.25	1.00	5000	400	0.25	1.00
	25	6000	500	0.25	1.00	6000	450	0.25	1.00	5000	500	0.25	1.00	4000	250	0.25	1.00
Max. cutting depth max Schnitttiefe																	

1. Please select high precise machine and tool holder.
2. Please use air blow or cutting liquid with high mist retardant property.
3. Make overhang as short as possible if no interference.
4. Reduce feed correspondingly when rotating speed is low.

1. Bitte präzise Maschine und Werkzeugaufnahmen wählen
2. Als Kühlmittel bitte Luft oder MQL (Minimalmengen) verwenden.
3. Werkzeugauskragung so kurz wie möglich halten.
4. Bitte Vorschub entsprechend reduzieren, wenn die Drehzahlen niedrig sind.

● Ex Stock / ab Lager ○ On demand / auf Anfrage

GM-4B series for general machining · GM-4B Serie für allgemeine Bearbeitung

4-flute ball nose end mills with straight shank
4-Schneiden Kugelnosefräser mit Zylinderschaft

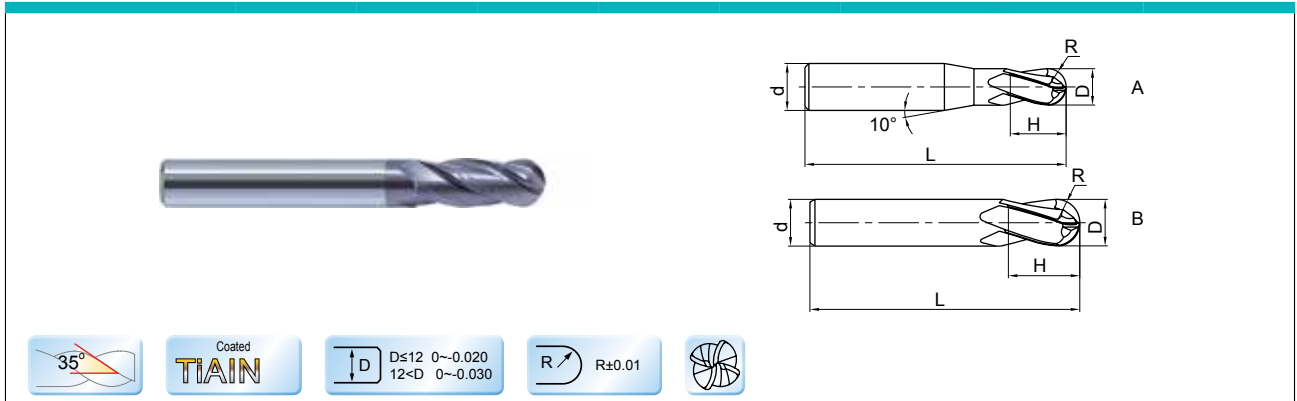

Type Typ	Dimension (mm) Abmessungen					Teeth Zähne Z	Geometry Ausführung	Grade Sorte KMG 303
	D	R	d	H	L			
GM-4B-R1.5	3.0	1.5	6.0	6.0	50	4	A	●
GM-4B-R2.0	4.0	2.0	6.0	8.0	50	4	A	●
GM-4B-R2.5	5.0	2.5	6.0	10.0	50	4	A	●
GM-4B-R3.0	6.0	3.0	6.0	12.0	50	4	B	●
GM-4B-R4.0	8.0	4.0	8.0	16.0	60	4	B	●
GM-4B-R5.0	10.0	5.0	10.0	20.0	75	4	B	●
GM-4B-R6.0	12.0	6.0	12.0	24.0	75	4	B	●
GM-4B-R7.0	14.0	7.0	14.0	28.0	75	4	B	●
GM-4B-R8.0	16.0	8.0	16.0	32.0	100	4	B	●
GM-4B-R9.0	18.0	9.0	18.0	36.0	100	4	B	●
GM-4B-R10.0	20.0	10.0	20.0	40.0	100	4	B	●

B

Solid Carbide end mills
Vollhartmetallschaftfräser

Material Overview · Material Übersicht

✓ = Very suitable · Sehr empfohlen
✓ = Suitable · Empfohlen

KMG303

Workpiece material Werkstückstoff											
Carbon steel Kohlenstoff Stahl	Alloy steel Legierter Stahl	Quenched and tempered steel · Vergüteter Stahl		Hardened steel · Gehärteter Stahl		Stainless steel · Rostfreier Stahl	Cast iron, Nodular cast iron Grauguss GGG	Copper alloy Kupfer Leg	Aluminum alloy Alu Leg	Titanium alloy Titan Leg	Heat resist alloy warmfeste Leg
		~40HRC	~50HRC	~55HRC	~68HRC						
✓	✓	✓	✓			✓	✓				

Code key B252,B254
ISO Kennzeichen

Cutting data B385
Schnittdaten

Graphics identification & application B253-B255
Graphische Werkzeug- & Anwendungsbeschr.

Order form for non-standard products B534-B535
Bestellformular für Sonderwerkzeuge

Milling · Fräsen

Solid Carbide end mills · Vollhartmetallschaftfräser

GM-4BL

4-flute ball nose end mills with with straight shank and long cutting edge
4-Schneiden Kugelnkopffräser mit langer Schneide und Zylinderschaft

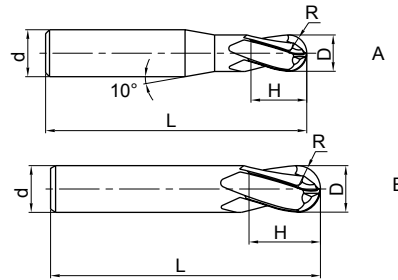

Type Typ	Dimension(mm) Abmessungen					Teeth Zähne Z	Geometry Ausführung	Grade Sorte KMG 303
	D	R	d	H	L			
GM-4BL-R1.5	3.0	1.5	6	6	75	4	A	●
GM-4BL-R2.0	4.0	2.0	6	8	75	4	A	●
GM-4BL-R2.5	5.0	2.5	6	10	75	4	A	●
GM-4BL-R3.0	6.0	3.0	6	12	75	4	B	●
GM-4BL-R4.0	8.0	4.0	8	16	100	4	B	●
GM-4BL-R5.0	10.0	5.0	10	20	100	4	B	●
GM-4BL-R6.0	12.0	6.0	12	24	100	4	B	●
GM-4BL-R7.0	14.0	7.0	14	28	100	4	B	●
GM-4BL-R8.0	16.0	8.0	16	32	150	4	B	●
GM-4BL-R9.0	18.0	9.0	18	36	150	4	B	●
GM-4BL-R10.0	20.0	10.0	20	40	150	4	B	●

Material Overview · Material Übersicht

✓ = Very suitable · Sehr empfohlen
✓ = Suitable · Empfohlen

KMG303

Workpiece material Werkstückstoff											
Carbon steel Kohlenstoff Stahl	Alloy steel Legierter Stahl	Quenched and tempered steel · Vergüteter Stahl		Hardened steel · Gehärteter Stahl		Stainless steel · Rostfreier Stahl	Cast iron, Nodular cast iron Grauguss GGG	Copper alloy Kupfer Leg	Aluminum alloy Alu Leg	Titanium alloy Titan Leg	Heat resist alloy warmfeste Leg
		~40HRC	~50HRC	~55HRC	~68HRC						
✓	✓	✓	✓			✓	✓				

● Ex Stock / ab Lager ○ On demand / auf Anfrage

Recommended cutting data · Empfohlene Schnittdaten

GM-4B | GM-4BL

Workpiece material Werkstückstoff	Cast iron, Nodular cast iron Grauguss GGG		Carbon steel, Alloy steel Kohlenstoffstahl Leg. Stahl ~750N/mm ²		Carbon steel, Alloy steel Kohlenstoffstahl Leg. Stahl ~30HRC		Pre-hardened steel, Quenched and tempered steel Vergüteter Stahl ~40HRC		Stainless steel Rostfreier Stahl		Pre-hardened steel, Quenched and tempered steel Vergüteter Stahl ~50HRC	
Cutting speed Schnittgeschw.	150 m/min		150m/min		120m/min		100m/min		70m/min		80m/min	
Diameter Ø Durchmesser (mm)	Rotating Drehzahl (min ⁻¹)	Feed Vorschub (mm/min)	Rotating Drehzahl (min ⁻¹)	Feed Vorschub (mm/min)	Rotating Drehzahl (min ⁻¹)	Feed Vorschub (mm/min)	Rotating Drehzahl (min ⁻¹)	Feed Vorschub (mm/min)	Rotating Drehzahl (min ⁻¹)	Feed Vorschub (mm/min)	Rotating Drehzahl (min ⁻¹)	Feed Vorschub (mm/min)
R1.5	15500	1710	15500	1710	12750	1340	10600	810	7400	520	8500	500
R2.0	11500	1710	11500	1710	9550	1340	8000	990	5550	660	6500	665
R2.5	9500	1890	9500	1890	7650	1440	6400	990	4450	660	5000	675
R3.0	8000	1890	8000	1890	6400	1440	5300	1040	3700	700	4200	700
R4.0	6000	2340	6000	2340	4800	1710	4000	1260	2750	820	3200	790
R5.0	4800	2160	4800	2160	3800	1620	3200	1170	2200	770	2500	790
R6.0	4000	1980	4000	1980	3200	1510	2650	1100	1850	770	2100	755
R8.0	3000	1890	3000	1890	2400	1440	2000	1080	1350	680	1600	675
R10.0	2400	1710	2400	1710	1900	1220	1600	1000	1100	660	1250	595
Max. cutting depth max Schnitttiefe												

1. Please select high precise machine and tool holder.
2. Please use air blow or cutting liquid with high mist retardant property.
3. Vibration and unusual noise may be generated if the machine rigidity and workpiece fixture stability is low, please reduce the rotating speed and feed rate like mentioned above.
4. Make overhang as short as possible if no interference.

1. Bitte präzise Maschine und Werkzeugaufnahmen wählen.
2. Als Kühlmittel bitte Luft oder MQL (Minimalmengen) verwenden..
3. Bei Vibrationen oder unüblichen Geräuschen reduzieren Sie die Schnittdaten (wie oben empfohlen) entsprechend.
4. Werkzeugauskragung so kurz wie möglich wählen.

Milling · Fräsen

Solid Carbide end mills · Vollhartmetallschaftfräser

GM-2R series for general machining · GM-2R Serie für allgemeine Bearbeitung

2-flute radius end mills with straight shank
2-Schneiden Radius-Schaftfräser und Zylinderschaft

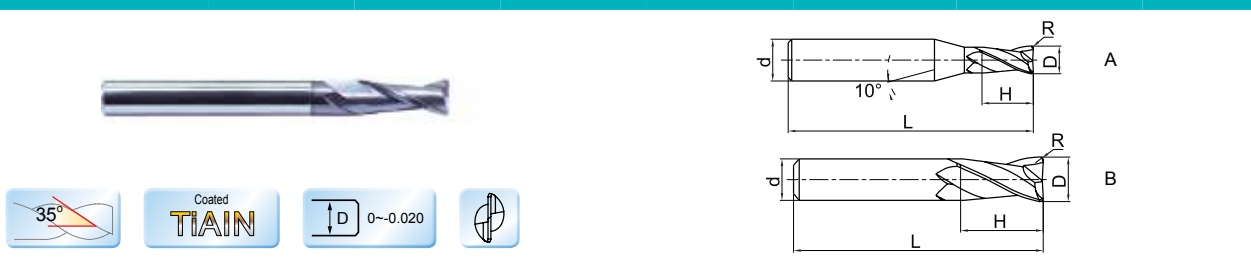
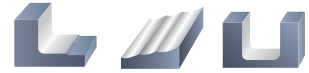

Type Typ	Dimension(mm) Abmessungen					Teeth Zähne Z	Grade Sorte KMG 303
	D	R	d	H	L		
GM-2R-D1.0R0.2	1.0	0.2	4	3	50	2	●
GM-2R-D1.5R0.2	1.5	0.2	4	4	50	2	●
GM-2R-D2.0R0.2	2.0	0.2	4	6	50	2	●
GM-2R-D2.0R0.5	2.0	0.5	4	6	50	2	●
GM-2R-D2.5R0.2	2.5	0.2	4	8	50	2	●
GM-2R-D2.5R0.5	2.5	0.5	4	8	50	2	●
GM-2R-D3.0R0.2	3.0	0.2	4	8	50	2	●
GM-2R-D3.0R0.3	3.0	0.3	4	8	50	2	●
GM-2R-D3.0R0.5	3.0	0.5	4	8	50	2	●
GM-2R-D4.0R0.2	4.0	0.2	4	11	50	2	●
GM-2R-D4.0R0.3	4.0	0.3	4	11	50	2	●
GM-2R-D4.0R0.5	4.0	0.5	4	11	50	2	●
GM-2R-D4.0R1.0	4.0	1.0	4	11	50	2	●
GM-2R-D5.0R0.3	5.0	0.3	6	13	50	2	●
GM-2R-D5.0R0.5	5.0	0.5	6	13	50	2	●
GM-2R-D5.0R1.0	5.0	1.0	6	13	50	2	●
GM-2R-D6.0R0.3	6.0	0.3	6	16	50	2	●
GM-2R-D6.0R0.5	6.0	0.5	6	16	50	2	●
GM-2R-D6.0R1.0	6.0	1.0	6	16	50	2	●
GM-2R-D8.0R0.3	8.0	0.3	8	20	60	2	●
GM-2R-D8.0R0.5	8.0	0.5	8	20	60	2	●
GM-2R-D8.0R1.0	8.0	1.0	8	20	60	2	●
GM-2R-D10.0R0.5	10.0	0.5	10	25	75	2	●
GM-2R-D10.0R1.0	10.0	1.0	10	25	75	2	●
GM-2R-D10.0R1.5	10.0	1.5	10	25	75	2	●
GM-2R-D10.0R2.0	10.0	2.0	10	25	75	2	●
GM-2R-D12.0R0.5	12.0	0.5	12	30	75	2	●
GM-2R-D12.0R1.0	12.0	1.0	12	30	75	2	●
GM-2R-D12.0R1.5	12.0	1.5	12	30	75	2	●
GM-2R-D12.0R2.0	12.0	2.0	12	30	75	2	●

Material Overview · Material Übersicht

✓ = Very suitable · Sehr empfohlen
✓ = Suitable · Empfohlen

KMG303

Workpiece material Werkstückstoff											
Carbon steel Kohlenstoff Stahl	Alloy steel Legierter Stahl	Quenched and tempered steel · Vergüteter Stahl		Hardened steel · Gehärteter Stahl		Stainless steel · Rostfreier Stahl	Cast iron, Nodular cast iron Grauguss GGG	Copper alloy Kupfer Leg	Aluminum alloy Alu Leg	Titanium alloy Titan Leg	Heat resist alloy warmfeste Leg
		~40HRC	~50HRC	~55HRC	~68HRC						
✓	✓	✓	✓			✓	✓			✓	✓

● Ex Stock / ab Lager ○ On demand / auf Anfrage

Recommended cutting data · Empfohlene Schnittdaten

GM-2R

Workpiece material Werkstückmaterial	Cast iron, Nodular cast iron Grauguss GGG		Carbon steel, Alloy steel Kohlenstoffstahl Leg. Stahl ~750N/mm ²		Carbon steel, Alloy steel Kohlenstoffstahl Leg. Stahl ~30HRC		Pre-hardened steel, Quenched and tempered steel Vergüteter Stahl ~40HRC		Stainless steel Rostfreier Stahl		Pre-hardened steel, Quenched and tempered steel Vergüteter Stahl ~50HRC	
	Diameter Ø Durchmesser (mm)	Rotating Drehzahl (min ⁻¹)	Feed Vorschub (mm/min)	Rotating Drehzahl (min ⁻¹)	Feed Vorschub (mm/min)	Rotating Drehzahl (min ⁻¹)	Feed Vorschub (mm/min)	Rotating Drehzahl (min ⁻¹)	Feed Vorschub (mm/min)	Rotating Drehzahl (min ⁻¹)	Feed Vorschub (mm/min)	Rotating Drehzahl (min ⁻¹)
1	20000	200	20000	200	20000	160	20000	160	20000	60	20000	120
2	15000	320	15000	320	15000	290	15000	280	11150	84	13000	180
3	14000	545	14000	545	13000	510	10600	420	7500	120	8500	330
4	10800	560	10800	560	10000	520	8000	430	5500	130	6500	335
5	8200	580	8200	580	7600	540	6400	450	4500	130	5000	355
6	7000	600	7000	600	6400	550	5300	460	3700	140	4200	360
8	5200	600	5200	600	4800	550	4000	460	2800	140	3200	365
10	4200	580	4200	580	3800	540	3200	445	2200	140	2500	350
12	3500	580	3500	580	3200	540	2650	445	1850	140	2100	350

Max. cutting depth max Schnitttiefe									
	<table border="1"> <thead> <tr> <th colspan="2">Milling slot · Nutenfräsen</th> </tr> <tr> <th>Ø</th> <th>Ap</th> </tr> </thead> <tbody> <tr> <td>Ø1 ≤ D < Ø3</td> <td>0.15D</td> </tr> <tr> <td>Ø3 ≤ D</td> <td>0.3D</td> </tr> </tbody> </table>	Milling slot · Nutenfräsen		Ø	Ap	Ø1 ≤ D < Ø3	0.15D	Ø3 ≤ D	0.3D
Milling slot · Nutenfräsen									
Ø	Ap								
Ø1 ≤ D < Ø3	0.15D								
Ø3 ≤ D	0.3D								

- The above table shows the standard value of side milling. When slot milling, of rotating speed 50%~70% and feed rate like mentioned above 40%~60%.
- Please select high precise machine and tool holder.
- Please use air blow or cutting liquid with high mist retardant property.
- Down milling is recommended in side milling.
- Vibration and unusual noise may be generated if the machine rigidity and workpiece fixture stability is low, please reduce the rotating speed and feed rate like mentioned above.
- Make overhang as short as possible if no interference.

- Die obige Tabelle zeigt Standard Werte für das Eckfräsen. Bei Nutenfräsen, Schnittgeschwindigkeit auf 50-70% und den Vorschub auf 40-60% reduzieren.
- Bitte präzise Maschinen und Werkzeughalter verwenden.
- Bitte Luftkühlung oder Schneidflüssigkeit benutzen.
- Empfohlene Fräsmethode: Gleichlaufräsen.
- Bei Vibrationen oder unüblichen Geräuschen reduzieren Sie die Schnittdaten (wie oben empfohlen) entsprechend.
- Werkzeugauskrägung so kurz wie möglich wählen.

Milling · Fräsen

Solid Carbide end mills · Vollhartmetallschaftfräser

GM-4R series for general machining · GM-4R Serie für allgemeine Bearbeitung

4-flute radius end mills with straight shank
4-Schneiden Radius-Schaftfräser und Zylinderschaft

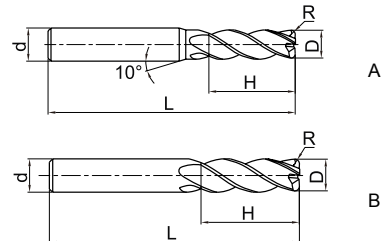

Type Typ	Dimension(mm) Abmessungen					Teeth Zähne Z	Geometry Ausführung	Grade Sorte KMG 303
	D	R	d	H	L			
GM-4R-D3.0R0.2	3.0	0.2	4	8	50	4	A	●
GM-4R-D4.0R0.3	4.0	0.3	4	10	50	4	B	●
GM-4R-D4.0R0.5	4.0	0.5	4	10	50	4	B	●
GM-4R-D5.0R0.5	5.0	0.5	6	13	50	4	A	●
GM-4R-D5.0R1.0	5.0	1.0	6	13	50	4	A	●
GM-4R-D6.0R0.5	6.0	0.5	6	16	50	4	B	●
GM-4R-D6.0R1.0	6.0	1.0	6	16	50	4	B	●
GM-4R-D8.0R0.5	8.0	0.5	8	20	60	4	B	●
GM-4R-D8.0R1.0	8.0	1.0	8	20	60	4	B	●
GM-4R-D10.0R0.5	10.0	0.5	10	25	75	4	B	●
GM-4R-D10.0R1.0	10.0	1.0	10	25	75	4	B	●
GM-4R-D10.0R2.0	10.0	2.0	10	25	75	4	B	●
GM-4R-D10.0R3.0	10.0	3.0	10	25	75	4	B	●
GM-4R-D12.0R0.5	12.0	0.5	12	30	75	4	B	●
GM-4R-D12.0R1.0	12.0	1.0	12	30	75	4	B	●
GM-4R-D12.0R2.0	12.0	2.0	12	30	75	4	B	●
GM-4R-D12.0R3.0	12.0	3.0	12	30	75	4	B	●

B

Solid Carbide end mills
Vollhartmetallschaftfräser

Material Overview · Material Übersicht

✓ = Very suitable · Sehr empfohlen
✓ = Suitable · Empfohlen

KMG303

		Workpiece material Werkstückstoff									
Carbon steel Kohlenstoff Stahl	Alloy steel Legierter Stahl	Quenched and tempered steel · Vergüteter Stahl		Hardened steel · Gehärteter Stahl		Stainless steel · Rostfreier Stahl	Cast iron, Nodular cast iron Grauguss GGG	Copper alloy Kupfer Leg	Aluminum alloy Alu Leg	Titanium alloy Titan Leg	Heat resist alloy warmfeste Leg
		~40HRC	~50HRC	~55HRC	~68HRC						
✓	✓	✓	✓			✓	✓			✓	✓

● Ex Stock / ab Lager ○ On demand / auf Anfrage

GM-4RL series for general machining · GM-4RL Serie für allgemeine Bearbeitung

4-flute radius end mills with straight shank
4-Schneiden Gesenkfräser mit Eckenradius u. Zylinderschaft

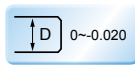
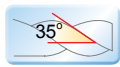
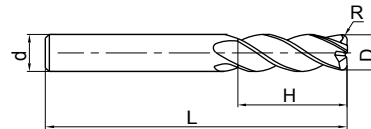

Type Typ	Dimension(mm) Abmessungen					Teeth Zähne Z	Grade Sorte KMG 303
	D	R	d	H	L		
GM-4RL-D6.0R0.5	6.0	0.5	6	16	75	4	●
GM-4RL-D6.0R1.0	6.0	1.0	6	16	75	4	●
GM-4RL-D8.0R0.5	8.0	0.5	8	20	100	4	●
GM-4RL-D8.0R1.0	8.0	1.0	8	20	100	4	●
GM-4RL-D10.0R0.5	10.0	0.5	10	25	100	4	●
GM-4RL-D10.0R1.0	10.0	1.0	10	25	100	4	●
GM-4RL-D10.0R2.0	10.0	2.0	10	25	100	4	●
GM-4RL-D12.0R0.5	12.0	0.5	12	30	100	4	●
GM-4RL-D12.0R1.0	12.0	1.0	12	30	100	4	●
GM-4RL-D12.0R2.0	12.0	2.0	12	30	100	4	●
GM-4RL-D16.0R1.0	16.0	1.0	16	45	150	4	●
GM-4RL-D16.0R2.0	16.0	2.0	16	45	150	4	●

B

Solid Carbide end mills
Vollhartmetallschaftfräser

Material Overview · Material Übersicht

✓ = Very suitable · Sehr empfohlen
✓ = Suitable · Empfohlen

KMG303

Workpiece material Werkstückstoff											
Carbon steel Kohlenstoff Stahl	Alloy steel Legierter Stahl	Quenched and tempered steel · Vergüteter Stahl		Hardened steel · Gehärteter Stahl		Stainless steel · Rostfreier Stahl	Cast iron, Nodular cast iron Grauguss GGG	Copper alloy Kupfer Leg	Aluminum alloy Alu Leg	Titanium alloy Titan Leg	Heat resist alloy warmfeste Leg
		~40HRC	~50HRC	~55HRC	~68HRC						
✓	✓	✓	✓			✓	✓			✓	✓

Code key B252,B254
ISO Kennzeichen

Cutting data B390
Schnittdaten

Graphics identification & application B253-B255
Graphische Werkzeug- & Anwendungsbeschr.

Order form for non-standard products B534-B535
Bestellformular für Sonderwerkzeuge

Milling - Fräsen

Solid Carbide end mills · Vollhartmetallschaftfräser

Recommended cutting data · Empfohlene Schnittdaten

GM-4R | GM-4RL

Workpiece material Werkstückmaterial	Cast iron, Nodular cast iron Grauguss GGG		Carbon steel, Alloy steel Kohlenstoffstahl Leg. Stahl ~750N/mm ²		Carbon steel, Alloy steel Kohlenstoffstahl Leg. Stahl ~30HRC		Pre-hardened steel, Quenched and tempered steel Vergüteter Stahl ~40HRC		Stainless steel Rostfreier Stahl		Pre-hardened steel, Quenched and tempered steel Vergüteter Stahl ~50HRC	
	Diameter Ø Durchmesser (mm)	Rotating Drehzahl (min ⁻¹)	Feed Vorschub (mm/min)	Rotating Drehzahl (min ⁻¹)	Feed Vorschub (mm/min)	Rotating Drehzahl (min ⁻¹)	Feed Vorschub (mm/min)	Rotating Drehzahl (min ⁻¹)	Feed Vorschub (mm/min)	Rotating Drehzahl (min ⁻¹)	Feed Vorschub (mm/min)	Rotating Drehzahl (min ⁻¹)
3	14000	820	14000	820	13000	755	10600	630	7500	145	8500	490
4	10800	840	10800	840	10000	770	8000	640	5500	145	6500	500
5	8200	880	8200	880	7600	810	6400	670	4500	145	5000	530
6	7000	900	7000	900	6400	830	5300	690	3700	160	4200	540
8	5200	890	5200	890	4800	815	4000	680	2800	160	3200	550
10	4200	880	4200	880	3800	810	3200	670	2200	160	2500	520
12	3500	880	3500	880	3200	810	2650	670	1850	160	2100	520
16	2600	680	2600	680	2400	630	2000	525	1400	120	1600	490

Max. cutting depth max Schnitttiefe									
	<table border="1"> <thead> <tr> <th colspan="2">Milling slot · Nutenfräsen</th> </tr> <tr> <th>Ø</th> <th>Ap</th> </tr> </thead> <tbody> <tr> <td>Ø1 ≤ D < Ø3</td> <td>0.15D</td> </tr> <tr> <td>Ø3 ≤ D</td> <td>0.3D</td> </tr> </tbody> </table>	Milling slot · Nutenfräsen		Ø	Ap	Ø1 ≤ D < Ø3	0.15D	Ø3 ≤ D	0.3D
Milling slot · Nutenfräsen									
Ø	Ap								
Ø1 ≤ D < Ø3	0.15D								
Ø3 ≤ D	0.3D								

- The above table shows the standard value of side milling. When slot milling, of rotating speed 50%~70% and feed rate like mentioned above 40%~60%.
- Please select high precise machine and tool holder.
- Please use air blow or cutting liquid with high mist retardant property.
- Down milling is recommended in side milling.
- Vibration and unusual noise may be generated if the machine rigidity and workpiece fixture stability is low, please reduce the rotating speed and feed rate like mentioned above.
- Make overhang as short as possible if no interference.

- Die obige Tabelle zeigt Standard Werte für das Eckfräsen. Bei Nutenfräsen, Schnittgeschwindigkeit auf 50-70% und den Vorschub auf 40-60% reduzieren.
- Bitte präzise Maschinen und Werkzeughalter verwenden.
- Bitte Luftkühlung oder Schneidflüssigkeit benutzen.
- Empfohlene Fräsmethode: Gleichlaufräsen.
- Bei Vibrationen oder unüblichen Geräuschen reduzieren Sie die Schnittdaten (wie oben empfohlen) entsprechend.
- Werkzeugauskragung so kurz wie möglich wählen.

● Ex Stock / ab Lager ○ On demand / auf Anfrage

DIN 6527L Roughing end mills · DIN 6527L VHM Schruppfräser

5602R303/304/305GR

KMG303: nano AlTiN coated Ultra-fine carbide / nano AlTiN beschichtetes Ultrafeinkornhartmetall

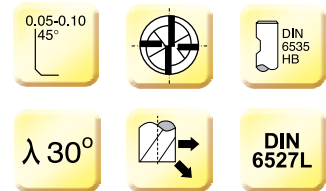
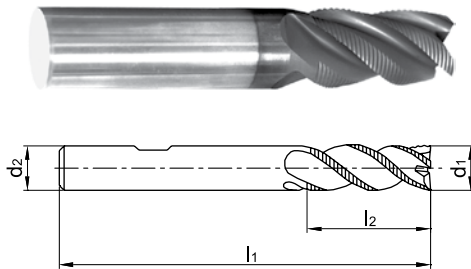

Type Typ	Dimension(mm) Abmessungen				Teeth Zähne	Application Anwendung	P K S		
	d1(e8)	d2(h6)	l2	l1			Grade Sorte		
5602R303GR-0600	6.00	6	13	57	3			●	
5602R303GR-0800	8.00	8	19	63	3			●	
5602R304GR-1000	10.00	10	22	72	4			●	
5602R304GR-1200	12.00	12	26	83	4			●	
5602R304GR-1400	14.00	14	30	90	4			○	
5602R304GR-1600	16.00	16	32	92	4			●	
5602R304GR-2000	20.00	20	38	104	4			●	
5602R305GR-2500	25.00	25	45	121	5			○	
Art. Group No. / Produktgruppe Nr. :							021130		

B

Solid Carbide end mills
Vollhartmetallschaftfräser

Material Overview · Material Übersicht

✓ = Very suitable · Sehr empfohlen
✓ = Suitable · Empfohlen

KMG303

Workpiece material Werkstückstoff											
Carbon steel Kohlenstoff Stahl	Alloy steel Legierter Stahl	Quenched and tempered steel · Vergüteter Stahl		Hardened steel · Gehärteter Stahl		Stainless steel · Rostfreier Stahl	Cast iron, Nodular cast iron Grauguss GGG	Copper alloy Kupfer Leg	Aluminum alloy Alu Leg	Titanium alloy Titan Leg	Heat resist alloy warmfeste Leg
		~40HRC	~50HRC	~55HRC	~68HRC						
✓	✓	✓	✓				✓			✓	✓

Code key B252, B254
ISO Kennzeichen

Cutting data B393-B395
Schnittdaten

Graphics identification & application B253-B255
Graphische Werkzeug- & Anwendungsbeschr.

Order form for non-standard products B534-B535
Bestellformular für Sonderwerkzeuge

B391

Milling · Fräsen

Solid Carbide end mills · Vollhartmetallschaftfräser

GM-4W series for general machining · **GM-4W** Serie für allgemeine Bearbeitung

4-flute end mills with straight shank for roughing
4-Schneiden Schruppfräser mit Zylinderschaft

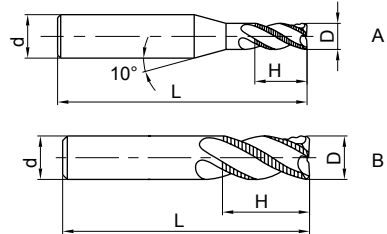
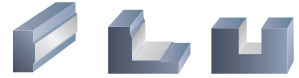

- Most suitable for effectively rough machining.
- Besonders empfohlen für die Schruppbearbeitung.

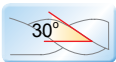

D ≤ 6	0 ~ -0.048	6 < D ≤ 10	0 ~ -0.058
10 < D ≤ 18	0 ~ -0.07	18 < D	0 ~ -0.084



Type Typ	Dimension (mm) Abmessungen				Teeth Zähne Z	Geometry Ausführung	Grade Sorte KMG 405
	D	d	H	L			
GM-4W-D6.0	6	6	16	50	4	B	●
GM-4W-D7.0	7	8	20	60	4	A	●
GM-4W-D8.0	8	8	20	60	4	B	●
GM-4W-D9.0	9	10	22	75	4	A	●
GM-4W-D10.0	10	10	25	75	4	B	●
GM-4W-D11.0	11	12	26	75	4	A	●
GM-4W-D12.0	12	12	30	75	4	B	●
GM-4W-D16.0	16	16	45	100	4	B	●
GM-4W-D20.0	20	20	45	100	4	B	●

B

Solid Carbide end mills
Vollhartmetallschaftfräser

Material Overview · Material Übersicht



✓ = Very suitable · Sehr empfohlen
✓ = Suitable · Empfohlen

KMG405

Workpiece material Werkstückstoff											
Carbon steel Kohlenstoff Stahl	Alloy steel Legierter Stahl	Quenched and tempered steel · Vergüteter Stahl		Hardened steel · Gehärteter Stahl		Stainless steel · Rostfreier Stahl	Cast iron, Nodular cast iron Grauguss GGG	Copper alloy Kupfer Leg	Aluminum alloy Alu Leg	Titanium alloy Titan Leg	Heat resist alloy warmfeste Leg
		~40HRC	~50HRC	~55HRC	~68HRC						
✓	✓	✓	✓				✓			✓	✓

● Ex Stock / ab Lager ○ On demand / auf Anfrage

Recommended cutting data · Empfohlene Schnittdaten

Type Typ	Grade Sorte	Material Werkstoffe	d ₁ (mm)	z	V _c (m/min)	f _z (mm/z)	a _p (mm)	a _e (mm)	n (min ⁻¹)	V _f (mm/min)
 	KMG303	P Steel Stahl HRC<=32	10	4	100	0.040	10	5	3183	509
			12	4	100	0.050	12	6	2653	531
			16	4	100	0.065	16	8	1989	517
			20	4	100	0.080	20	10	1592	509
		K Cast iron Guss	10	4	80	0.035	10	5	2546	357
			12	4	80	0.045	12	6	2122	382
			16	4	80	0.060	16	8	1592	382
			20	4	80	0.070	20	10	1273	357
		S Ti and Ti alloys Ti-Legierungen	10	4	120	0.045	10	5	3820	688
			12	4	120	0.055	12	6	3183	700
			16	4	120	0.070	16	8	2387	668
			20	4	120	0.090	20	10	1910	668
		S Ti and Ti alloys Ti-Legierungen	10	4	30	0.035	10	5	955	134
			12	4	30	0.045	12	6	796	143
			16	4	30	0.060	16	8	597	143
			20	4	30	0.070	20	10	477	134

- Please start a test cutting with 85% of the V_c or 75% of the f_z, then increase the cutting speed and feed rate.
- Please use high precision and high rigidity clamping system. The oscillation of the tool can not be over 0.01 mm.
- When a_p=1*d₁, f_z = 75% as the data in the table.
- When HRC>=30, reduce the a_p or a_c.
- Recommended operation: climb milling.

- Bitte führen Sie einen Testschnitt mit 85% der V_c und 75% des f_z durch.
- Nach erfolgtem Test können Sie die Schnittgeschwindigkeit bzw. die Vorschubwerte entsprechend erhöhen.
- Bitte verwenden Sie nur Spannmittel mit einer hohen Genauigkeit und einer hohen Spannkraft.
- Überprüfen Sie den Rundlauf der Werkzeuge. Sie sollten darauf achten, dass der Rundlauffehler nicht größer als 0.01 mm ist.
- Bei Fräsoperationen, die mit einer a_p=1*d₁ durchgeführt werden, ist f_z um 25% zu reduzieren.
- Wenn HRC>=30, reduzieren Sie a_p oder a_c.
- Empfohlene Fräsmethode: Gleichlauffräsen.

Milling - Fräsen

Solid Carbide end mills - Vollhartmetallschaftfräser

Recommended cutting data · Empfohlene Schnittdaten

GM-4W side milling

Workpiece material Werkstückmaterial	Cast iron, Nodular cast iron Grauguss GGG		Carbon steel, Alloy steel Kohlenstoffstahl Leg. Stahl ~750N/mm ²		Carbon steel, Alloy steel Kohlenstoffstahl Leg. Stahl ~30HRC		Pre-hardened steel, Quenched and tempered steel Vergüteter Stahl ~40HRC		Stainless steel Rostfreier Stahl	
	Diameter Ø Durchmesser (mm)	Rotating Drehzahl (min ⁻¹)	Feed Vorschub (mm/min)	Rotating Drehzahl (min ⁻¹)	Feed Vorschub (mm/min)	Rotating Drehzahl (min ⁻¹)	Feed Vorschub (mm/min)	Rotating Drehzahl (min ⁻¹)	Feed Vorschub (mm/min)	Rotating Drehzahl (min ⁻¹)
6	6350	760	5300	640	4500	360	3450	280	2650	210
7	5460	760	4550	640	3650	360	3000	280	2250	310
8	4750	760	4000	640	3400	410	2650	310	2000	240
9	4250	760	3540	640	2850	410	2300	310	1750	240
10	3800	760	3200	640	2700	430	2050	330	1600	260
11	3470	760	2900	640	2400	430	1850	330	1450	260
12	3200	770	2250	650	1950	470	1500	360	1150	280
16	2400	770	2000	640	1700	480	1300	360	1000	280
20	1900	760	1600	610	1350	470	1050	350	800	260

Max. cutting depth max Schnitttiefe	

1. Please select high precise machine and tool holder.
2. Please use air blow or cutting liquid with high mist retardant property.
3. Down milling is recommended in side milling.
4. Vibration and unusual noise may be generated if the machine rigidity and workpiece fixture stability is low, please reduce the rotating speed and feed rate like mentioned above.
5. Make overhang as short as possible if no interference.

1. Bitte präzise Maschinen und Werkzeughalter verwenden.
2. Bitte Luftkühlung oder Schneidflüssigkeit benutzen.
3. Empfohlene Fräsmethode: Gleichlaufräsen.
4. Bei Vibrationen oder unüblichen Geräuschen reduzieren Sie die Schnittdaten (wie oben empfohlen) entsprechend.
5. Werkzeugauskragung so kurz wie möglich wählen.

B

Solid Carbide end mills
Vollhartmetallschaftfräser

Recommended cutting data · Empfohlene Schnittdaten

GM-4W slot milling

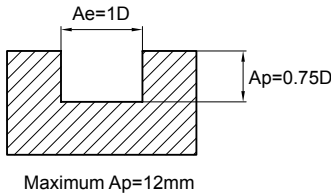
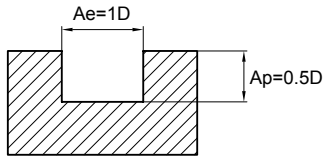
Workpiece material Werkstück-material	Cast iron, Nodular cast iron Grauguss GGG		Carbon steel, Alloy steel Kohlenstoffstahl Leg. Stahl ~750N/mm ²		Carbon steel, Alloy steel Kohlenstoffstahl Leg. Stahl ~30HRC		Pre-hardened steel, Quenched and tempered steel Vergüteter Stahl ~40HRC		Stainless steel Rostfreier Stahl		
Cutting speed Schnittgeschw.	80~120 m/min		70~100m/min		60~90m/min		40~70m/min		30~60m/min		
Diameter Ø Durchmesser (mm)	Rotating Drehzahl (min ⁻¹)	Feed Vorschub (mm/min)	Rotating Drehzahl (min ⁻¹)	Feed Vorschub (mm/min)	Rotating Drehzahl (min ⁻¹)	Feed Vorschub (mm/min)	Rotating Drehzahl (min ⁻¹)	Feed Vorschub (mm/min)	Rotating Drehzahl (min ⁻¹)	Feed Vorschub (mm/min)	
6	5300	640	4500	540	3700	300	2900	230	2400	190	
7	4500	630	3800	540	3200	300	2500	230	2050	190	
8	4000	640	3400	540	2800	340	2200	260	1800	220	
9	3500	630	3000	540	2450	340	1950	260	1600	220	
10	3200	640	2700	540	2250	360	1750	280	1450	230	
11	3000	630	2450	540	2050	360	1600	280	1300	230	
12	2650	640	2250	540	1850	370	1450	290	1200	240	
16	2000	640	1700	540	1400	390	1100	310	900	250	
20	1600	640	1350	510	1100	390	900	300	700	230	
Max. cutting depth max Schnitttiefe	 <p>Maximum Ap=12mm</p>										

1. Please select high precise machine and tool holder.
2. Please use air blow or cutting liquid with high mist retardant property.
3. Vibration and unusual noise may be generated if the machine rigidity and workpiece fixture stability is low, please reduce the rotating speed and feed rate like mentioned above.
4. Make overhang as short as possible if no interference.

1. Bitte präzise Maschine und Werkzeugaufnahmen wählen.
2. Bitte Luftkühlung oder Schneidflüssigkeit benutzen.
3. Bei Vibrationen oder unüblichen Geräuschen reduzieren Sie die Schnittdaten (wie oben empfohlen) entsprechend.
4. Werkzeugauskragung so kurz wie möglich wählen.

NOTES / NOTIZEN:

A series of horizontal dotted lines for taking notes.

B

Solid Carbide end mills
Vollhartmetallschaftfräser

series end mills for machining high-hardness steel

HM

Serie Vollhartmetall Schaftfräser zur Bearbeitung von gehärtetem Stahl

1. Excellent tool design covers large chip pocket, good stability and high machining efficiency.
2. Optimized cutting geometry ensures high edge stability in machining of hard materials. The application area is wider.
3. The outstanding high cutting performance based on the perfect combination of ultrafine grain carbide substrate with high wear resistance and stable cutting edge.
4. The optimized HIPIMS technology is the base for hardmachining with high speed at high temperature.

1. Exzellentes Werkzeug Design, mit großem Spanraum für kontrollierte Spanabfuhr, hervorragende Stabilität und höchste Bearbeitungswirtschaftlichkeit.
2. Optimierter Schneidengeometrie gewährleistet eine hohe Kantenstabilität bei der Bearbeitung harter Werkstoffe. Anwendungsbereich wird dadurch deutlich erweitert.
3. Das ultrafeine Hartmetall Substrat, und die optimierte Beschichtung ist speziell für die Bearbeitung von gehärtetem Stahl entwickelt.
4. Die HIPIMS Technologie ist perfekt geeignet für die Hartbearbeitung bei hohen Temperaturen.

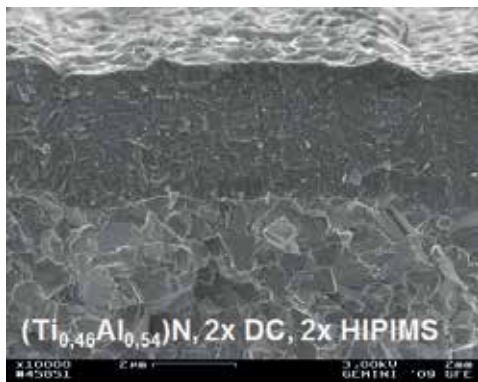

Hard / Härte: 34 GPa (+/- 4)
Young's modulus: 377 GPa (+/- 14)

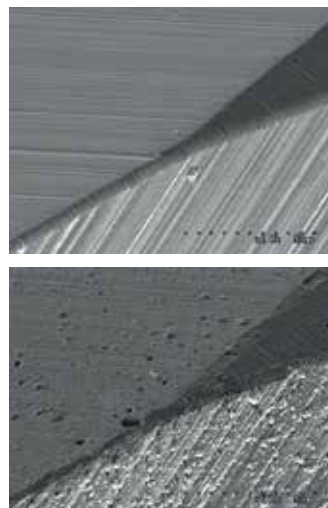

Arc Coating (competitor)
Arc-Beschichtung (Wettbewerb)

HiPIMS HSN²

HM series end mills for machining high hardness steel HM Serie Eckfräser für die Bearbeitung von gehärtetem Stahl

Tool type · Werkzeugtyp : HM-4E-D6.0

Size / Größe : Ø 6mm
 Workpiece material
 Werkstückstoff : SKD11(62HRC)
 Rotating speed / Drehzahl : 10000 r/min(188m/min)
 Feed / Vorschub : 2000 mm/min (0.2mm/r)
 Axial cutting depth /
 Axiale Zustellung : $A_p=9\text{mm}$
 Radial cutting depth
 Radiale Zustellung: $A_e=0.1\text{mm}$
 Cutting style / Bearbeitungsart : cycloid machining / Zykloid Bearbeitung
 Cooling system / Kuhlssystem : air blow
 Machine / Maschine: MIKRON UCP 1000

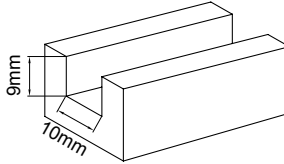

■ Tool wear · Werkzeugverschleiß

Cycloid machining of end mill
Zyklische Bearbeitung

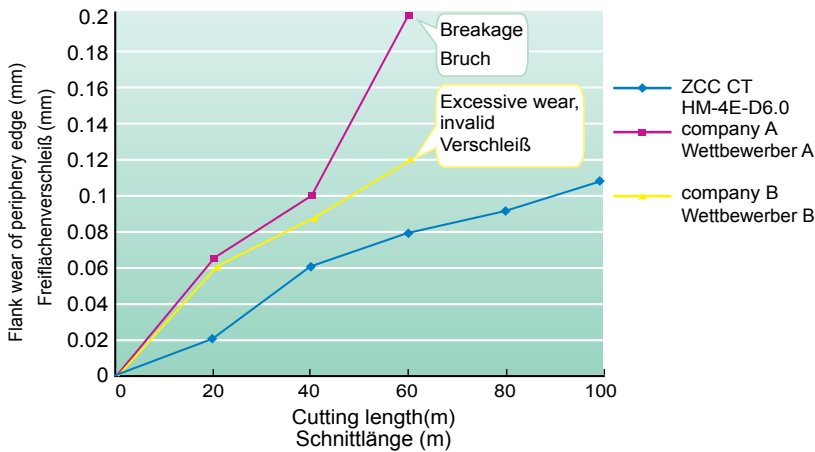

HM-4E-D6.0

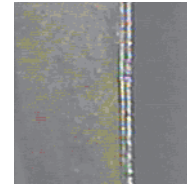

Cutting length: 60m
Schnittlänge: 60m



Cutting length: 100m
Schnittlänge: 100m

Similar product of company A

Ähnliches Produkt von Wettbewerber A

Similar product of company B

Ähnliches Produkt von Wettbewerber B



Cutting length: 60m
Schnittlänge: 60m



Cutting length: 60m
Schnittlänge: 60m

Tool type / Werkzeug : HM-2B-R3.0

Size / Größe : Ø 3.0mm
 Workpiece material
 Werkstückstoff : SKD61(52HRC)
 Rotating speed / Drehzahl : 6400r/min (120m/min)
 Feed / Vorschub : 1280mm/min (0.2mm/r)
 Axial cutting depth /
 Axiale Zustellung : $A_p=0.12\text{mm}$
 Radial cutting depth /
 Radiale Zustellung: $A_e=0.24\text{mm}$
 Cutting style / Bearbeitungsart : Pocket finishing / Tasche Schlichten
 Cooling system: air blow
 Machine / Maschine: MIKRON UCP 1000

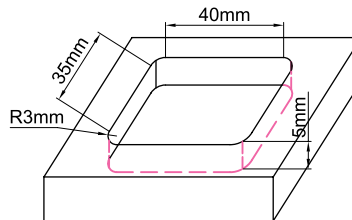

■ Wear after machining 5 cavities Verschleiß nach 5 Werkstücken

Cavity machining with ball nose end mills
Ausammern mit Kugelkopffräsern

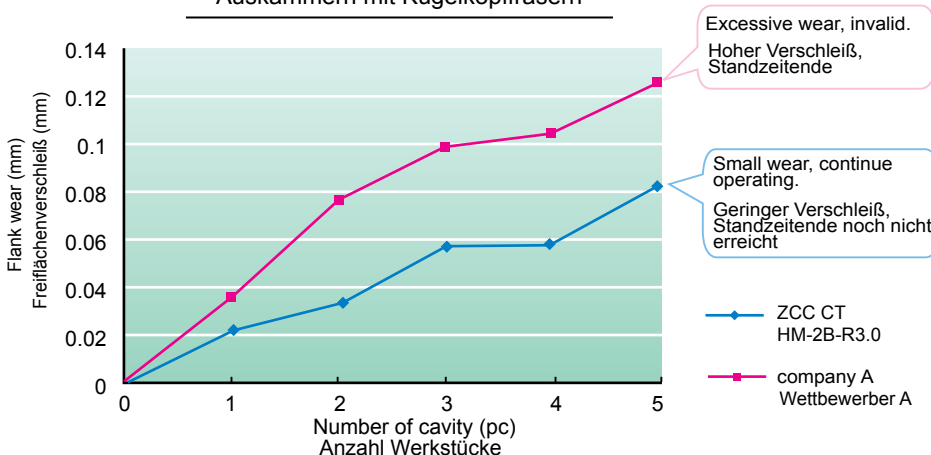

HM-2B-R3.0



Similar product of company A

Ähnliches Produkt von Wettbewerber A

HM-2E

2-flute end mills with straight shank
2-Schneiden Eckfräser mit Zylinderschaft

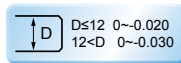
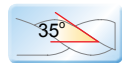
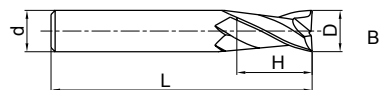
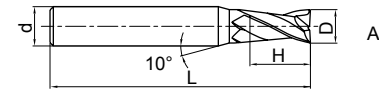

Type Typ	Dimension (mm) Abmessungen				Teeth Zähne Z	Geometry Ausführung	Grade Sorte KMG 555
	D	d	H	L			
HM-2E-D1.0S	1.0	4	3	50	2	A	●
HM-2E-D1.5S	1.5	4	4	50	2	A	●
HM-2E-D2.0S	2.0	4	6	50	2	A	●
HM-2E-D2.5S	2.5	4	8	50	2	A	●
HM-2E-D3.0S	3.0	4	8	50	2	A	●
HM-2E-D4.0S	4.0	4	11	50	2	B	●
HM-2E-D1.0	1.0	6	3	50	2	A	●
HM-2E-D1.5	1.5	6	4	50	2	A	●
HM-2E-D2.0	2.0	6	6	50	2	A	●
HM-2E-D2.5	2.5	6	8	50	2	A	●
HM-2E-D3.0	3.0	6	8	50	2	A	●
HM-2E-D3.5	3.5	6	10	50	2	A	●
HM-2E-D4.0	4.0	6	11	50	2	A	●
HM-2E-D4.5	4.5	6	11	50	2	A	●
HM-2E-D5.0	5.0	6	13	50	2	A	●
HM-2E-D5.5	5.5	6	16	50	2	A	●
HM-2E-D6.0	6.0	6	16	50	2	B	●
HM-2E-D7.0	7.0	8	20	60	2	A	●
HM-2E-D8.0	8.0	8	20	60	2	B	●
HM-2E-D9.0	9.0	10	22	75	2	A	●
HM-2E-D10.0	10.0	10	25	75	2	B	●
HM-2E-D11.0	11.0	12	26	75	2	A	○
HM-2E-D12.0	12.0	12	30	75	2	B	●
HM-2E-D14.0	14.0	14	32	100	2	B	●
HM-2E-D16.0	16.0	16	45	100	2	B	●
HM-2E-D18.0	18.0	18	45	100	2	B	○
HM-2E-D20.0	20.0	20	45	100	2	B	●

Material Overview · Material Übersicht

✓ = Very suitable · Sehr empfohlen
✓ = Suitable · Empfohlen

KMG555

Workpiece material Werkstückstoff											
Carbon steel Kohlenstoff Stahl	Alloy steel Legierter Stahl	Quenched and tempered steel · Vergüteter Stahl		Hardened steel · Gehärteter Stahl		Stainless steel · Rostfreier Stahl	Cast iron, Nodular cast iron Grauguss GGG	Copper alloy Kupfer Leg	Aluminum alloy Alu Leg	Titanium alloy Titan Leg	Heat resist alloy warmfeste Leg
		~40HRC	~50HRC	~60HRC	~68HRC						
			✓	✓	✓		✓				

Code key B252,B254
ISO Kennzeichen

Cutting data B404-B408
Schnittdaten

Graphics identification & application B253,B255
Graphische Werkzeug- & Anwendungsbeschr.

Order form for non-standard products B534-B535
Bestellformular für Sonderwerkzeuge

Milling · Fräsen

Solid Carbide end mills · Vollhartmetallschaftfräser

HM-2EFP

2-flute flute end mills with straight shank and short cutting edge and long neck
2-Schneiden Eckfräser mit kurzer Schneide und Zylinderschaft

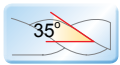
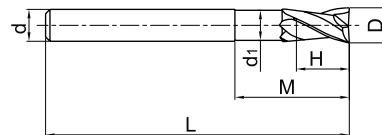

Type Typ	Dimension (mm) Abmessungen						Teeth Zähne Z	Grade Sorte KMG 555
	D	d	H	M	d ₁	L		
HM-2EFP-D6.0	6.0	6	9	30	5.8	75	2	●
HM-2EFP-D8.0	8.0	8	12	40	7.8	100	2	●
HM-2EFP-D10.0	10.0	10	15	50	9.6	100	2	●
HM-2EFP-D12.0	12.0	12	18	50	11.5	100	2	●
HM-2EFP-D16.0	16.0	16	24	50	15.5	150	2	●
HM-2EFP-D20.0	20.0	20	30	60	19.5	150	2	●

B

Solid Carbide end mills
Vollhartmetallschaftfräser

Material Overview · Material Übersicht

✓ = Very suitable · Sehr empfohlen
✓ = Suitable · Empfohlen

KMG555

Workpiece material Werkstückstoff											
Carbon steel Kohlenstoff Stahl	Alloy steel Legierter Stahl	Quenched and tempered steel · Vergüteter Stahl		Hardened steel · Gehärteter Stahl		Stainless steel · Rostfreier Stahl	Cast iron, Nodular cast iron Grauguss GGG	Copper alloy Kupfer Leg	Aluminum alloy Alu Leg	Titanium alloy Titan Leg	Heat resist alloy warmfeste Leg
		~40HRC	~50HRC	~60HRC	~68HRC						
			✓	✓	✓		✓				

● Ex Stock / ab Lager ○ On demand / auf Anfrage

HM-2EP series for machining high hardness steel · **HM-2EP** Serie für die Hartbearbeitung

2-flute slot end mills with short cutting edge and long neck
2-Schneiden Nutenfräser mit kurzer Schneide und Zylinderschaft

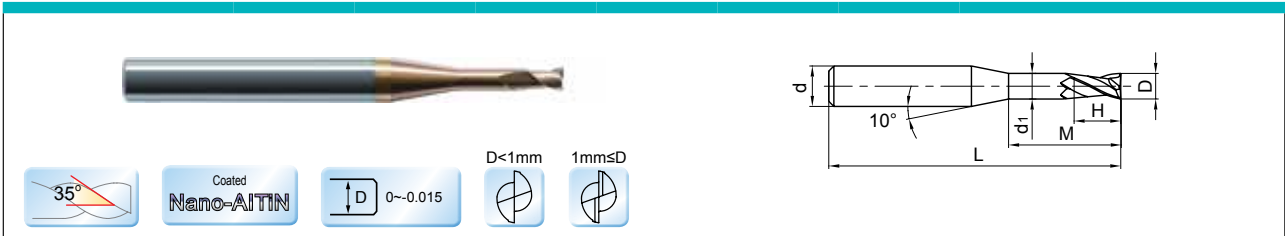

Type Typ	Dimension(mm) Abmessungen						Teeth Zähne Z	Grade Sorte KMG 555
	D	d	H	M	d ₁	L		
HM-2EP-D0.5-M04	0.5	4.0	0.7	4.0	0.45	50	2	●
HM-2EP-D0.5-M06	0.5	4.0	0.7	6.0	0.45	50	2	●
HM-2EP-D0.5-M08	0.5	4.0	0.7	8.0	0.45	50	2	●
HM-2EP-D0.8-M04	0.8	4.0	1.2	4.0	0.75	50	2	●
HM-2EP-D0.8-M06	0.8	4.0	1.2	6.0	0.75	50	2	●
HM-2EP-D0.8-M08	0.8	4.0	1.2	8.0	0.75	50	2	●
HM-2EP-D0.8-M10	0.8	4.0	1.2	10.0	0.75	50	2	●
HM-2EP-D1.0-M04	1.0	4.0	1.5	4.0	0.95	50	2	●
HM-2EP-D1.0-M06	1.0	4.0	1.5	6.0	0.95	50	2	●
HM-2EP-D1.0-M08	1.0	4.0	1.5	8.0	0.95	50	2	●
HM-2EP-D1.0-M10	1.0	4.0	1.5	10.0	0.95	50	2	●
HM-2EP-D1.0-M12	1.0	4.0	1.5	12.0	0.95	50	2	●
HM-2EP-D1.0-M14	1.0	4.0	1.5	14.0	0.95	50	2	●
HM-2EP-D1.2-M06	1.2	4.0	1.8	6.0	1.15	50	2	●
HM-2EP-D1.2-M08	1.2	4.0	1.8	8.0	1.15	50	2	●
HM-2EP-D1.2-M10	1.2	4.0	1.8	10.0	1.15	50	2	●
HM-2EP-D1.2-M12	1.2	4.0	1.8	12.0	1.15	50	2	●
HM-2EP-D1.5-M06	1.5	4.0	2.3	6.0	1.45	50	2	●
HM-2EP-D1.5-M08	1.5	4.0	2.3	8.0	1.45	50	2	●
HM-2EP-D1.5-M10	1.5	4.0	2.3	10.0	1.45	50	2	●
HM-2EP-D1.5-M12	1.5	4.0	2.3	12.0	1.45	50	2	●
HM-2EP-D1.5-M14	1.5	4.0	2.3	14.0	1.45	50	2	●
HM-2EP-D2.0-M06	2.0	4.0	3.0	6.0	1.95	50	2	●
HM-2EP-D2.0-M08	2.0	4.0	3.0	8.0	1.95	50	2	●
HM-2EP-D2.0-M10	2.0	4.0	3.0	10.0	1.95	50	2	●
HM-2EP-D2.0-M12	2.0	4.0	3.0	12.0	1.95	50	2	●
HM-2EP-D2.0-M14	2.0	4.0	3.0	14.0	1.95	50	2	●
HM-2EP-D2.0-M16	2.0	4.0	3.0	16.0	1.95	50	2	●

Material Overview · Material Übersicht

✓ = Very suitable · Sehr empfohlen
 ✓ = Suitable · Empfohlen

KMG555

Workpiece material Werkstückstoff											
Carbon steel Kohlenstoff Stahl	Alloy steel Legierter Stahl	Quenched and tempered steel · Vergüteter Stahl		Hardened steel · Gehärteter Stahl		Stainless steel · Rostfreier Stahl	Cast iron, Nodular cast iron Grauguss GGG	Copper alloy Kupfer Leg	Aluminum alloy Alu Leg	Titanium alloy Titan Leg	Heat resist alloy warmfeste Leg
		~40HRC	~50HRC	~60HRC	~68HRC						
			✓	✓	✓		✓				

Code key **B252,B254**
ISO Kennzeichen

Cutting data **B404-B408**
Schnittdaten

Graphics identification & application **B253,B255**
Graphische Werkzeug- & Anwendungsbeschr.

Order form for non-standard products **B534-B535**
Bestellformular für Sonderwerkzeuge

Milling · Fräsen

Solid Carbide end mills · Vollhartmetallschaftfräser

HM-2EP series for machining high hardness steel · **HM-2EP** Serie für die Hartbearbeitung

2-flute slot end mills with short cutting edge and long neck
2-Schneiden Nutenfräser mit kurzer Schneide und Zylinderschaft

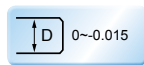
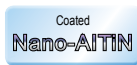
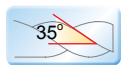
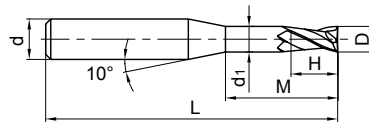

Type Typ	Dimension(mm) Abmessungen						Teeth Zähne Z	Grade Sorte KMG 555
	D	d	H	M	d ₁	L		
HM-2EP-D2.5-M08	2.5	4.0	3.7	8.0	2.4	50	2	●
HM-2EP-D2.5-M10	2.5	4.0	3.7	10.0	2.4	50	2	●
HM-2EP-D2.5-M12	2.5	4.0	3.7	12.0	2.4	50	2	●
HM-2EP-D2.5-M14	2.5	4.0	3.7	14.0	2.4	50	2	●
HM-2EP-D2.5-M16	2.5	4.0	3.7	16.0	2.4	60	2	●
HM-2EP-D2.5-M18	2.5	4.0	3.7	18.0	2.4	60	2	●
HM-2EP-D2.5-M20	2.5	4.0	3.7	20.0	2.4	60	2	●
HM-2EP-D3.0-M06	3.0	6.0	4.5	6.0	2.85	50	2	●
HM-2EP-D3.0-M08	3.0	6.0	4.5	8.0	2.85	50	2	●
HM-2EP-D3.0-M10	3.0	6.0	4.5	10.0	2.85	50	2	●
HM-2EP-D3.0-M12	3.0	6.0	4.5	12.0	2.85	50	2	●
HM-2EP-D3.0-M14	3.0	6.0	4.5	14.0	2.85	60	2	●
HM-2EP-D3.0-M16	3.0	6.0	4.5	16.0	2.85	60	2	●
HM-2EP-D3.0-M18	3.0	6.0	4.5	18.0	2.85	60	2	●
HM-2EP-D3.0-M20	3.0	6.0	4.5	20.0	2.85	60	2	●
HM-2EP-D4.0-M12	4.0	6.0	6.0	12.0	3.85	60	2	●
HM-2EP-D4.0-M16	4.0	6.0	6.0	16.0	3.85	60	2	●
HM-2EP-D4.0-M20	4.0	6.0	6.0	20.0	3.85	60	2	●
HM-2EP-D4.0-M25	4.0	6.0	6.0	25.0	3.85	60	2	●
HM-2EP-D5.0-M16	5.0	6.0	7.5	16.0	4.85	60	2	●
HM-2EP-D5.0-M25	5.0	6.0	7.5	25.0	4.85	70	2	●

B

Solid Carbide end mills
Vollhartmetallschaftfräser

Material Overview · Material Übersicht

✓ = Very suitable · Sehr empfohlen
✓ = Suitable · Empfohlen

KMG555

Workpiece material Werkstückstoff											
Carbon steel Kohlenstoff Stahl	Alloy steel Legierter Stahl	Quenched and tempered steel · Vergüteter Stahl		Hardened steel · Gehärteter Stahl		Stainless steel · Rostfreier Stahl	Cast iron, Nodular cast iron Grauguss GGG	Copper alloy Kupfer Leg	Aluminum alloy Alu Leg	Titanium alloy Titan Leg	Heat resist alloy warmfeste Leg
		~40HRC	~50HRC	~60HRC	~68HRC						
			✓	✓	✓		✓				

● Ex Stock / ab Lager ○ On demand / auf Anfrage

HM-2ES series machining high hardness steel · HM-2ES Serie für die Hartbearbeitung

2-flute tiny diameter end mills with straight shank
2-Schneiden Mirco-Fräser mit Zylinderschaft

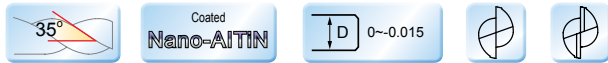
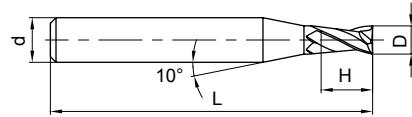
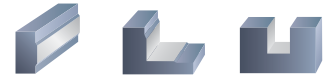

Type Typ	Dimension(mm) Abmessungen				Teeth Zähne Z	Grade Sorte KMG 555
	D	d	H	L		
HM-2ES-D0.3	0.3	4.0	0.6	50	2	●
HM-2ES-D0.4	0.4	4.0	0.8	50	2	●
HM-2ES-D0.5	0.5	4.0	1.0	50	2	●
HM-2ES-D0.6	0.6	4.0	1.2	50	2	●
HM-2ES-D0.7	0.7	4.0	1.4	50	2	●
HM-2ES-D0.8	0.8	4.0	1.6	50	2	●
HM-2ES-D0.9	0.9	4.0	1.8	50	2	●
HM-2ES-D1.0	1.0	4.0	2.0	50	2	●
HM-2ES-D1.1	1.1	4.0	2.0	50	2	●
HM-2ES-D1.2	1.2	4.0	2.5	50	2	●
HM-2ES-D1.3	1.3	4.0	2.5	50	2	●
HM-2ES-D1.4	1.4	4.0	3.0	50	2	●
HM-2ES-D1.5	1.5	4.0	3.0	50	2	●
HM-2ES-D1.6	1.6	4.0	3.5	50	2	●
HM-2ES-D1.7	1.7	4.0	3.5	50	2	●
HM-2ES-D1.8	1.8	4.0	4.0	50	2	●
HM-2ES-D1.9	1.9	4.0	4.0	50	2	●
HM-2ES-D2.0	2.0	4.0	4.0	50	2	●
HM-2ES-D2.1	2.1	4.0	4.0	50	2	●
HM-2ES-D2.2	2.2	4.0	4.5	50	2	●
HM-2ES-D2.3	2.3	4.0	4.5	50	2	●
HM-2ES-D2.4	2.4	4.0	5.0	50	2	●
HM-2ES-D2.5	2.5	4.0	5.0	50	2	●
HM-2ES-D2.6	2.6	4.0	5.0	50	2	●
HM-2ES-D2.7	2.7	4.0	5.5	50	2	●
HM-2ES-D2.8	2.8	4.0	5.5	50	2	●
HM-2ES-D2.9	2.9	4.0	6.0	50	2	●
HM-2ES-D3.0	3.0	4.0	6.0	50	2	●

Material Overview · Material Übersicht

✓ = Very suitable · Sehr empfohlen
✓ = Suitable · Empfohlen

Workpiece material Werkstückstoff											
Carbon steel Kohlenstoff Stahl	Alloy steel Legierter Stahl	Quenched and tempered steel · Vergüteter Stahl		Hardened steel · Gehärteter Stahl		Stainless steel · Rostfreier Stahl	Cast iron, Nodular cast iron Grauguss GGG	Copper alloy Kupfer Leg	Aluminum alloy Alu Leg	Titanium alloy Titan Leg	Heat resist alloy warmfeste Leg
		~40HRC	~50HRC	~60HRC	~68HRC						
			✓	✓	✓		✓				

KMG555

Code key B252,B254
ISO Kennzeichen

Cutting data B404-B408
Schnittdaten

Graphics identification & application B253,B255
Graphische Werkzeug- & Anwendungsbeschr.

Order form for non-standard products B534-B535
Bestellformular für Sonderwerkzeuge

Milling - Fräsen

Solid Carbide end mills - Vollhartmetallschaftfräser

Recommended cutting data - Empfohlene Schnittdaten

HM-2E

Workpiece material Werkstück-material	Pre-hardened steel, Hardened steel Vergüteter Stahl, Gehärteter Stahl 40~50HRC		Hardened steel Gehärteter Stahl 50~60HRC		Hardened steel Gehärteter Stahl 60~68HRC	
	Diameter Ø Durchmesser (mm)	Rotating Drehzahl (min ⁻¹)	Feed Vorschub (mm/min)	Rotating Drehzahl (min ⁻¹)	Feed Vorschub (mm/min)	Rotating Drehzahl (min ⁻¹)
1	40000	160	40000	160	32000	130
2	40000	400	24000	240	16000	160
3	32000	510	16000	255	11000	175
4	24000	625	12000	310	8000	210
5	19000	685	9500	340	6400	230
6	16000	770	8000	385	5300	255
8	12000	770	6000	385	4000	255
10	9600	770	4800	385	3200	255
12	8000	800	4000	400	2700	270
14	6800	680	3400	340	2300	230
16	6000	600	3000	300	2000	200
18	5300	530	2700	270	1800	180
20	4800	480	2400	240	1600	160
Max. cutting depth max Schnitttiefe	<p>Ae=0.05D Ap=1.5D Maximum Ae=1.0mm</p>		<p>Ae=0.03D Ap=1D Maximum Ae=0.5mm</p>		<p>Ae=0.02D Ap=1D Maximum Ae=0.3mm</p>	

1. Please select machine and holder with high precision and rigidity.
2. Vibration and unusual noise may be generated if the machine rigidity and workpiece fixture stability is low, please reduce the rotating speed and feed rate like mentioned above.
3. Please use air blow or MQL (minimum oil mist cooling).
4. Down milling is recommended in side milling.
5. Make overhang as short as possible if no interference.

1. Bitte präzise Maschinen und Werkzeughalter verwenden.
2. Bei Vibrationen oder unüblichen Geräuschen reduzieren Sie die Schnittdaten (wie oben empfohlen) entsprechend.
3. Bitte Luftkühlung oder MQL (Minimalmengen) benutzen.
4. Empfohlene Fräsmethode: Gleichlaufräsen.
5. Werkzeugauskrantung so kurz wie möglich wählen.

Recommended cutting data · Empfohlene Schnittdaten

HM-2EFP

Workpiece material Werkstück-material	Pre-hardened steel, Hardened steel Vergüteter Stahl, Gehärteter Stahl 40~50HRC		Hardened steel Gehärteter Stahl 50~60HRC		Hardened steel Gehärteter Stahl 60~68HRC	
	Diameter Ø Durchmesser (mm)	Rotating Drehzahl (min ⁻¹)	Feed Vorschub (mm/min)	Rotating Drehzahl (min ⁻¹)	Feed Vorschub (mm/min)	Rotating Drehzahl (min ⁻¹)
6	16000	1155	8000	460	5300	305
8	12000	1155	6000	460	4000	305
10	9600	1155	4800	460	3200	305
12	8000	1200	4000	480	2700	325
16	6000	900	3000	360	2000	240
20	4800	720	2400	285	1600	195
Max. cutting depth max Schnitttiefe						

1. Please select machine and holder with high precision and rigidity.
2. Vibration and unusual noise may be generated if the machine rigidity and workpiece fixture stability is low, please reduce the rotating speed and feed rate like mentioned above.
3. Please use air blow or MQL (minimum oil mist cooling).
4. Down milling is recommended in side milling.
5. Make overhang as short as possible if no interference.

1. Bitte präzise Maschinen und Werkzeughalter verwenden.
2. Bei Vibrationen oder unüblichen Geräuschen reduzieren Sie die Schnittdaten (wie oben empfohlen) entsprechend.
3. Bitte Luftkühlung oder MQL (Minimalmengen) benutzen.
4. Empfohlene Fräsmethode: Gleichlaufräsen.
5. Werkzeugauskragung so kurz wie möglich wählen.

Milling · Fräsen

Solid Carbide end mills · Vollhartmetallschaftfräser

Recommended cutting data · Empfohlene Schnittdaten

HM-2EP

Workpiece material Werkstückstoff		Pre-hardened steel, Hardened steel Vergüteter Stahl, Gehärteter Stahl 40~50HRC			Hardened steel Gehärteter Stahl 50~60HRC		
Diameter Ø Durchmesser (mm)	Effective length Effektive Länge (mm)	Rotating Drehzahl (min ⁻¹)	Feed Vorschub (mm/min)	Ap (mm)	Rotating Drehzahl (min ⁻¹)	Feed Vorschub (mm/min)	Ap (mm)
0.5	4	21000	100	0.009	17000	50	0.009
	6	20000	75	0.006	1500	35	0.007
	8	20000	50	0.002	1500	20	0.003
0.8	4	20000	200	0.022	14000	100	0.011
	6	18000	150	0.014	14000	75	0.009
	8	18000	100	0.01	14000	50	0.006
	10	18000	75	0.007	14000	30	0.004
1.0	4	17000	400	0.035	12000	100	0.016
	6	17000	400	0.03	12000	100	0.014
	8	15000	300	0.02	10000	75	0.01
	10	15000	250	0.015	10000	50	0.008
	12	12000	150	0.01	10000	50	0.006
1.2	6	14000	400	0.03	10000	100	0.017
	8	12000	300	0.03	10000	100	0.014
	10	12000	300	0.02	10000	75	0.01
	12	10000	200	0.01	10000	50	0.00
	14	10000	250	0.02	7000	75	0.005
1.5	6	12000	400	0.06	8000	200	0.028
	8	10000	300	0.04	7000	150	0.021
	10	10000	300	0.03	7000	150	0.017
	12	10000	300	0.025	7000	100	0.01
	14	10000	250	0.02	7000	75	0.005
2.0	6	9000	400	0.13	6000	300	0.07
	8	9000	400	0.11	6000	300	0.06
	10	7000	300	0.10	6000	200	0.05
	12	7000	300	0.06	6000	200	0.03
	14	7000	250	0.04	6000	150	0.015
	16	7000	200	0.02	6000	100	0.008

Max. cutting depth
max Schnitttiefe

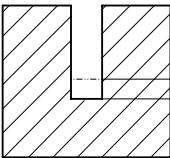

Ap (per cut/ pro Schnitt)

B

Solid Carbide end mills
Vollhartmetallschaftfräser

Recommended cutting data · Empfohlene Schnittdaten

HM-2EP

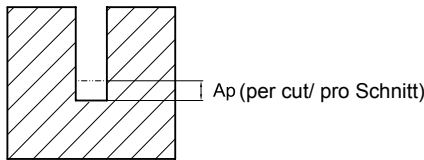
Workpiece material Werkstückstoff		Pre-hardened steel, Hardened steel Vergüteter Stahl, Gehärteter Stahl 40~50HRC			Hardened steel Gehärteter Stahl 50~60HRC		
Diameter Ø Durchmesser (mm)	Effective length Effektive Länge (mm)	Rotating Drehzahl (min ⁻¹)	Feed Vorschub (mm/min)	Ap (mm)	Rotating Drehzahl (min ⁻¹)	Feed Vorschub (mm/min)	Ap (mm)
2.5	8	8000	400	0.16	5000	300	0.08
	10	8000	400	0.14	5000	300	0.07
	12	8000	400	0.09	5000	300	0.05
	14	6000	300	0.07	5000	200	0.03
	16	6000	300	0.05	5000	200	0.025
	18	6000	300	0.04	5000	150	0.02
	20	6000	300	0.02	5000	100	0.01
3.0	6	7000	400	0.18	5000	300	0.10
	8	7000	400	0.15	5000	300	0.08
	10	7000	400	0.12	5000	300	0.06
	12	7000	400	0.10	5000	300	0.05
	14	6000	300	0.08	5000	200	0.04
	16	6000	300	0.06	5000	200	0.03
	18	6000	300	0.05	5000	200	0.025
	20	6000	250	0.04	5000	150	0.01
4.0	12	4500	400	0.16	4000	300	0.08
	16	4500	400	0.14	4000	300	0.06
	20	4500	300	0.10	4000	300	0.04
	25	4500	300	0.08	4000	300	0.03
5.0	16	4000	400	0.19	3000	300	0.09
	25	4000	400	0.15	3000	300	0.06
Max. cutting depth max Schnitttiefe							

1. Please select high precise machine and tool holder.
2. Please use air blow or cutting liquid with high mist retardant property.
3. Vibration and unusual noise may be generated if the machine rigidity and workpiece fixture stability is low, please reduce the rotating speed and feed rate like mentioned above.
4. Make overhang as short as possible if no interference.

1. Bitte präzise Maschine und Werkzeugaufnahmen wählen.
2. Bitte Luftkühlung oder Schneidflüssigkeit benutzen.
3. Bei Vibrationen oder unüblichen Geräuschen reduzieren Sie die Schnittdaten entsprechend.
4. Werkzeugauskrantung so kurz wie möglich wählen.

Milling · Fräsen

Solid Carbide end mills · Vollhartmetallschaftfräser

Recommended cutting data · Empfohlene Schnittdaten

HM-2ES

Workpiece material Werkstückmaterial	Pre-hardened steel, Hardened steel Vergüteter Stahl, Gehärteter Stahl 40~50HRC		Hardened steel Gehärteter Stahl 50~60HRC																	
Diameter Ø Durchmesser (mm)	Rotating Drehzahl (min ⁻¹)	Feed Vorschub (mm/min)	Rotating Drehzahl (min ⁻¹)	Feed Vorschub (mm/min)																
0.3	32000	150	25000	120																
0.4	32000	200	25000	160																
0.5	21000	400	17000	300																
0.6	21000	480	17000	380																
0.7	20000	520	14000	360																
0.8	20000	560	14000	400																
0.9	17000	560	12000	400																
1.0	17000	640	12000	450																
1.5	12000	800	8000	530																
2.0	9000	800	6000	500																
2.5	8000	720	5000	420																
3.0	7000	640	5000	450																
Max. cutting depth max Schnitttiefe	<table border="1"> <thead> <tr><th colspan="2">Milling slot · Nutenfräsen</th></tr> <tr><th>Ø</th><th>Ap</th></tr> </thead> <tbody> <tr><td>D < Ø1</td><td>0.02D</td></tr> <tr><td>Ø1 ≤ D ≤ Ø3</td><td>0.05D</td></tr> </tbody> </table>		Milling slot · Nutenfräsen		Ø	Ap	D < Ø1	0.02D	Ø1 ≤ D ≤ Ø3	0.05D	<table border="1"> <thead> <tr><th colspan="2">Milling slot · Nutenfräsen</th></tr> <tr><th>Ø</th><th>Ap</th></tr> </thead> <tbody> <tr><td>D < Ø1</td><td>0.01D</td></tr> <tr><td>Ø1 ≤ D ≤ Ø3</td><td>0.02D</td></tr> </tbody> </table>		Milling slot · Nutenfräsen		Ø	Ap	D < Ø1	0.01D	Ø1 ≤ D ≤ Ø3	0.02D
	Milling slot · Nutenfräsen																			
Ø	Ap																			
D < Ø1	0.02D																			
Ø1 ≤ D ≤ Ø3	0.05D																			
Milling slot · Nutenfräsen																				
Ø	Ap																			
D < Ø1	0.01D																			
Ø1 ≤ D ≤ Ø3	0.02D																			

1. Please select high precise machine and tool holder.
2. Please use air blow or cutting liquid with high mist retardant property.
3. Make overhang as short as possible if no interference.
4. Reduce feed correspondingly when rotating speed is low.

1. Bitte präzise Maschine und Werkzeugaufnahmen wählen
2. Bitte Luftkühlung oder MQL (Minimalmenge) benutzen.
3. Empfohlene Fräsmethode: Gleichlaufräsen.
4. Bitte Vorschub entsprechend reduzieren, wenn die Drehzahlen niedrig sind.

● Ex Stock / ab Lager ○ On demand / auf Anfrage

HM-4E series for machining high hardness steel · **HM-4E** Serie für die Hartbearbeitung

4-flute end mills with straight shank
4-Schneiden Schaftfräser mit Zylinderschaft

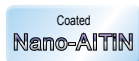
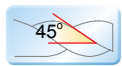
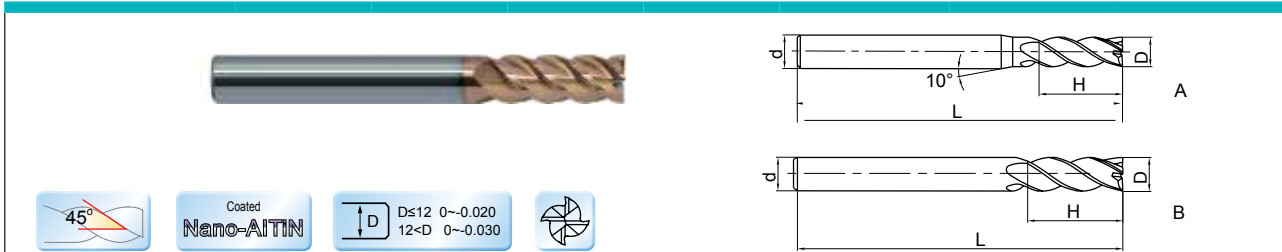
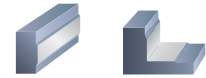

Type Typ	Dimension(mm) Abmessungen				Teeth Zähne Z	Geometry Ausführung	Grade Sorte KMG 555
	D	d	H	L			
HM-4E-D1.0S	1.0	4	3	50	4	A	●
HM-4E-D1.5S	1.5	4	4	50	4	A	●
HM-4E-D2.0S	2.0	4	6	50	4	A	●
HM-4E-D2.5S	2.5	4	8	50	4	A	●
HM-4E-D3.0S	3.0	4	8	50	4	A	●
HM-4E-D4.0S	4.0	4	11	50	4	B	●
HM-4E-D1.0	1.0	6	3	50	4	A	●
HM-4E-D1.5	1.5	6	4	50	4	A	●
HM-4E-D2.0	2.0	6	6	50	4	A	●
HM-4E-D2.5	2.5	6	8	50	4	A	●
HM-4E-D3.0	3.0	6	8	50	4	A	●
HM-4E-D3.5	3.5	6	10	50	4	A	●
HM-4E-D4.0	4.0	6	11	50	4	A	●
HM-4E-D4.5	4.5	6	11	50	4	A	●
HM-4E-D5.0	5.0	6	13	50	4	A	●
HM-4E-D5.5	5.5	6	16	50	4	A	●
HM-4E-D6.0	6.0	6	16	50	4	B	●
HM-4E-D7.0	7.0	8	20	60	4	A	●
HM-4E-D8.0	8.0	8	20	60	4	B	●
HM-4E-D9.0	9.0	10	22	75	4	A	●
HM-4E-D10.0	10.0	10	25	75	4	B	●
HM-4E-D11.0	11.0	12	26	75	4	A	●
HM-4E-D12.0	12.0	12	30	75	4	B	●
HM-4E-D14.0	14.0	14	32	75	4	B	●
HM-4E-D16.0	16.0	16	45	100	4	B	●
HM-4E-D18.0	18.0	18	45	100	4	B	●
HM-4E-D20.0	20.0	20	45	100	4	B	●

Material Overview · Material Übersicht

✓ = Very suitable · Sehr empfohlen
 ✓ = Suitable · Empfohlen

KMG555

Workpiece material Werkstückstoff											
Carbon steel Kohlenstoff Stahl	Alloy steel Legierter Stahl	Quenched and tempered steel · Vergüteter Stahl		Hardened steel · Gehärteter Stahl		Stainless steel · Rostfreier Stahl	Cast iron, Nodular cast iron Grauguss GGG	Copper alloy Kupfer Leg	Aluminum alloy Alu Leg	Titanium alloy Titan Leg	Heat resist alloy warmfeste Leg
		~40HRC	~50HRC	~60HRC	~68HRC						
			✓	✓	✓		✓				

Code key **B252,B254**
ISO Kennzeichen

Cutting data **B412-B413**
Schnittdaten

Graphics identification & application **B253,B255**
Graphische Werkzeug- & Anwendungsbeschr.

Order form for non-standard products **B534-B535**
Bestellformular für Sonderwerkzeuge

Milling · Fräsen

Solid Carbide end mills · Vollhartmetallschaftfräser

HM-4EL series for machining high hardness steel · HM-4EL Serie für die Hartbearbeitung

4-flute end mills with straight shank and long cutting edges
4-Schneiden Schafffräser mit Zylinderschaft und langer Schneide

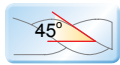
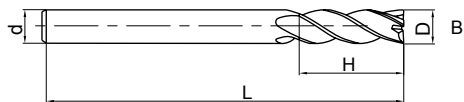
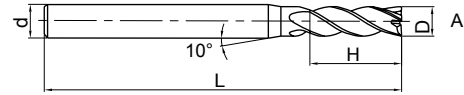
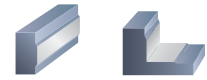

Type Typ	Dimension(mm) Abmessungen				Teeth Zähne Z	Geometry Ausführung	Grade Sorte KMG 555
	D	d	H	L			
HM-4EL-D3.0	3.0	6	12	75	4	A	●
HM-4EL-D4.0	4.0	6	15	75	4	A	●
HM-4EL-D5.0	5.0	6	20	75	4	A	●
HM-4EL-D6.0	6.0	6	20	75	4	B	●
HM-4EL-D8.0	8.0	8	25	100	4	B	●
HM-4EL-D10.0	10.0	10	30	100	4	B	●
HM-4EL-D12.0	12.0	12	35	100	4	B	●
HM-4EL-D14.0	14.0	14	40	100	4	B	●
HM-4EL-D16.0	16.0	16	50	150	4	B	●
HM-4EL-D20.0	20.0	20	55	150	4	B	●

Material Overview · Material Übersicht

✓ = Very suitable · Sehr empfohlen
✓ = Suitable · Empfohlen

KMG555

Workpiece material Werkstückstoff											
Carbon steel Kohlenstoff Stahl	Alloy steel Legierter Stahl	Quenched and tempered steel · Vergüteter Stahl		Hardened steel · Gehärteter Stahl		Stainless steel · Rostfreier Stahl	Cast iron, Nodular cast iron Grauguss GGG	Copper alloy Kupfer Leg	Aluminum alloy Alu Leg	Titanium alloy Titan Leg	Heat resist alloy warmfeste Leg
		~40HRC	~50HRC	~60HRC	~68HRC						
			✓	✓	✓		✓				

● Ex Stock / ab Lager ○ On demand / auf Anfrage

HM-4EFP

4-flute end mills with straight shank and short cutting edge and long neck
4-Schneiden Eckfräser mit kurzer Schneide und Zylinderschaft

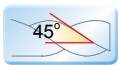
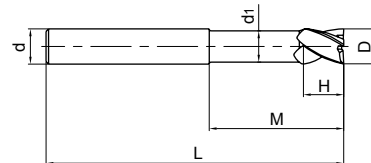
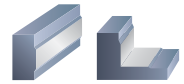

Type Typ	Dimension (mm) Abmessungen						Teeth Zähne Z	Grade Sorte KMG 555
	D	d	H	M	d ₁	L		
HM-4EFP-D6.0	6.0	6	9	30	5.8	75	4	●
HM-4EFP-D8.0	8.0	8	12	40	7.8	100	4	●
HM-4EFP-D10.0	10.0	10	15	50	9.6	100	4	●
HM-4EFP-D12.0	12.0	12	18	50	11.5	100	4	●
HM-4EFP-D16.0	16.0	16	24	50	15.5	150	4	●
HM-4EFP-D20.0	20.0	20	30	60	19.5	150	4	○

B

Solid Carbide end mills
Vollhartmetallschaftfräser

Material Overview · Material Übersicht

✓ = Very suitable · Sehr empfohlen
✓ = Suitable · Empfohlen

KMG555

Workpiece material Werkstückstoff											
Carbon steel Kohlenstoff Stahl	Alloy steel Legierter Stahl	Quenched and tempered steel · Vergüteter Stahl		Hardened steel · Gehärteter Stahl		Stainless steel · Rostfreier Stahl	Cast iron, Nodular cast iron Grauguss GGG	Copper alloy Kupfer Leg	Aluminum alloy Alu Leg	Titanium alloy Titan Leg	Heat resist alloy warmfeste Leg
		~40HRC	~50HRC	~60HRC	~68HRC						
			✓	✓	✓		✓				

Code key **B252,B254**
ISO Kennzeichen

Cutting data **B412-B413**
Schnittdaten

Graphics identification & application **B253,B255**
Graphische Werkzeug- & Anwendungsbeschr.

Order form for non-standard products **B534-B535**
Bestellformular für Sonderwerkzeuge

Recommended cutting data · Empfohlene Schnittdaten

HM-4E | HM-4EL

Workpiece material Werkstückmaterial	Pre-hardened steel, Hardened steel Vergüteter Stahl, Gehärteter Stahl 40~50HRC		Hardened steel Gehärteter Stahl 50~60HRC		Hardened steel Gehärteter Stahl 60~68HRC		
	Diameter Ø Durchmesser (mm)	Rotating Drehzahl (min ⁻¹)	Feed Vorschub (mm/min)	Rotating Drehzahl (min ⁻¹)	Feed Vorschub (mm/min)	Rotating Drehzahl (min ⁻¹)	Feed Vorschub (mm/min)
1		40000	320	40000	320	32000	260
2		40000	800	24000	480	16000	320
3		32000	1020	16000	510	11000	350
4		24000	1250	12000	620	8000	420
5		19000	1360	9500	680	6400	460
6		16000	1540	8000	770	5300	510
8		12000	1540	6000	770	4000	510
10		9600	1540	4800	770	3200	510
12		8000	1600	4000	800	2700	540
14		6800	1340	3400	680	2300	460
16		6000	1200	3000	600	2000	400
18		5300	1060	2700	530	1800	360
20		4800	960	2400	480	1600	320
Max. cutting depth max Schnitttiefe							

1. Please select machine and holder with high precision and rigidity.
2. Vibration and unusual noise may be generated if the machine rigidity and workpiece fixture stability is low, please reduce the rotating speed and feed rate like mentioned above.
3. Please use air blow or MQL (minimum oil mist cooling).
4. Down milling is recommended in side milling.
5. Make overhang as short as possible if no interference.

1. Bitte präzise Maschinen und Werkzeughalter verwenden.
2. Bei Vibrationen oder unüblichen Geräuschen reduzieren Sie die Schnittdaten (wie oben empfohlen) entsprechend.
3. Bitte Luftkühlung oder MQL (Minimalmengen) benutzen.
4. Empfohlene Fräsmethode: Gleichlaufräsen.
5. Werkzeugauskrägung so kurz wie möglich wählen.

Recommended cutting data · Empfohlene Schnittdaten

HM-4EFP

Workpiece material Werkstückmaterial	Pre-hardened steel, Hardened steel Vergüteter Stahl, Gehärteter Stahl 40~50HRC		Hardened steel Gehärteter Stahl 50~60HRC		Hardened steel Gehärteter Stahl 60~68HRC	
	Diameter Ø Durchmesser (mm)	Rotating Drehzahl (min ⁻¹)	Feed Vorschub (mm/min)	Rotating Drehzahl (min ⁻¹)	Feed Vorschub (mm/min)	Rotating Drehzahl (min ⁻¹)
6	16000	1730	8000	920	5300	610
8	12000	1730	6000	920	4000	610
10	9600	1730	4800	920	3200	610
12	8000	1800	4000	960	2700	650
16	6000	1350	3000	720	2000	480
20	4800	1080	2400	570	1600	390
Max. cutting depth max Schnitttiefe	<p>Ae=0.05D Ap=1D Maximum Ae=1.0mm</p>		<p>Ae=0.03D Ap=1D Maximum Ae=0.5mm</p>		<p>Ae=0.02D Ap=1D Maximum Ae=0.3mm</p>	

1. Please select machine and holder with high precision and rigidity.
2. Vibration and unusual noise may be generated if the machine rigidity and workpiece fixture stability is low, please reduce the rotating speed and feed rate like mentioned above.
3. Please use air blow or MQL (minimum oil mist cooling).
4. Down milling is recommended in side milling.
5. Make overhang as short as possible if no interference.

1. Bitte präzise Maschinen und Werkzeughalter verwenden.
2. Bei Vibrationen oder unüblichen Geräuschen reduzieren Sie die Schnittdaten (wie oben empfohlen) entsprechend.
3. Bitte Luftkühlung oder MQL (Minimalmengen) benutzen.
4. Empfohlene Fräsmethode: Gleichlaufräsen.
5. Werkzeugauskragung so kurz wie möglich wählen.

Milling · Fräsen

Solid Carbide end mills · Vollhartmetallschaftfräser

DIN 6527L mills for HSC machining high hardness steel (HRC>48)

DIN 6527L VHM Radiusfräser für die Hartbearbeitung im HSC Bereich (HRC>48)

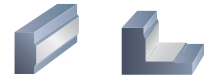

5502R55MHH

KMG405: nano AlTiN Coated Ultra-fine carbide / nano AlTiN beschichtetes Ultrafeinkornhartmetall
For HSC machining of steel (HRC<63) / Für HSC Bearbeitung von Stahl (HRC<63)

KMG555: nano AlTiN Coated super-fine carbide / nano AlTiN beschichtetes Superfeinkornhartmetall
For HSC machining and dry machining of steel (HRC<=70) / Für HSC Bearbeitung und Trockenbearbeitung von Stahl (HRC<=70)

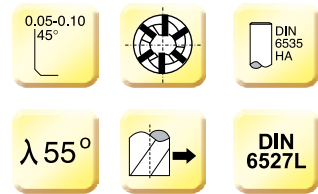
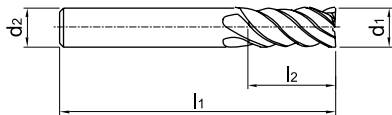

Type Typ	Dimension(mm) Abmessungen				Teeth Zähne	Application Anwendung	H K	
	d1(e8)	d2(h6)	l2	l1			Grade Sorte	KMG555
5502R55MHH-0300	3.00	6	8	57	4		●	●
5502R55MHH-0400	4.00	6	11	57	4		●	○
5502R55MHH-0500	5.00	6	13	57	5		●	○
5502R55MHH-0600	6.00	6	13	57	6		●	○
5502R55MHH-0800	8.00	8	19	63	6		●	○
5502R55MHH-1000	10.00	10	22	72	6		●	○
5502R55MHH-1200	12.00	12	26	83	6		●	○
5502R55MHH-1600	16.00	16	32	92	6		●	○
5502R55MHH-2000	20.00	20	38	104	8		●	○
Art. Group No. / Produktgruppe Nr. :							024130	

Material Overview · Material Übersicht

✓ = Very suitable · Sehr empfohlen
✓ = Suitable · Empfohlen

KMG555

Workpiece material Werkstückstoff											
Carbon steel Kohlenstoff Stahl	Alloy steel Legierter Stahl	Quenched and tempered steel · Vergüteter Stahl		Hardened steel · Gehärteter Stahl		Stainless steel · Rostfreier Stahl	Cast iron, Nodular cast iron Grauguss GGG	Copper alloy Kupfer Leg	Aluminum alloy Alu Leg	Titanium alloy Titan Leg	Heat resist alloy warmfeste Leg
		~40HRC	~50HRC	~60HRC	~68HRC						
		✓	✓	✓	✓		✓				

● Ex Stock / ab Lager ○ On demand / auf Anfrage

HM-6E

6-flute end mills with straight shank
6-Schneiden Schaftfräser mit Zylinderschaft

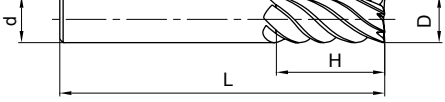

45°

Coated
AlTiN

$\begin{matrix} D \leq 12 & 0 \sim -0.020 \\ 12 < D & 0 \sim -0.030 \end{matrix}$



Type Typ	Dimension(mm) Abmessungen				Teeth Zähne Z	Grade Sorte KMG 555
	D	d	H	L		
HM-6E-D6.0	6.0	6	18	60	6	●
HM-6E-D8.0	8.0	8	20	60	6	●
HM-6E-D10.0	10.0	10	30	75	6	●
HM-6E-D12.0	12.0	12	32	75	6	●
HM-6E-D16.0	16.0	16	40	100	6	●
HM-6E-D20.0	20.0	20	45	100	6	●

B

Solid Carbide end mills
Vollhartmetallschaftfräser

Material Overview · Material Übersicht

✓ = Very suitable · Sehr empfohlen
✓ = Suitable · Empfohlen

KMG555

Workpiece material Werkstückstoff											
Carbon steel Kohlenstoff Stahl	Alloy steel Legierter Stahl	Quenched and tempered steel · Vergüteter Stahl		Hardened steel · Gehärteter Stahl		Stainless steel · Rostfreier Stahl	Cast iron, Nodular cast iron Grauguss GGG	Copper alloy Kupfer Leg	Aluminum alloy Alu Leg	Titanium alloy Titan Leg	Heat resist alloy warmfeste Leg
		~40HRC	~50HRC	~60HRC	~68HRC						
			✓	✓	✓		✓				

Code key **B252,B254**
ISO Kennzeichen

Cutting data **B417-B419**
Schnittdaten

Graphics identification & application **B253,B255**
Graphische Werkzeug- & Anwendungsbeschr.

Order form for non-standard products **B534-B535**
Bestellformular für Sonderwerkzeuge

B415

Milling · Fräsen

Solid Carbide end mills · Vollhartmetallschaftfräser

HM-6EL series for machining high hardness steel · **HM-6EL** Serie für die Hartbearbeitung

6-flute end mills with straight shank and long cutting edges
6-Schneiden Schafffräser mit Zylinderschaft und langer Schneide

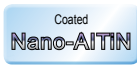
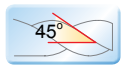
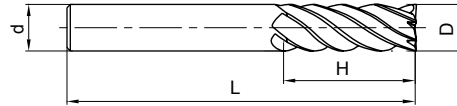
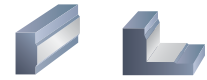

Type Typ	Dimension(mm) Abmessungen				Teeth Zähne Z	Grade Sorte KMG 555
	D	d	H	L		
HM-6EL-D6.0	6.0	6	24	75	6	●
HM-6EL-D8.0	8.0	8	32	75	6	●
HM-6EL-D10.0	10.0	10	40	100	6	●
HM-6EL-D12.0	12.0	12	45	100	6	●
HM-6EL-D16.0	16.0	16	64	150	6	●
HM-6EL-D20.0	20.0	20	75	150	6	●

B

Solid Carbide end mills
Vollhartmetallschaftfräser

Material Overview · Material Übersicht

✓ = Very suitable · Sehr empfohlen
✓ = Suitable · Empfohlen

Workpiece material Werkstückstoff											
Carbon steel Kohlenstoff Stahl	Alloy steel Legierter Stahl	Quenched and tempered steel · Vergüteter Stahl		Hardened steel · Gehärteter Stahl		Stainless steel · Rostfreier Stahl	Cast iron, Nodular cast iron Grauguss GGG	Copper alloy Kupfer Leg	Aluminum alloy Alu Leg	Titanium alloy Titan Leg	Heat resist alloy warmfeste Leg
		~40HRC	~50HRC	~60HRC	~68HRC						
			✓	✓	✓		✓				

● Ex Stock / ab Lager ○ On demand / auf Anfrage

KMG555

Recommended cutting data · Empfohlene Schnittdaten

Type Typ	Grade Sorte	Material Werkstoffe	d ₁ (mm)	z	V _c (m/min)	f _z (mm/z)	a _p (mm)	a _e (mm)	n (min ⁻¹)	V _f (mm/min)
	KMG405	P Steel, steel alloy Stahl, legierter Stahl HRC=42-48	3.00	4	150	0.010	4.50	0.10		
			4.00	4	150	0.015	6.00	0.10		
			5.00	5	150	0.020	7.50	0.10		
			6.00	6	150	0.025	9.00	0.10		
			8.00	6	150	0.032	12.00	0.10		
			10.00	6	150	0.039	15.00	0.10		
			12.00	6	150	0.048	18.00	0.10		
			16.00	6	150	0.058	24.00	0.20		
			20.00	8	150	0.073	30.00	0.20		
		H Steel, steel alloy Stahl, legierter Stahl HRC=48-54	3.00	4	80	0.010	4.50	0.10		
			4.00	4	80	0.015	6.00	0.10		
			5.00	5	80	0.020	7.50	0.10		
			6.00	6	80	0.025	9.00	0.10		
			8.00	6	80	0.032	12.00	0.10		
			10.00	6	80	0.039	15.00	0.10		
			12.00	6	80	0.048	18.00	0.10		
			16.00	6	80	0.058	24.00	0.20		
			20.00	8	80	0.073	30.00	0.20		
		H Hard steel Gehärteter Stahl HRC > 60	3.00	4	30	0.010	4.50	0.10		
			4.00	4	30	0.010	6.00	0.10		
			5.00	5	30	0.014	7.50	0.10		
			6.00	6	30	0.017	9.00	0.10		
			8.00	6	30	0.024	12.00	0.10		
			10.00	6	30	0.030	15.00	0.10		
			12.00	6	30	0.036	18.00	0.10		
			16.00	6	30	0.045	24.00	0.20		
			20.00	8	30	0.057	30.00	0.20		

- Please start a test cutting with 85% of the V_c or 75% of the f_z, then increase the cutting speed and feed rate.
- Please use high precision and high rigidity clamping system. The oscillation of the tool can not be over 0.01 mm.

When the rotating speed of the machine on site cannot reach the maximum rotation speed of the machine used for the calculation of the rotating speed: $V_f = f_z \cdot n \cdot z$ (n: actual rotation of the machine).

- Bitte führen Sie einen Testschnitt mit 85% der V_c und 75% des f_z durch.
Nach erfolgtem Test können Sie die Schnittgeschwindigkeit bzw. die Vorschubwerte entsprechend erhöhen.
- Bitte verwenden Sie nur Spannmittel mit einer hohen Genauigkeit und einer hohen Spannkraft.
Überprüfen Sie den Rundlauf der Werkzeuge. Sie sollten darauf achten, dass der Rundlauffehler nicht größer als 0.01 mm ist.

Sollten Sie aufgrund der Machinendrehzahl nicht in der Lage sein, die angegebenen Drehzahlen ein zuhalten, achten Sie darauf, dass Sie die V_f entsprechend anpassen. $V_f = f_z \cdot n \cdot z$ (n: aktuelle Machinendrehzahl).

Milling - Fräsen

Solid Carbide end mills - Vollhartmetallschaftfräser

Recommended cutting data - Empfohlene Schnittdaten

HM-6E

Workpiece material Werkstückstoff	Pre-hardened steel, Hardened steel Vergüteter Stahl, Gehärteter Stahl 40~50HRC		Hardened steel Gehärteter Stahl 50~60HRC		Hardened steel Gehärteter Stahl 60~68HRC	
Cutting speed Schnittgeschw.	300m/min		150m/min		100m/min	
Diameter Ø Durchmesser (mm)	Rotating Drehzahl (min ⁻¹)	Feed Vorschub (mm/min)	Rotating Drehzahl (min ⁻¹)	Feed Vorschub (mm/min)	Rotating Drehzahl (min ⁻¹)	Feed Vorschub (mm/min)
6	16000	1850	8000	925	5300	610
8	12000	1850	6000	925	4000	610
10	9600	1850	4800	925	3200	610
12	8000	1920	4000	960	2700	650
14	6800	1600	3400	815	2300	550
16	6000	1440	3000	720	2000	480
18	5300	1270	2700	635	1800	430
20	4800	1150	2400	575	1600	385
Max. cutting depth max Schnitttiefe	<p>Ae=0.05D Ap=1.5D Maximum Ae=1.0mm</p>		<p>Ae=0.03D Ap=1.5D Maximum Ae=0.5mm</p>		<p>Ae=0.02D Ap=1.5D Maximum Ae=0.3mm</p>	

1. Please select machine and holder with high precision and rigidity.
2. Vibration and unusual noise may be generated if the machine rigidity and workpiece fixture stability is low, please reduce the rotating speed and feed rate like mentioned above.
3. Please use air blow or MQL (minimum oil mist cooling).
4. Down milling is recommended in side milling.
5. Make overhang as short as possible if no interference.

1. Bitte präzise Maschinen und Werkzeughalter verwenden.
2. Bei Vibrationen oder unüblichen Geräuschen reduzieren Sie die Schnittdaten (wie oben empfohlen) entsprechend.
3. Bitte Luftkühlung oder MQL (Minimalmengen) benutzen.
4. Empfohlene Fräsmethode: Gleichlaufräsen.
5. Werkzeugauskragung so kurz wie möglich wählen.

B

Solid Carbide end mills
Vollhartmetallschaftfräser

Recommended cutting data · Empfohlene Schnittdaten

HM-6EL

Workpiece material Werkstückstoff	Pre-hardened steel, Hardened steel Vergüteter Stahl, Gehärteter Stahl 40~50HRC		Hardened steel Gehärteter Stahl 50~60HRC		Hardened steel Gehärteter Stahl 60~68HRC	
Cutting speed Schnittgeschw.	300m/min		150m/min		100m/min	
Diameter Ø Durchmesser (mm)	Rotating Drehzahl (min ⁻¹)	Feed Vorschub (mm/min)	Rotating Drehzahl (min ⁻¹)	Feed Vorschub (mm/min)	Rotating Drehzahl (min ⁻¹)	Feed Vorschub (mm/min)
6	16000	1300	8000	650	5300	430
8	12000	1300	6000	650	4000	430
10	9600	1300	4800	650	3200	430
12	8000	1350	4000	670	2700	460
14	6800	1150	3400	570	2300	380
16	6000	1000	3000	500	2000	340
18	5300	890	2700	450	1800	300
20	4800	800	2400	400	1600	270
Max. cutting depth max Schnitttiefe	<p>Ae=0.02D Ap=3D Maximum Ae=0.3mm</p>		<p>Ae=0.01D Ap=3D</p>			

1. Please select machine and holder with high precision and rigidity.
2. Vibration and unusual noise may be generated if the machine rigidity and workpiece fixture stability is low, please reduce the rotating speed and feed rate like mentioned above.
3. Please use air blow or MQL (minimum oil mist cooling).
4. Down milling is recommended in side milling.
5. Make overhang as short as possible if no interference.

1. Bitte präzise Maschinen und Werkzeughalter verwenden.
2. Bei Vibrationen oder unüblichen Geräuschen reduzieren Sie die Schnittdaten (wie oben empfohlen) entsprechend.
3. Bitte Luftkühlung oder MQL (Minimalmengen) benutzen.
4. Empfohlene Fräsmethode: Gleichlaufräsen.
5. Werkzeugauskragung so kurz wie möglich wählen.

Milling · Fräsen

Solid Carbide end mills · Vollhartmetallschaftfräser

ZCC CT 2-flute ball nose end mills for HSC machining high hardness steel (HRC>48) short

ZCC CT 2-Schneiden VHM Vollradiusfräser für Hartbearbeitung im HSC Bereich (HRC>48) kurz

5565R302GH

KMG405: nano AlTiN Coated Ultra-fine carbide / nano AlTiN beschichtetes Ultrafeinkornhartmetall

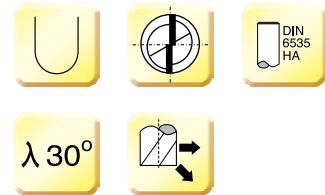
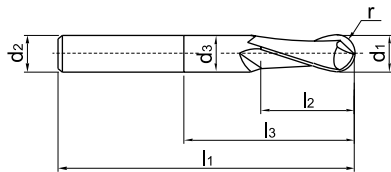

B

Solid Carbide end mills
Vollhartmetallschaftfräser

Type Typ	Dimension(mm) Abmessungen								Teeth Zähne	Application Anwendung	P	K	H
	d1	d2(h6)	l2	l1	d3	l3	r(f8)	α°					
5565R302GH-0300	3.00	6	4	57	2.80	9	1.50	6	2				○
5565R302GH-0400	4.00	6	5	57	3.70	12	2.00	4	2				●
5565R302GH-0500	5.00	6	6	57	4.60	15	2.50	2	2				●
5565R302GH-0600	6.00	6	7	57	5.50	20	3.00	-	2				●
5565R302GH-0800	8.00	8	9	63	7.40	26	4.00	-	2				●
5565R302GH-1000	10.00	10	11	72	9.20	31	5.00	-	2				●
5565R302GH-1200	12.00	12	12	83	11.00	37	6.00	-	2				●
5565R302GH-1600	16.00	16	16	92	15.00	43	8.00	-	2				●

Art. Group No. / Produktgruppe Nr. : 025130

KMG555

Material Overview · Material Übersicht

✓ = Very suitable · Sehr empfohlen
✓ = Suitable · Empfohlen

Workpiece material Werkstückstoff											
Carbon steel Kohlenstoff Stahl	Alloy steel Legierter Stahl	Quenched and tempered steel · Vergüteter Stahl		Hardened steel · Gehärteter Stahl		Stainless steel · Rostfreier Stahl	Cast iron, Nodular cast iron Grauguss GGG	Copper alloy Kupfer Leg	Aluminum alloy Alu Leg	Titanium alloy Titan Leg	Heat resist alloy warmfeste Leg
		~40HRC	~50HRC	~60HRC	~68HRC						
		✓	✓	✓			✓				

● Ex Stock / ab Lager ○ On demand / auf Anfrage

ZCC CT 2-flute ball nose end mills for HSC machining high hardness steel (HRC>48) lang

ZCC CT 2-Schneiden VHM Vollradiusfräser für Hartbearbeitung im HSC Bereich (HRC>48) lang

5566R302GH

KMG405: nano AlTiN Coated Ultra-fine carbide / nano AlTiN beschichtetes Ultrafeinkornhartmetall

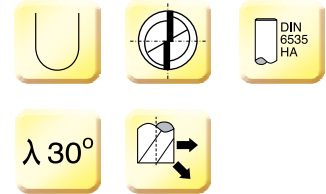
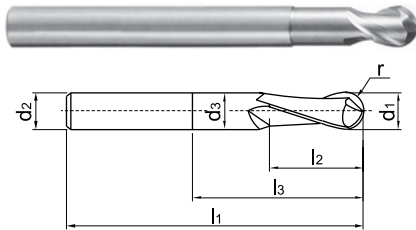

Type Typ	Dimension(mm) Abmessungen								Teeth Zähne	Application Anwendung	Grade Sorte	P K H
	d1	d2(h6)	l2	l1	d3	l3	r(fs)	α°				
5566R302GH-0300	3.00	6	4	75	2.80	15	1.50	6	2			●
5566R302GH-0400	4.00	6	5	75	3.70	20	2.00	4	2			●
5566R302GH-0500	5.00	6	6	80	4.60	25	2.50	2	2			●
5566R302GH-0600	6.00	6	7	80	5.50	30	3.00	-	2			●
5566R302GH-0800	8.00	8	9	90	7.40	35	4.00	-	2			●
5566R302GH-1000	10.00	10	11	100	9.20	40	5.00	-	2			●
5566R302GH-1200	12.00	12	12	120	11.00	50	6.00	-	2			●

Art. Group No. / Produktgruppe Nr. :

025130

B

Solid Carbide end mills
Vollhartmetallschaftfräser

Material Overview · Material Übersicht

✓ = Very suitable · Sehr empfohlen
✓ = Suitable · Empfohlen

KMG405

Workpiece material Werkstückstoff											
Carbon steel Kohlenstoff Stahl	Alloy steel Legierter Stahl	Quenched and tempered steel · Vergüteter Stahl		Hardened steel · Gehärteter Stahl		Stainless steel · Rostfreier Stahl	Cast iron, Nodular cast iron Grauguss GGG	Copper alloy Kupfer Leg	Aluminum alloy Alu Leg	Titanium alloy Titan Leg	Heat resist alloy warmfeste Leg
		~40HRC	~50HRC	~60HRC	~68HRC						
		✓	✓	✓			✓				

Code key B252,B254
ISO Kennzeichen

Cutting data B427-B431
Schnittdaten

Graphics identification & application B253,B255
Graphische Werkzeug- & Anwendungsbeschr.

Order form for non-standard products B534-B535
Bestellformular für Sonderwerkzeuge

B421

Milling · Fräsen

Solid Carbide end mills · Vollhartmetallschaftfräser

ZCC CT 2-flute ball nose end mills for HSC machining high hardness steel (HRC>48)

ZCC CT 2-Schneiden VHM Kugelkopffräser für Hartbearbeitung im HSC Bereich (HRC>48)

5565R302HH

KMG405: nano AlTiN Coated Ultra-fine carbide / nano AlTiN beschichtetes Ultrafeinkornhartmetall

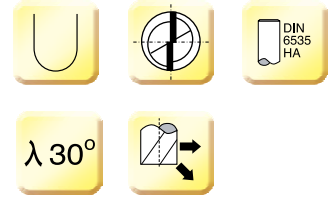
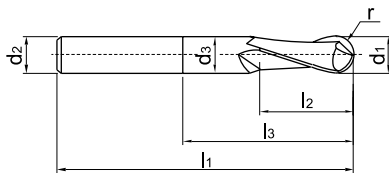

Type Typ	Dimension(mm) Abmessungen								Teeth Zähne	Application Anwendung	P K H
	d1	d2(h6)	l2	l1	d3	l3	r(fs)	α°			
5565R302HH-0300	3.00	6	4	57	2.80	9	1.50	6	2		●
5565R302HH-0400	4.00	6	5	57	3.70	12	2.00	4	2		●
5565R302HH-0500	5.00	6	6	57	4.60	15	2.50	2	2		●
5565R302HH-0600	6.00	6	7	57	5.50	20	3.00	-	2		●
5565R302HH-0800	8.00	8	9	63	7.40	26	4.00	-	2		●
5565R302HH-1000	10.00	10	11	72	9.20	31	5.00	-	2		●
5565R302HH-1200	12.00	12	12	83	11.00	37	6.00	-	2		●
5565R302HH-1600	16.00	16	16	92	15.00	43	8.00	-	2		●

Art. Group No. / Produktgruppe Nr. :

026130

Material Overview · Material Übersicht

✓ = Very suitable · Sehr empfohlen
 ✓ = Suitable · Empfohlen

KMG405

Workpiece material Werkstückstoff											
Carbon steel Kohlenstoff Stahl	Alloy steel Legierter Stahl	Quenched and tempered steel · Vergüteter Stahl		Hardened steel · Gehärteter Stahl		Stainless steel · Rostfreier Stahl	Cast iron, Nodular cast iron Grauguss GGG	Copper alloy Kupfer Leg	Aluminum alloy Alu Leg	Titanium alloy Titan Leg	Heat resist alloy warmfeste Leg
		~40HRC	~50HRC	~60HRC	~68HRC						
		✓	✓	✓	✓		✓				

● Ex Stock / ab Lager ○ On demand / auf Anfrage

ZCC CT 2-flute ball nose end mills for HSC machining high hardness steel (HRC>48)

ZCC CT 2-Schneiden VHM Kugelkopffräser für Hartbearbeitung im HSC Bereich (HRC>48)



5566R302HH

KMG405: nano AlTiN Coated Ultra-fine carbide / nano AlTiN beschichtetes Ultrafeinkornhartmetall

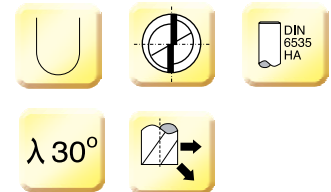
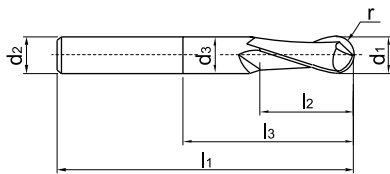

Type Typ	Dimension(mm) Abmessungen								Teeth Zähne	Application Anwendung	P K H
	d1	d2(h6)	l2	l1	d3	l3	r(fs)	α°			
5566R302HH-0300	3.00	6	4	75	2.80	15	1.50	6	2		●
5566R302HH-0400	4.00	6	5	75	3.70	20	2.00	4	2		●
5566R302HH-0500	5.00	6	6	80	4.60	25	2.50	2	2		●
5566R302HH-0600	6.00	6	7	80	5.50	30	3.00	-	2		●
5566R302HH-0800	8.00	8	9	90	7.40	35	4.00	-	2		●
5566R302HH-1000	10.00	10	11	100	9.20	40	5.00	-	2		●
5566R302HH-1200	12.00	12	12	120	11.00	50	6.00	-	2		●

Art. Group No. / Produktgruppe Nr. : **026130**

B

Solid Carbide end mills
Vollhartmetallschaftfräser

Material Overview · Material Übersicht

✓ = Very suitable · Sehr empfohlen
✓ = Suitable · Empfohlen

KMG405

Workpiece material Werkstückstoff											
Carbon steel Kohlenstoff Stahl	Alloy steel Legierter Stahl	Quenched and tempered steel · Vergüteter Stahl		Hardened steel · Gehärteter Stahl		Stainless steel · Rostfreier Stahl	Cast iron, Nodular cast iron Grauguss GGG	Copper alloy Kupfer Leg	Aluminum alloy Alu Leg	Titanium alloy Titan Leg	Heat resist alloy warmfeste Leg
		~40HRC	~50HRC	~60HRC	~68HRC						
		✓	✓	✓	✓		✓				

Code key **B252,B254**
ISO Kennzeichen

Cutting data **B427-B431**
Schnittdaten

Graphics identification & application **B253,B255**
Graphische Werkzeug- & Anwendungsbeschr.

Order form for non-standard products **B534-B535**
Bestellformular für Sonderwerkzeuge

B423

Milling · Fräsen

Solid Carbide end mills · Vollhartmetallschaftfräser

HM-2B series machining high hardness steel · HM-2B Serie für die Hartbearbeitung

2-flute ball nose end mills with straight shank
2-Schneiden Kugelkopffräser mit Zylinderschaft

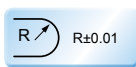
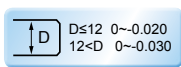
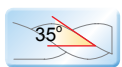
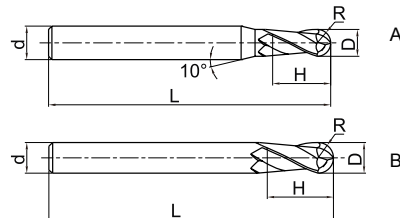

Type Typ	Dimension (mm) Abmessungen					Teeth Zähne Z	Geometry Ausführung	Grade Sorte KMG 555
	D	R	d	H	L			
HM-2B-R0.5S	1.0	0.5	4.0	2.0	50	2	A	●
HM-2B-R0.75S	1.5	0.75	4.0	3.0	50	2	A	●
HM-2B-R1.0S	2.0	1.0	4.0	4.0	50	2	A	●
HM-2B-R1.25S	2.5	1.25	4.0	5.0	50	2	A	●
HM-2B-R1.5S	3.0	1.5	4.0	6.0	50	2	A	●
HM-2B-R2.0S	4.0	2.0	4.0	8.0	50	2	B	●
HM-2B-R0.5	1.0	0.5	6.0	2.0	50	2	A	●
HM-2B-R0.75	1.5	0.75	6.0	3.0	50	2	A	●
HM-2B-R1.0	2.0	1.0	6.0	4.0	50	2	A	●
HM-2B-R1.25	2.5	1.25	6.0	5.0	50	2	A	●
HM-2B-R1.5	3.0	1.5	6.0	6.0	50	2	A	●
HM-2B-R1.75	3.5	1.75	6.0	8.0	50	2	A	●
HM-2B-R2.0	4.0	2.0	6.0	8.0	50	2	A	●
HM-2B-R2.5	5.0	2.5	6.0	10.0	50	2	A	●
HM-2B-R2.75	5.5	2.75	6.0	12.0	50	2	A	●
HM-2B-R3.0	6.0	3.0	6.0	12.0	50	2	B	●
HM-2B-R3.5	7.0	3.5	8.0	14.0	60	2	A	●
HM-2B-R4.0	8.0	4.0	8.0	16.0	60	2	B	●
HM-2B-R4.5	9.0	4.5	10.0	18.0	75	2	A	●
HM-2B-R5.0	10.0	5.0	10.0	20.0	75	2	B	●
HM-2B-R6.0	12.0	6.0	12.0	24.0	75	2	B	●
HM-2B-R7.0	14.0	7.0	14.0	28.0	75	2	B	●
HM-2B-R8.0	16.0	8.0	16.0	32.0	100	2	B	●
HM-2B-R10.0	20.0	10.0	20.0	40.0	100	2	B	●

Material Overview · Material Übersicht

✓ = Very suitable · Sehr empfohlen
✓ = Suitable · Empfohlen

KMG555

		Workpiece material Werkstückstoff									
Carbon steel Kohlenstoff Stahl	Alloy steel Legierter Stahl	Quenched and tempered steel · Vergüteter Stahl		Hardened steel · Gehärteter Stahl		Stainless steel · Rostfreier Stahl	Cast iron, Nodular cast iron Grauguss GGG	Copper alloy Kupfer Leg	Aluminum alloy Alu Leg	Titanium alloy Titan Leg	Heat resist alloy warmfeste Leg
		~40HRC	~50HRC	~60HRC	~68HRC						
		✓	✓	✓			✓				

● Ex Stock / ab Lager ○ On demand / auf Anfrage

HM-2BL series for machining high hardness steel · **HM-2BL** Serie für die Hartbearbeitung

2-flute ball nose end mills with long straight shank
2-Schneiden Nutenfräser mit langem Zylinderschaft

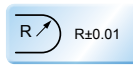
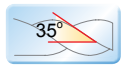
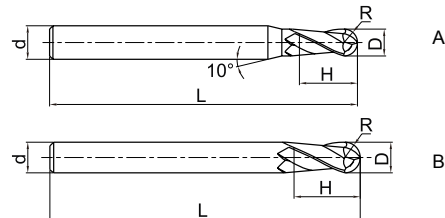

Type Typ	Dimension(mm) Abmessungen					Teeth Zähne Z	Geometry Ausführung	Grade Sorte KMG 555
	D	R	d	H	L			
HM-2BL-R1.0	2.0	1.0	6.0	4.0	75	2	A	●
HM-2BL-R1.25	2.5	1.25	6.0	6.0	75	2	A	●
HM-2BL-R1.5	3.0	1.5	6.0	6.0	75	2	A	●
HM-2BL-R1.75	3.5	1.75	6.0	8.0	75	2	A	●
HM-2BL-R2.0	4.0	2.0	6.0	8.0	75	2	A	●
HM-2BL-R2.5	5.0	2.5	6.0	10.0	75	2	A	●
HM-2BL-R2.75	5.5	2.75	6.0	12.0	75	2	A	●
HM-2BL-R3.0	6.0	3.0	6.0	12.0	75	2	B	●
HM-2BL-R3.5	7.0	3.5	8.0	14.0	75	2	A	●
HM-2BL-R4.0	8.0	4.0	8.0	16.0	100	2	B	●
HM-2BL-R4.5	9.0	4.5	10.0	18.0	100	2	A	●
HM-2BL-R5.0	10.0	5.0	10.0	20.0	100	2	B	●
HM-2BL-R6.0	12.0	6.0	12.0	24.0	100	2	B	●
HM-2BL-R7.0	14.0	7.0	14.0	28.0	100	2	B	●
HM-2BL-R8.0	16.0	8.0	16.0	32.0	150	2	B	●
HM-2BL-R10.0	20.0	10.0	20.0	40.0	150	2	B	●

Material Overview · Material Übersicht

✓ = Very suitable · Sehr empfohlen
✓ = Suitable · Empfohlen

KMG555

Workpiece material Werkstückstoff											
Carbon steel Kohlenstoff Stahl	Alloy steel Legierter Stahl	Quenched and tempered steel · Vergüteter Stahl		Hardened steel · Gehärteter Stahl		Stainless steel · Rostfreier Stahl	Cast iron, Nodular cast iron Grauguss GGG	Copper alloy Kupfer Leg	Aluminum alloy Alu Leg	Titanium alloy Titan Leg	Heat resist alloy warmfeste Leg
		~40HRC	~50HRC	~60HRC	~68HRC						
			✓	✓	✓		✓				

Code key **B252,B254**
ISO Kennzeichen

Cutting data **B427-B431**
Schnittdaten

Graphics identification & application **B253,B255**
Graphische Werkzeug- & Anwendungsbeschr.

Order form for non-standard products **B534-B535**
Bestellformular für Sonderwerkzeuge

Milling · Fräsen

Solid Carbide end mills · Vollhartmetallschaftfräser

HM-2BFP series for machining high hardness steel · **HM-2BFP** Serie für die Hartbearbeitung

2-flute ball nose mills with long straight shank
2-Schneiden Kugelkopffräser mit langem Zylinderschaft

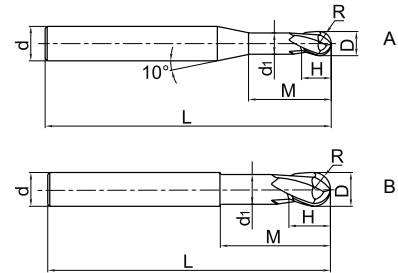

Type Typ	Dimension(mm) Abmessungen							Teeth Zähne Z	Geometry Ausführung	Grade Sorte KMG 555
	D	R	H	d ₁	M	d	L			
HM-2BFP-R0.5	1.0	0.5	1.0	0.95	2.5	6	75	2	A	●
HM-2BFP-R0.75	1.5	0.75	1.5	1.45	3.0	6	75	2	A	●
HM-2BFP-R1.0	2.0	1.0	2.0	1.95	4.0	6	75	2	A	●
HM-2BFP-R1.5	3.0	1.5	3.0	2.85	6.0	6	75	2	A	●
HM-2BFP-R2.0	4.0	2.0	4.0	3.85	8.0	6	75	2	A	●
HM-2BFP-R2.5	5.0	2.5	5.0	4.85	10.0	6	75	2	A	●
HM-2BFP-R3.0	6.0	3.0	6.0	5.8	12.0	6	75	2	B	●
HM-2BFP-R4.0	8.0	4.0	8.0	7.8	16.0	8	100	2	B	●
HM-2BFP-R5.0	10.0	5.0	10	9.6	20.0	10	100	2	B	●
HM-2BFP-R6.0	12.0	6.0	12	11.5	24.0	12	100	2	B	●
HM-2BFP-R8.0	16.0	8.0	16	15.5	32.0	16	150	2	B	●
HM-2BFP-R10.0	20.0	10.0	20	19.5	40.0	20	150	2	B	●

B

Solid Carbide end mills
Vollhartmetallschaftfräser

Material Overview · Material Übersicht



✓ = Very suitable · Sehr empfohlen
✓ = Suitable · Empfohlen

KMG555

Workpiece material Werkstückstoff											
Carbon steel Kohlenstoff Stahl	Alloy steel Legierter Stahl	Quenched and tempered steel · Vergüteter Stahl		Hardened steel · Gehärteter Stahl		Stainless steel · Rostfreier Stahl	Cast iron, Nodular cast iron Grauguss GGG	Copper alloy Kupfer Leg	Aluminum alloy Alu Leg	Titanium alloy Titan Leg	Heat resist alloy warmfeste Leg
		~40HRC	~50HRC	~60HRC	~68HRC						
			✓	✓	✓		✓				

● Ex Stock / ab Lager ○ On demand / auf Anfrage

Recommended cutting data · Empfohlene Schnittdaten

Type Typ	Grade Sorte	Material Werkstoffe	d ₁ (mm)	z	V _c (m/min)	f _z (mm/z)	a _p (mm)	a _e (mm)	d _{eff} (mm)	n (min ⁻¹)	V _f (mm/min)	
 	KMG405	P Steel, steel alloy Stahl, legierter Stahl HRC=42-48	3.00	2	220	0.060	0.09	0.18	1.02			
			4.00	2	220	0.080	0.12	0.24	1.36			
			5.00	2	220	0.100	0.15	0.30	1.71			
			6.00	2	220	0.090	0.18	0.36	2.05			
			8.00	2	220	0.120	0.24	0.48	2.73			
			10.00	2	220	0.150	0.30	0.60	3.41			
			12.00	2	220	0.120	0.36	0.72	4.09			
		16.00	2	220	0.120	0.48	0.96	5.46				
		K Cast iron Guss	3.00	2	280	0.060	0.09	0.18	1.02			
			4.00	2	280	0.080	0.12	0.24	1.36			
			5.00	2	280	0.100	0.15	0.30	1.71			
			6.00	2	280	0.090	0.18	0.36	2.05			
			8.00	2	280	0.120	0.24	0.48	2.73			
			10.00	2	280	0.150	0.30	0.60	3.41			
			12.00	2	280	0.120	0.36	0.72	4.09			
		16.00	2	280	0.120	0.48	0.96	5.46				
		H	Steel, steel alloy Stahl, legierter Stahl HRC=48-54	3.00	2	180	0.060	0.09	0.18	1.02		
				4.00	2	180	0.080	0.12	0.24	1.36		
				5.00	2	180	0.100	0.15	0.30	1.71		
				6.00	2	180	0.090	0.18	0.36	2.05		
				8.00	2	180	0.120	0.24	0.48	2.73		
				10.00	2	180	0.150	0.30	0.60	3.41		
				12.00	2	180	0.120	0.36	0.72	4.09		
			16.00	2	180	0.120	0.48	0.96	5.46			
			Hard steel Gehärteter Stahl HRC > 60	3.00	2	80	0.060	0.09	0.18	1.02		
				4.00	2	80	0.080	0.12	0.24	1.36		
				5.00	2	80	0.100	0.15	0.30	1.71		
				6.00	2	80	0.090	0.18	0.36	2.05		
8.00	2			80	0.120	0.24	0.48	2.73				
10.00	2			80	0.150	0.30	0.60	3.41				
12.00	2	80		0.120	0.36	0.72	4.09					
16.00	2	80	0.120	0.48	0.96	5.46						

- Please start a test cutting with 85% of the V_c or 75% of the f_z, then increase the cutting speed and feed rate.
- Please use high precision and high rigidity clamping system. The oscillation of the tool can not be over 0.01 mm.

$$N = 1000V_c / d_{eff} / 3.14159$$



When the rotating speed of the machine on site cannot reach the maximum rotation speed of the machine used for the calculation of the rotating speed: $V_f = f_z * n * z$ (n: actual rotation of the machine).

- Bitte führen Sie einen Testschnitt mit 85% der V_c und 75% des f_z durch.
 - Nach erfolgreichem Test können Sie die Schnittgeschwindigkeit bzw. die Vorschubwerte entsprechend erhöhen.
 - Bitte verwenden Sie nur Spannmittel mit einer hohen Genauigkeit und einer hohen Spannkraft.
 - Überprüfen Sie den Rundlauf der Werkzeuge. Sie sollten darauf achten, dass der Rundlauffehler nicht größer als 0.01 mm ist.
- $$N = 1000V_c / d_{eff} / 3.14159$$
- Sollten Sie aufgrund der Machinendrehzahl nicht in der Lage sein, die angegebenen Drehzahlen ein zu halten, achten Sie darauf, dass Sie die V_f entsprechend anpassen. $V_f = f_z * n * z$ (n: aktuelle Machinendrehzahl).

Milling - Fräsen

Solid Carbide end mills - Vollhartmetallschaftfräser

Recommended cutting data - Empfohlene Schnittdaten

Type Typ	Grade Sorte	Material Werkstoffe	d ₁ (mm)	z	V _c (m/min)	f _z (mm/z)	a _p (mm)	a _e (mm)	d _{eff} (mm)	n (min ⁻¹)	V _f (mm/min)
 	KMG405	P Steel, steel alloy Stahl, legierter Stahl HRC=42-48	3.00	2	220	0.060	0.06	0.18	0.84		
			4.00	2	220	0.080	0.08	0.24	1.12		
			5.00	2	220	0.100	0.10	0.30	1.40		
			6.00	2	220	0.090	0.12	0.36	1.68		
			8.00	2	220	0.120	0.16	0.48	2.24		
			10.00	2	220	0.150	0.20	0.60	2.80		
		12.00	2	220	0.120	0.24	0.72	3.36			
		K Cast iron Guss	3.00	2	280	0.060	0.06	0.18	0.84		
			4.00	2	280	0.080	0.08	0.24	1.12		
			5.00	2	280	0.100	0.10	0.30	1.40		
			6.00	2	280	0.090	0.12	0.36	1.68		
			8.00	2	280	0.120	0.16	0.48	2.24		
			10.00	2	280	0.150	0.20	0.60	2.80		
		H Steel, steel alloy Stahl, legierter Stahl HRC=48-54	3.00	2	180	0.060	0.06	0.18	0.84		
			4.00	2	180	0.080	0.08	0.24	1.12		
			5.00	2	180	0.100	0.10	0.30	1.40		
			6.00	2	180	0.090	0.12	0.36	1.68		
			8.00	2	180	0.120	0.16	0.48	2.24		
			10.00	2	180	0.150	0.20	0.60	2.80		
		H Hard steel Gehärteter Stahl HRC > 60	3.00	2	80	0.060	0.06	0.18	0.84		
			4.00	2	80	0.080	0.08	0.24	1.12		
			5.00	2	80	0.100	0.10	0.30	1.40		
			6.00	2	80	0.090	0.12	0.36	1.68		
			8.00	2	80	0.120	0.16	0.48	2.24		
10.00	2		80	0.150	0.20	0.60	2.80				
			12.00	2	80	0.120	0.24	0.72	3.36		



- Please start a test cutting with 85% of the V_c or 75% of the f_z, then increase the cutting speed and feed rate.
- Please use high precision and high rigidity clamping system. The oscillation of the tool can not be over 0.01 mm.
 $N = 1000V_c / d_{eff} / 3.14159$
 When the rotating speed of the machine on site cannot reach the maximum rotation speed of the machine used for the calculation of the rotating speed: $V_f = f_z * n * z$ (n: actual rotation of the machine).

- Bitte führen Sie einen Testschnitt mit 85% der V_c und 75% des f_z durch.
 Nach erfolgtem Test können Sie die Schnittgeschwindigkeit bzw. die Vorschubwerte entsprechend erhöhen.
- Bitte verwenden Sie nur Spannmittel mit einer hohen Genauigkeit und einer hohen Spannkraft.
 Überprüfen Sie den Rundlauf der Werkzeuge. Sie sollten darauf achten, dass der Rundlauffehler nicht größer als 0.01 mm ist.
 $N = 1000V_c / d_{eff} / 3.14159$
 Sollten Sie aufgrund der Machinendrehzahl nicht in der Lage sein, die angegebenen Drehzahlen einzuhalten, achten Sie darauf, dass Sie die V_f entsprechend anpassen. $V_f = f_z * n * z$ (n: aktuelle Machinendrehzahl).

B

Solid Carbide end mills
Vollhartmetallschaftfräser

Recommended cutting data · Empfohlene Schnittdaten

Type Typ	Grade Sorte	Material Werkstoffe	d ₁ (mm)	z	V _c (m/min)	f _z (mm/z)	a _p (mm)	a _e (mm)	d _{eff} (mm)	n (min ⁻¹)	V _f (mm/min)	
 	KMG405	K Cast iron Guss	3	2	280	0.060	0.09	0.18	1.02			
			4	2	280	0.080	0.12	0.24	1.36			
			5	2	280	0.100	0.15	0.30	1.71			
			6	2	280	0.090	0.18	0.36	2.05			
			8	2	280	0.120	0.24	0.48	2.73			
			10	2	280	0.150	0.30	0.60	3.41			
			12	2	280	0.120	0.36	0.72	4.09			
			16	2	280	0.120	0.48	0.96	5.46			
		H	Hard steel Gehärteter Stahl HRC=48-54	3	2	180	0.060	0.09	0.18	1.02		
				4	2	180	0.080	0.12	0.24	1.36		
				5	2	180	0.100	0.15	0.30	1.71		
				6	2	180	0.090	0.18	0.36	2.05		
				8	2	180	0.120	0.24	0.48	2.73		
				10	2	180	0.150	0.30	0.60	3.41		
				12	2	180	0.120	0.36	0.72	4.09		
				16	2	180	0.120	0.48	0.96	5.46		
			Hard steel Gehärteter Stahl HRC > 60	3	2	80	0.060	0.09	0.18	1.02		
				4	2	80	0.080	0.12	0.24	1.36		
				5	2	80	0.100	0.15	0.30	1.71		
				6	2	80	0.090	0.18	0.36	2.05		
				8	2	80	0.120	0.24	0.48	2.73		
				10	2	80	0.150	0.30	0.60	3.41		
				12	2	80	0.120	0.36	0.72	4.09		
				16	2	80	0.120	0.48	0.96	5.46		

- Please start a test cutting with 85% of the V_c or 75% of the f_z, then increase the cutting speed and feed rate.
- Please use high precision and high rigidity clamping system. The oscillation of the tool can not be over 0.01 mm.

$$N = 1000V_c / d_{eff} / 3.14159$$

When the rotating speed of the machine on site cannot reach the maximum rotation speed of the machine used for the calculation of the rotating speed: $V_f = f_z * n * z$ (n: actual rotation of the machine).



- Bitte führen Sie einen Testschnitt mit 85% der V_c und 75% des f_z durch.
- Nach erfolgtem Test können Sie die Schnittgeschwindigkeit bzw. die Vorschubwerte entsprechend erhöhen.
- Bitte verwenden Sie nur Spannmittel mit einer hohen Genauigkeit und einer hohen Spannkraft.
- Überprüfen Sie den Rundlauf der Werkzeuge. Sie sollten darauf achten, dass der Rundlauffehler nicht größer als 0.01 mm ist.

Sollten Sie aufgrund der Machinendrehzahl nicht in der Lage sein, die angegebenen Drehzahlen ein zuhalten, achten Sie darauf, dass Sie die V_f entsprechend anpassen. $V_f = f_z * n * z$ (n: aktuelle Machinendrehzahl).

Milling - Fräsen

Solid Carbide end mills - Vollhartmetallschaftfräser

Recommended cutting data - Empfohlene Schnittdaten

Type Typ	Grade Sorte	Material Werkstoffe	d1 (mm)	z	Vc (m/min)	fz (mm/z)	ap (mm)	ae (mm)	d _{eff} (mm)	n (min ⁻¹)	V _f (mm/min)
 	KMG405	K Cast iron Guss	3	2	280	0.060	0.06	0.18	0.84		
			4	2	280	0.080	0.08	0.24	1.12		
			5	2	280	0.100	0.10	0.30	1.40		
			6	2	280	0.090	0.12	0.36	1.68		
			8	2	280	0.120	0.16	0.48	2.24		
			10	2	280	0.150	0.20	0.60	2.80		
		12	2	280	0.120	0.24	0.72	3.36			
		H Hard steel Gehärteter Stahl HRC=48-54	3	2	180	0.060	0.06	0.18	0.84		
			4	2	180	0.080	0.08	0.24	1.12		
			5	2	180	0.100	0.10	0.30	1.40		
			6	2	180	0.090	0.12	0.36	1.68		
			8	2	180	0.120	0.16	0.48	2.24		
			10	2	180	0.150	0.20	0.60	2.80		
		12	2	180	0.120	0.24	0.72	3.36			
		H Hard steel Gehärteter Stahl HRC > 60	3	2	80	0.060	0.06	0.18	0.84		
			4	2	80	0.080	0.08	0.24	1.12		
			5	2	80	0.100	0.10	0.30	1.40		
			6	2	80	0.090	0.12	0.36	1.68		
			8	2	80	0.120	0.16	0.48	2.24		
			10	2	80	0.150	0.20	0.60	2.80		
		12	2	80	0.120	0.24	0.72	3.36			

- Please start a test cutting with 85% of the Vc or 75% of the fz, then increase the cutting speed and feed rate.
- Please use high precision and high rigidity clamping system. The oscillation of the tool can not be over 0.01 mm.

$$N = 1000V_c / d_{eff} / 3.14159$$

When the rotating speed of the machine on site cannot reach the maximum rotation speed of the machine used for the calculation of the rotating speed: $V_f = f_z * n * z$ (n: actual rotation of the machine).

- Bitte führen Sie einen Testschnitt mit 85% der Vc und 75% des fz durch.
Nach erfolgtem Test können Sie die Schnittgeschwindigkeit bzw. die Vorschubwerte entsprechend erhöhen.
- Bitte verwenden Sie nur Spannmittel mit einer hohen Genauigkeit und einer hohen Spannkraft.
Überprüfen Sie den Rundlauf der Werkzeuge. Sie sollten darauf achten, dass der Rundlauffehler nicht größer als 0.01 mm ist.

Sollten Sie aufgrund der Machinendrehzahl nicht in der Lage sein, die angegebenen Drehzahlen ein zuhalten, achten Sie darauf, dass Sie die Vf entsprechend anpassen. $V_f = f_z * n * z$ (n: aktuelle Machinendrehzahl).

B

Solid Carbide end mills
Vollhartmetallschaftfräser

Recommended cutting data · Empfohlene Schnittdaten

HM-2B | HM-2BL | HM-2BFP

Workpiece material Werkstückstoff	Pre-hardened steel, Hardened steel Vergüteter Stahl, Gehärteter Stahl 40~50HRC				Hardened steel Gehärteter Stahl 50~60HRC				Hardened steel Gehärteter Stahl 60~68HRC			
	Rotating Drehzahl (min ⁻¹)	Feed Vorschub (mm/min)	Ap (mm)	Ae (mm)	Rotating Drehzahl (min ⁻¹)	Feed Vorschub (mm/min)	Ap (mm)	Ae (mm)	Rotating Drehzahl (min ⁻¹)	Feed Vorschub (mm/min)	Ap (mm)	Ae (mm)
R0.5	40000	1900	0.01	0.05	36000	1500	0.01	0.05	32000	1400	0.01	0.05
R1.0	33000	3100	0.02	0.075	26000	2100	0.02	0.075	24000	2000	0.02	0.075
R1.5	29000	4100	0.03	0.1	23000	2900	0.03	0.1	21000	2600	0.03	0.1
R2.0	22000	3900	0.04	0.15	17000	2500	0.04	0.15	15500	2100	0.04	0.15
R2.5	17500	3500	0.05	0.15	13500	2200	0.05	0.15	13000	2000	0.05	0.15
R3.0	15000	3100	0.06	0.2	11500	1700	0.06	0.2	10500	1500	0.06	0.2
R4.0	11000	2500	0.08	0.25	8600	1600	0.08	0.25	8000	1400	0.08	0.25
R5.0	9000	2000	0.1	0.3	7000	1400	0.1	0.3	6000	1200	0.1	0.3
R6.0	7500	1800	0.1	0.35	5700	1300	0.1	0.35	5300	1200	0.1	0.35
R8.0	5500	1800	0.1	0.4	4300	1300	0.1	0.4	4000	1200	0.1	0.4
R10.0	4500	1800	0.1	0.5	3500	1300	0.1	0.5	3200	1200	0.1	0.5

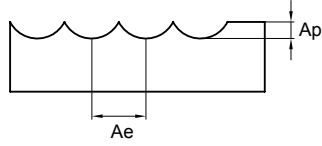
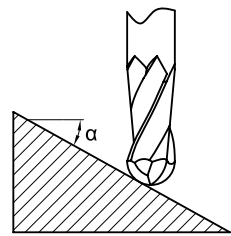
Max. cutting depth max Schnitttiefe		
--	---	--

1. Please select machine and holder with high precision and rigidity.
2. Above table shows the standard for operations with a low change of machining load, such as Contour machining. Vibration and unusual noise may be generated if the machine rigidity and workpiece fixture stability is low, please reduce the rotating speed and feed stated above correspondingly.
3. Please use air blow or MQL (minimum oil mist cooling).
4. When inclination angle α is more than 15° , please reduce rotating speed and feed to 50%~80% of the above conditions.
5. Make overhang as short as possible if no interference.

1. Bitte präzise Maschine und Werkzeugaufnahmen wählen.
2. Schnittdatenempfehlung der obigen Tabelle sind für das Profilfräsen ausgelegt (leicht reduziert). Bei Vibrationen oder unüblichen Geräuschen reduzieren Sie die Schnittdaten entsprechend.
3. Bitte Luftkühlung oder MQL (Minimalmenge) benutzen.
4. Wenn der Neigungswinkel α mehr als 15° beträgt, bitte die Schnittgeschwindigkeit und den Vorschub auf 50-80% der obigen Schnittdaten reduzieren.
5. Empfohlene Fräsmethode: Gleichlaufräsen.

Milling · Fräsen

Solid Carbide end mills · Vollhartmetallschaftfräser

HM-2BS series for machining high hardness steel · **HM-2BS** Serie für die Hartbearbeitung

2-flute tiny diameter ball nose end mills with straight shank
2-Schneiden Mirco-Kugelpkopfräser mit Zylinderschaft

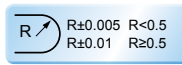
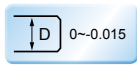
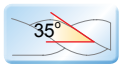
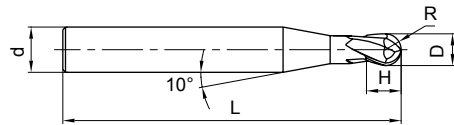

Type Typ	Dimension(mm) Abmessungen					Teeth Zähne Z	Grade Sorte KMG 555
	D	R	d	H	L		
HM-2BS-R0.15	0.30	0.15	4.0	0.5	50	2	●
HM-2BS-R0.20	0.40	0.20	4.0	0.6	50	2	●
HM-2BS-R0.25	0.50	0.25	4.0	0.8	50	2	●
HM-2BS-R0.30	0.60	0.30	4.0	0.9	50	2	●
HM-2BS-R0.35	0.70	0.35	4.0	1.0	50	2	●
HM-2BS-R0.40	0.80	0.40	4.0	1.2	50	2	●
HM-2BS-R0.45	0.90	0.45	4.0	1.3	50	2	●
HM-2BS-R0.50	1.00	0.50	4.0	1.5	50	2	●
HM-2BS-R0.60	1.20	0.60	4.0	1.8	50	2	●
HM-2BS-R0.70	1.40	0.70	4.0	2.0	50	2	●
HM-2BS-R0.75	1.50	0.75	4.0	2.3	50	2	●
HM-2BS-R0.80	1.60	0.80	4.0	2.5	50	2	●
HM-2BS-R0.90	1.80	0.90	4.0	2.7	50	2	●
HM-2BS-R1.00	2.00	1.00	4.0	3.0	50	2	●
HM-2BS-R1.25	2.50	1.25	4.0	3.7	50	2	●
HM-2BS-R1.50	3.00	1.50	4.0	4.5	50	2	●

B

Solid Carbide end mills
Vollhartmetallschaftfräser

Material Overview · Material Übersicht

✓ = Very suitable · Sehr empfohlen
✓ = Suitable · Empfohlen

KMG555

Workpiece material Werkstückstoff											
Carbon steel Kohlenstoff Stahl	Alloy steel Legierter Stahl	Quenched and tempered steel · Vergüteter Stahl		Hardened steel · Gehärteter Stahl		Stainless steel · Rostfreier Stahl	Cast iron, Nodular cast iron Grauguss GGG	Copper alloy Kupfer Leg	Aluminum alloy Alu Leg	Titanium alloy Titan Leg	Heat resist alloy warmfeste Leg
		~40HRC	~50HRC	~60HRC	~68HRC						
			✓	✓	✓		✓				

● Ex Stock / ab Lager ○ On demand / auf Anfrage

HM-2BP series for machining high hardness steel · **HM-2BP** Serie für die Hartbearbeitung

2-flute short cutting edge ball nose micro end mills with straight shank and long neck
2-Schneiden Micro Kugelkopffräser mit kurzer Schneide und Zylinderschaft

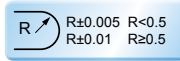
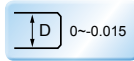
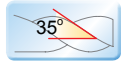
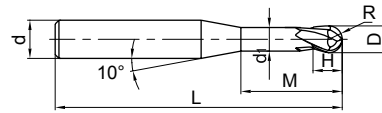

Type Typ	Dimension(mm) Abmessungen							Teeth Zähne Z	Grade Sorte KMG 555
	D	R	H	d ₁	M	d	L		
HM-2BP-R0.25-M04	0.5	0.25	0.7	0.45	4.0	4.0	50	2	●
HM-2BP-R0.25-M06	0.5	0.25	0.7	0.45	6.0	4.0	50	2	●
HM-2BP-R0.3-M04	0.6	0.3	0.9	0.55	4.0	4.0	50	2	●
HM-2BP-R0.3-M06	0.6	0.3	0.9	0.55	6.0	4.0	50	2	●
HM-2BP-R0.3-M08	0.6	0.3	0.9	0.55	8.0	4.0	50	2	●
HM-2BP-R0.4-M04	0.8	0.4	1.2	0.75	4.0	4.0	50	2	●
HM-2BP-R0.4-M06	0.8	0.4	1.2	0.75	6.0	4.0	50	2	●
HM-2BP-R0.4-M08	0.8	0.4	1.2	0.75	8.0	4.0	50	2	●
HM-2BP-R0.4-M10	0.8	0.4	1.2	0.75	10.0	4.0	50	2	●
HM-2BP-R0.5-M04	1.0	0.5	1.5	0.95	4.0	4.0	50	2	●
HM-2BP-R0.5-M06	1.0	0.5	1.5	0.95	6.0	4.0	50	2	●
HM-2BP-R0.5-M08	1.0	0.5	1.5	0.95	8.0	4.0	50	2	●
HM-2BP-R0.5-M10	1.0	0.5	1.5	0.95	10.0	4.0	50	2	●
HM-2BP-R0.5-M12	1.0	0.5	1.5	0.95	12.0	4.0	50	2	●
HM-2BP-R0.6-M06	1.2	0.6	1.8	1.15	6.0	4.0	50	2	●
HM-2BP-R0.6-M08	1.2	0.6	1.8	1.15	8.0	4.0	50	2	●
HM-2BP-R0.6-M12	1.2	0.6	1.8	1.15	12.0	4.0	50	2	●
HM-2BP-R0.6-M16	1.2	0.6	1.8	1.15	16.0	4.0	50	2	●
HM-2BP-R0.75-M08	1.5	0.75	2.3	1.45	8.0	4.0	50	2	●
HM-2BP-R0.75-M12	1.5	0.75	2.3	1.45	12.0	4.0	50	2	●
HM-2BP-R0.75-M16	1.5	0.75	2.3	1.45	16.0	4.0	50	2	●
HM-2BP-R1.0-M06	2.0	1.0	3.0	1.95	6.0	4.0	50	2	●
HM-2BP-R1.0-M08	2.0	1.0	3.0	1.95	8.0	4.0	50	2	●
HM-2BP-R1.0-M10	2.0	1.0	3.0	1.95	10.0	4.0	50	2	●
HM-2BP-R1.0-M12	2.0	1.0	3.0	1.95	12.0	4.0	50	2	●
HM-2BP-R1.0-M16	2.0	1.0	3.0	1.95	16.0	4.0	50	2	●
HM-2BP-R1.0-M20	2.0	1.0	3.0	1.95	20.0	4.0	50	2	●
HM-2BP-R1.25-M08	2.5	1.25	3.7	2.4	8.0	4.0	50	2	●
HM-2BP-R1.25-M12	2.5	1.25	3.7	2.4	12.0	4.0	50	2	●
HM-2BP-R1.25-M16	2.5	1.25	3.7	2.4	16.0	4.0	60	2	●
HM-2BP-R1.25-M20	2.5	1.25	3.7	2.4	20.0	4.0	60	2	●

Material Overview · Material Übersicht

✓ = Very suitable · Sehr empfohlen
 ✓ = Suitable · Empfohlen

KMG555

Workpiece material Werkstückstoff											
Carbon steel Kohlenstoff Stahl	Alloy steel Legierter Stahl	Quenched and tempered steel · Vergüteter Stahl		Hardened steel · Gehärteter Stahl		Stainless steel · Rostfreier Stahl	Cast iron, Nodular cast iron Grauguss GGG	Copper alloy Kupfer Leg	Aluminum alloy Alu Leg	Titanium alloy Titan Leg	Heat resist alloy warmfeste Leg
		~40HRC	~50HRC	~60HRC	~68HRC						
			✓	✓	✓		✓				

Code key **B252,B254**
ISO Kennzeichen

Cutting data **B435-B437**
Schnittdaten

Graphics identification & application **B253,B255**
Graphische Werkzeug- & Anwendungsbeschr.

Order form for non-standard products **B534-B535**
Bestellformular für Sonderwerkzeuge

Milling · Fräsen

Solid Carbide end mills · Vollhartmetallschaftfräser

HM-2BP series for machining high hardness steel · **HM-2BP** Serie für die Hartbearbeitung

2-flute short cutting edge ball nose micro end mills with straight shank and long neck
2-Schneiden Micro Kugelkopffräser mit kurzer Schneide und Zylinderschaft

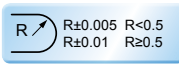
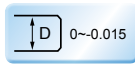
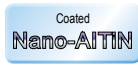
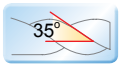
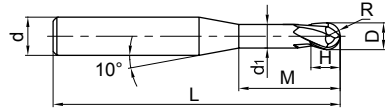

Type Typ	Dimension(mm) Abmessungen							Teeth Zähne Z	Grade Sorte KMG 555
	D	R	H	d1	M	d	L		
HM-2BP-R1.5-M08	3.0	1.5	4.5	2.85	8.0	6.0	50	2	●
HM-2BP-R1.5-M10	3.0	1.5	4.5	2.85	10.0	6.0	50	2	●
HM-2BP-R1.5-M12	3.0	1.5	4.5	2.85	12.0	6.0	50	2	●
HM-2BP-R1.5-M16	3.0	1.5	4.5	2.85	16.0	6.0	60	2	●
HM-2BP-R1.5-M20	3.0	1.5	4.5	2.85	20.0	6.0	60	2	●
HM-2BP-R2.0-M10	4.0	2.0	6.0	3.85	10.0	6.0	60	2	●
HM-2BP-R2.0-M16	4.0	2.0	6.0	3.85	16.0	6.0	60	2	●
HM-2BP-R2.0-M20	4.0	2.0	6.0	3.85	20.0	6.0	60	2	●
HM-2BP-R2.0-M25	4.0	2.0	6.0	3.85	25.0	6.0	60	2	●
HM-2BP-R2.5-M16	5.0	2.5	7.5	4.85	16.0	6.0	60	2	●
HM-2BP-R2.5-M25	5.0	2.5	7.5	4.85	25.0	6.0	70	2	●

Tool type / Werkzeug: HM-2BP-R0.3-M08
 Size / Größe: R 0.3mm
 Workpiece material
 Werkstückstoff: S136/52HRC
 Rotating speed / Drehzahl: 30000 r/min
 Feed / Vorschub: 200 mm/min
 Axial cutting depth /
 Axiale Zustellung: Ap=0.02mm
 Radial cutting depth /
 Radiale Zustellung: Ae=0.04mm
 Cutting style /
 Bearbeitung: contour machining (mould of car light)
 Cooling syste: air blow
 Machine /
 Maschine: MIKRON HSM 800

End mill Schafffräser	HM-2BP-R0.3-M08	Similar product of company A
Cutting time Standzeit	300 min	180 min
Wear value Verschleiß	0.025 mm	0.048 mm

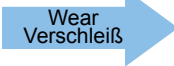

Material Overview · Material Übersicht

✓ = Very suitable · Sehr empfohlen
 ✓ = Suitable · Empfohlen

Workpiece material Werkstückstoff											
Carbon steel Kohlenstoff Stahl	Alloy steel Legierter Stahl	Quenched and tempered steel · Vergüteter Stahl		Hardened steel · Gehärteter Stahl		Stainless steel · Rostfreier Stahl	Cast iron, Nodular cast iron Grauguss GGG	Copper alloy Kupfer Leg	Aluminum alloy Alu Leg	Titanium alloy Titan Leg	Heat resist alloy warmfeste Leg
		~40HRC	~50HRC	~60HRC	~68HRC						
			✓	✓	✓		✓				

● Ex Stock / ab Lager ○ On demand / auf Anfrage

B

Solid Carbide end mills
Vollhartmetallschaftfräser

KMG555

Recommended cutting data · Empfohlene Schnittdaten

HM-2BS

Workpiece material Werkstückmaterial	Pre-hardened steel, Hardened steel Vergüteter Stahl, Gehärteter Stahl 40~50HRC		Hardened steel Gehärteter Stahl 50~60HRC		
	Diameter Ø Durchmesser (mm)	Rotating Drehzahl (min ⁻¹)	Feed Vorschub (mm/min)	Rotating Drehzahl (min ⁻¹)	Feed Vorschub (mm/min)
R0.15		25000	135	25000	115
R0.2		25000	140	25000	120
R0.25		25000	150	25000	130
R0.3		25000	175	24000	150
R0.35		25000	190	24000	150
R0.4		24000	210	18000	140
R0.45		21000	210	15000	140
R0.5		19000	210	14000	140
R1.0		9500	210	7200	140
R1.5		6400	210	4800	140

Max. cutting depth max Schnitttiefe	
--	--

1. Please select high precise machine and tool holder.
2. Please use air blow or cutting liquid with high mist retardant property.
3. Make overhang as short as possible if no interference.
4. Reduce Feed correspondingly when rotating speed is low.

1. Bitte präzise Maschine und Werkzeugaufnahmen wählen
2. Bitte Luftkühlung oder MQL (Minimalmengen) benutzen.
3. Werkzeugauskragung so kurz wie möglich wählen.
4. Bitte Vorschub entsprechend reduzieren, wenn die Drehzahlen niedrig sind.

B

Solid Carbide end mills
Vollhartmetallschaftfräser

Milling - Fräsen

Solid Carbide end mills - Vollhartmetallschaftfräser

Recommended cutting data - Empfohlene Schnittdaten

HM-2BP

Workpiece material Werkstückstoff		Pre-hardened steel, Hardened steel Vergüteter Stahl, Gehärteter Stahl 40~50HRC				Hardened steel Gehärteter Stahl 50~60HRC			
Diameter Ø Durchmesser (mm)	Effective length Effektive Länge (mm)	Rotating Drehzahl (min ⁻¹)	Feed Vorschub (mm/min)	Ap (mm)	Ae (mm)	Rotating Drehzahl (min ⁻¹)	Feed Vorschub (mm/min)	Ap (mm)	Ae (mm)
R0.25	4	27000	200	0.01	0.01	27000	100	0.01	0.01
	6	20000	150	0.005	0.01	20000	75	0.005	0.005
R0.3	4	24000	200	0.03	0.06	17000	150	0.02	0.04
	6	20000	150	0.02	0.03	17000	150	0.01	0.02
	8	20000	120	0.02	0.03	17000	120	0.01	0.02
R0.4	4	21000	300	0.04	0.08	14500	200	0.03	0.08
	6	19000	200	0.02	0.04	12000	150	0.02	0.04
	8	17000	150	0.02	0.04	12000	100	0.02	0.04
	10	17000	135	0.02	0.03	12000	75	0.01	0.02
R0.5	4	21000	300	0.05	0.10	14500	200	0.05	0.10
	6	16000	200	0.05	0.10	11500	150	0.05	0.10
	8	16000	180	0.03	0.05	11500	135	0.03	0.05
	10	14000	150	0.01	0.03	9800	100	0.01	0.03
	12	14000	135	0.01	0.03	9800	75	0.01	0.03
R0.6	6	14000	200	0.06	0.12	9500	175	0.06	0.12
	8	14000	180	0.06	0.12	9500	150	0.06	0.12
	12	11000	150	0.04	0.06	7500	100	0.03	0.06
	16	11000	135	0.02	0.04	7500	75	0.02	0.03
R0.75	8	12000	250	0.08	0.15	8000	200	0.08	0.15
	12	12000	225	0.06	0.15	8000	175	0.06	0.15
	16	9500	150	0.01	0.05	6500	100	0.01	0.03
R1.0	6	13500	400	0.10	0.20	7500	225	0.10	0.20
	8	13500	400	0.10	0.16	7500	225	0.10	0.16
	10	10000	275	0.08	0.16	5500	175	0.08	0.16
	12	10000	275	0.06	0.16	5500	175	0.06	0.16
	16	10000	250	0.02	0.10	5500	150	0.02	0.10
	20	8000	175	0.02	0.05	5500	125	0.01	0.05

Max. cutting depth
max Schnitttiefe

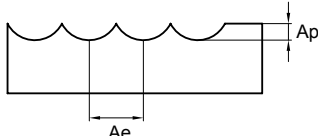

B

Solid Carbide end mills
Vollhartmetallschaftfräser

Recommended cutting data · Empfohlene Schnittdaten

HM-2BP

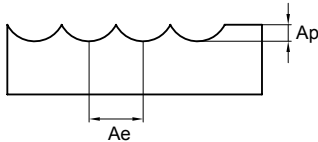
Workpiece material Werkstückstoff		Pre-hardened steel, Hardened steel Vergüteter Stahl, Gehärteter Stahl 40~50HRC				Hardened steel Gehärteter Stahl 50~60HRC			
Diameter Ø Durchmesser (mm)	Effective length Effektive Länge (mm)	Rotating Drehzahl (min ⁻¹)	Feed Vorschub (mm/min)	Ap (mm)	Ae (mm)	Rotating Drehzahl (min ⁻¹)	Feed Vorschub (mm/min)	Ap (mm)	Ae (mm)
R1.25	8	12500	400	0.10	0.16	7000	225	0.10	0.16
	12	9000	275	0.06	0.16	5000	175	0.06	0.16
	16	9000	250	0.02	0.10	5000	150	0.02	0.10
	20	5500	175	0.02	0.05	5000	125	0.01	0.05
R1.5	8	7500	400	0.15	0.30	4000	200	0.15	0.30
	10	7500	400	0.10	0.30	4000	200	0.10	0.30
	12	7500	360	0.10	0.30	4000	180	0.10	0.30
	16	6500	250	0.05	0.20	3000	150	0.05	0.20
	20	6500	250	0.02	0.10	3000	150	0.02	0.05
R2.0	10	6000	400	0.20	0.40	3000	200	0.20	0.40
	16	6000	400	0.10	0.32	3000	200	0.20	0.20
	20	5000	250	0.10	0.20	2500	100	0.10	0.20
	25	5000	250	0.10	0.20	2500	100	0.10	0.10
R2.5	16	5000	400	0.25	0.50	3000	200	0.2	0.2
	25	4000	250	0.25	0.50	3000	100	0.20	0.2
Max. cutting depth max Schnitttiefe									

1. Please select high precise machine and tool holder.
2. Please use air blow or cutting liquid with high mist retardant property.
3. Make overhang as short as possible if no interference.
4. Reduce Feed correspondingly when rotating speed is low.

1. Bitte präzise Maschine und Werkzeugaufnahmen wählen
2. Bitte Luftkühlung oder MQL (Minimalmengen) benutzen.
3. Werkzeugauskragung so kurz wie möglich wählen.
4. Bitte Vorschub entsprechend reduzieren, wenn die Drehzahlen niedrig sind.

Milling · Fräsen

Solid Carbide end mills · Vollhartmetallschaftfräser

ZCC CT 4-flute ball nose end mills for HSC machining high hardness steel (HRC>48) short

ZCC CT 4-Schneiden VHM Kugelkopffräser für Hartbearbeitung im HSC Bereich (HRC>48) kurz

5566R304HH

KMG405: nano AlTiN Coated Ultra-fine carbide / nano AlTiN beschichtetes Ultrafeinkornhartmetall

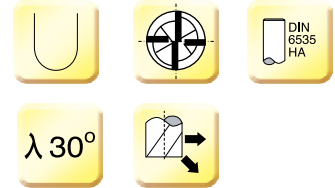
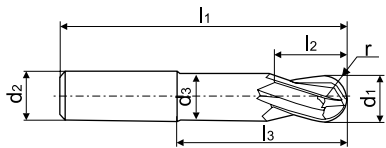

Type Typ	Dimension(mm) Abmessungen							Teeth Zähne	Application Anwendung	P K H
	d1	d2(h6)	l2	l1	d3	l3	r(fs)			
5566R304HH-0600	6.00	6	7	80	5.50	20	3.00	4		○
5566R304HH-0800	8.00	8	9	90	7.40	26	4.00	4		○
5566R304HH-1000	10.00	10	11	100	9.20	31	5.00	4		○
5566R304HH-1200	12.00	12	12	120	11.00	37	6.00	4		○

Art. Group No. / Produktgruppe Nr. : 024130

Material Overview · Material Übersicht

✓ = Very suitable · Sehr empfohlen
 ✓ = Suitable · Empfohlen

KMG555

Workpiece material Werkstückstoff										
Carbon steel Kohlenstoff Stahl	Alloy steel Legierter Stahl	Quenched and tempered steel · Vergüteter Stahl		Hardened steel · Gehärteter Stahl	Stainless steel · Rostfreier Stahl	Cast iron, Nodular cast iron Grauguss GGG	Copper alloy Kupfer Leg	Aluminum alloy Alu Leg	Titanium alloy Titan Leg	Heat resist alloy warmfeste Leg
		~40HRC	~50HRC							
			✓			✓				

● Ex Stock / ab Lager ○ On demand / auf Anfrage

HM-4B series for machining high hardness steel · **HM-4B** Serie für die Hartbearbeitung

4-flute ball nose mills with long straight shank
4-Schneiden Kugelkopffräser mit Zylinderschaft

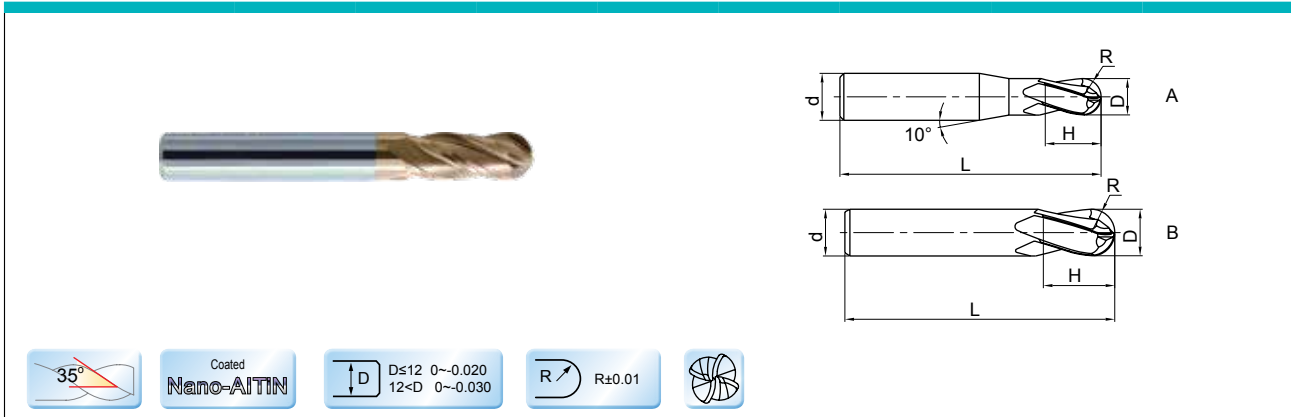

Type Typ	Dimension(mm) Abmessungen					Teeth Zähne Z	Geometry Ausführung	Grade Sorte KMG 555
	D	R	d	H	L			
HM-4B-R1.5	3.0	1.5	6.0	6.0	50	4	A	●
HM-4B-R2.0	4.0	2.0	6.0	8.0	50	4	A	●
HM-4B-R2.5	5.0	2.5	6.0	10.0	50	4	A	●
HM-4B-R3.0	6.0	3.0	6.0	12.0	50	4	B	●
HM-4B-R4.0	8.0	4.0	8.0	16.0	60	4	B	●
HM-4B-R5.0	10.0	5.0	10.0	20.0	75	4	B	●
HM-4B-R6.0	12.0	6.0	12.0	24.0	75	4	B	●
HM-4B-R7.0	14.0	7.0	14.0	28.0	75	4	B	●
HM-4B-R8.0	16.0	8.0	16.0	32.0	100	4	B	●
HM-4B-R9.0	18.0	9.0	18.0	36.0	100	4	B	●
HM-4B-R10.0	20.0	10.0	20.0	40.0	100	4	B	●

B

Solid Carbide end mills
Vollhartmetallschaftfräser

Material Overview · Material Übersicht

✓ = Very suitable · Sehr empfohlen
 ✓ = Suitable · Empfohlen

KMG555

Workpiece material Werkstückstoff											
Carbon steel Kohlenstoff Stahl	Alloy steel Legierter Stahl	Quenched and tempered steel · Vergüteter Stahl		Hardened steel · Gehärteter Stahl		Stainless steel · Rostfreier Stahl	Cast iron, Nodular cast iron Grauguss GGG	Copper alloy Kupfer Leg	Aluminum alloy Alu Leg	Titanium alloy Titan Leg	Heat resist alloy warmfeste Leg
		~40HRC	~50HRC	~60HRC	~68HRC						
			✓	✓	✓		✓				

Code key **B252,B254**
ISO Kennzeichen

Cutting data **B441-B442**
Schnittdaten

Graphics identification & application **B253,B255**
Graphische Werkzeug- & Anwendungsbeschr.

Order form for non-standard products **B534-B535**
Bestellformular für Sonderwerkzeuge

Milling · Fräsen

Solid Carbide end mills · Vollhartmetallschaftfräser

HM-4BL

4-flute ball nose mills with long straight shank and long cutting edge
4-Schneiden Kugelkopffräser mit mit langer Schneide und Zylinderschaft

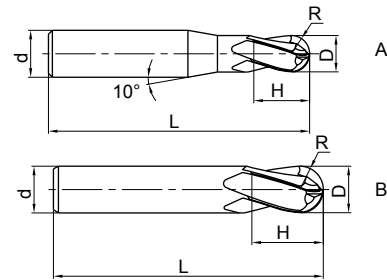

Type Typ	Dimension(mm) Abmessungen					Teeth Zähne Z	Type Typ	Grade Sorte KMG 555
	D	R	d	H	L			
HM-4BL-R1.5	3.0	1.5	6	6	75	4	A	●
HM-4BL-R2.0	4.0	2.0	6	8	75	4	A	●
HM-4BL-R2.5	5.0	2.5	6	10	75	4	A	●
HM-4BL-R3.0	6.0	3.0	6	12	75	4	B	●
HM-4BL-R4.0	8.0	4.0	8	16	100	4	B	●
HM-4BL-R5.0	10.0	5.0	10	20	100	4	B	●
HM-4BL-R6.0	12.0	6.0	12	24	100	4	B	●
HM-4BL-R7.0	14.0	7.0	14	28	100	4	B	●
HM-4BL-R8.0	16.0	8.0	16	32	150	4	B	●
HM-4BL-R9.0	18.0	9.0	18	36	150	4	B	●
HM-4BL-R10.0	20.0	10.0	20	40	150	4	B	●

Material Overview · Material Übersicht



✓ = Very suitable · Sehr empfohlen
✓ = Suitable · Empfohlen

KMG555

Workpiece material Werkstückstoff											
Carbon steel Kohlenstoff Stahl	Alloy steel Legierter Stahl	Quenched and tempered steel · Vergüteter Stahl		Hardened steel · Gehärteter Stahl		Stainless steel · Rostfreier Stahl	Cast iron, Nodular cast iron Grauguss GGG	Copper alloy Kupfer Leg	Aluminum alloy Alu Leg	Titanium alloy Titan Leg	Heat resist alloy warmfeste Leg
		~40HRC	~50HRC	~60HRC	~68HRC						
			✓	✓	✓		✓				

● Ex Stock / ab Lager ○ On demand / auf Anfrage

Recommended cutting data · Empfohlene Schnittdaten

Type Typ	Grade Sorte	Material Werkstoffe	d ₁ (mm)	z	V _c (m/min)	f _z (mm/z)	a _p (mm)	a _e (mm)	d _{eff} (mm)	n (min ⁻¹)	V _f (mm/min)	
5566R304HH  	KMG405	P Steel, steel alloy Stahl, legierter Stahl HRC=42-48	6.00	4	430	0.090	0.18	0.09	4.59			
			8.00	4	430	0.120	0.24	0.12	6.12			
			10.00	4	430	0.150	0.30	0.15	7.65			
			12.00	4	430	0.120	0.72	0.12	10.22			
		K Cast iron Guss	6.00	4	550	0.090	0.18	0.09	4.59			
			8.00	4	550	0.120	0.24	0.12	6.12			
			10.00	4	550	0.150	0.30	0.15	7.65			
		H Steel, steel alloy Stahl, legierter Stahl HRC=48-54	6.00	4	350	0.090	0.18	0.09	4.59			
			8.00	4	350	0.120	0.24	0.12	6.12			
			10.00	4	350	0.150	0.30	0.15	7.65			
			12.00	4	350	0.120	0.72	0.12	10.22			
			Hard steel Gehärteter Stahl HRC > 60	6.00	4	100	0.090	0.18	0.09	4.59		
				8.00	4	100	0.120	0.24	0.12	6.12		
				10.00	4	100	0.150	0.30	0.15	7.65		
		12.00		4	100	0.120	0.72	0.12	10.22			

- Please start a test cutting with 85% of the V_c or 75% of the f_z, then increase the cutting speed and feed rate.
- Please use high precision and high rigidity clamping system. The oscillation of the tool can not be over 0.01 mm.

$$N = 1000V_c / d_{eff} / 3.14159$$

When the rotating speed of the machine on site cannot reach the maximum rotation speed of the machine used for the calculation of the rotating speed: $V_f = f_z * n * z$ (n: actual rotation of the machine).

- Bitte führen Sie einen Testschnitt mit 85% der V_c und 75% des f_z durch.
Nach erfolgreichem Test können Sie die Schnittgeschwindigkeit bzw. die Vorschubwerte entsprechend erhöhen.
- Bitte verwenden Sie nur Spannmittel mit einer hohen Genauigkeit und einer hohen Spannkraft.
Überprüfen Sie den Rundlauf der Werkzeuge. Sie sollten darauf achten, dass der Rundlauffehler nicht größer als 0.01 mm ist.

Sollten Sie aufgrund der Machinendrehzahl nicht in der Lage sein, die angegebenen Drehzahlen ein zuhalten, achten Sie darauf, dass Sie die V_f entsprechend anpassen. $V_f = f_z * n * z$ (n: aktuelle Machinendrehzahl).

B

Solid Carbide end mills
Vollhartmetallschaftfräser

Milling · Fräsen

Solid Carbide end mills · Vollhartmetallschaftfräser

Recommended cutting data · Empfohlene Schnittdaten

HM-4B | HM-4BL

Workpiece material Werkstückstoff	Pre-hardened steel, Hardened steel Vergüteter Stahl, Gehärteter Stahl 40~50HRC				Hardened steel Gehärteter Stahl 50~60HRC				Hardened steel Gehärteter Stahl 60~68HRC			
	Rotating Drehzahl (min^{-1})	Feed Vorschub (mm/min)	A_p (mm)	A_e (mm)	Rotating Drehzahl (min^{-1})	Feed Vorschub (mm/min)	A_p (mm)	A_e (mm)	Rotating Drehzahl (min^{-1})	Feed Vorschub (mm/min)	A_p (mm)	A_e (mm)
R1.5	29000	6560	0.03	0.1	22800	4560	0.03	0.1	21100	4240	0.03	0.1
R2.0	22000	6250	0.04	0.15	17100	4000	0.04	0.15	15800	3520	0.04	0.15
R2.5	17400	5600	0.05	0.15	13600	3520	0.05	0.15	12700	3200	0.05	0.15
R3.0	14500	5000	0.06	0.2	11400	3000	0.06	0.2	10600	2500	0.06	0.2
R4.0	10900	4200	0.08	0.25	8550	2500	0.08	0.25	7950	2250	0.08	0.25
R5.0	8700	3500	0.1	0.3	6850	2200	0.1	0.3	6350	2000	0.1	0.3
R6.0	7250	3000	0.1	0.35	5700	2000	0.1	0.35	5300	1900	0.1	0.35
R8.0	5450	3000	0.1	0.4	4280	2000	0.1	0.4	4000	1900	0.1	0.4
R10.0	4350	3000	0.1	0.5	3425	2000	0.1	0.5	3200	1900	0.1	0.5

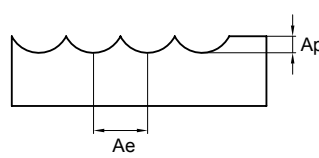
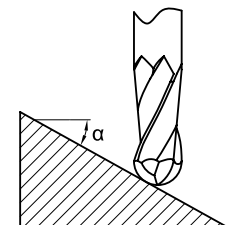
Max. cutting depth max Schnitttiefe		
--	--	--

1. Please select machine and holder with high precision and rigidity.
2. Above table shows the standard for operations with a low change of machining load, such as Contour machining. Vibration and unusual noise may be generated if the machine rigidity and workpiece fixture stability is low, please reduce the rotating speed and feed stated above correspondingly.
3. Please use air blow or MQL (minimum oil mist cooling).
4. When inclination angle α is more than 15° , please reduce rotating speed and feed to 50%~80% of the above conditions.
5. Make overhang as short as possible if no interference.

1. Bitte präzise Maschinen und Werkzeughalter verwenden.
2. Schnittdatenempfehlung der obigen Tabelle sind für das Profilfräsen ausgelegt (leicht reduziert). Bei Vibrationen oder unüblichen Geräuschen reduzieren Sie die Schnittdaten entsprechend.
3. Bitte Luftkühlung oder MQL (Minimalmengen) benutzen
4. Wenn der Neigungswinkel α mehr als 15° beträgt, bitte die Schnittgeschwindigkeit und den Vorschub auf 50-80% der obigen Schnittdaten reduzieren.
5. Werkzeugauskragung so kurz wie möglich wählen.

● Ex Stock / ab Lager ○ On demand / auf Anfrage

ZCC CT 4-flute radius end mills for machining of steel (HRC>48)

ZCC CT 4-Schneiden VHM Schaftfräser mit Eckenradius für die Stahlbearbeitung (HRC>48)

5585R554HHR

KMG405: nano AlTiN Coated Ultra-fine carbide /
nano AlTiN beschichtetes Ultrafeinkornhartmetall

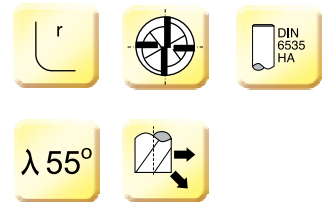
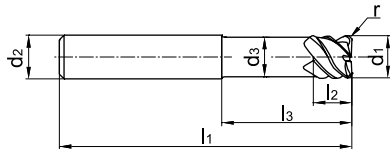
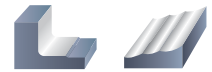

Type Typ	Dimension(mm) Abmessungen							Teeth Zähne	Application Anwendung	Grade Sorte	P K H
	d1(e8)	d2(h6)	l2	l1	d3	l3	r(+0.03)				
5585R554HHR03-0600	6.00	6	7	57	5.50	20	0.3	4		KMG405	●
5585R554HHR15-0600	6.00	6	7	57	5.50	20	1.5	4		KMG405	●
5585R554HHR03-0800	8.00	8	9	63	7.40	26	0.3	4		KMG405	●
5585R554HHR20-0800	8.00	8	9	63	7.40	26	2.0	4		KMG405	●
5585R554HHR05-1000	10.00	10	11	72	9.20	31	0.5	4		KMG405	●
5585R554HHR25-1000	10.00	10	11	72	9.20	31	2.5	4		KMG405	●
5585R554HHR05-1200	12.00	12	12	83	11.00	37	0.5	4		KMG405	●
5585R554HHR30-1200	12.00	12	12	83	11.00	37	3.0	4		KMG405	●
5585R554HHR10-1600	16.00	16	16	92	15.00	43	1.0	4		KMG405	●
5585R554HHR40-1600	16.00	16	16	92	15.00	43	4.0	4		KMG405	●

Art. Group No. / Produktgruppe Nr. :

024130

B

Solid Carbide end mills
Vollhartmetallschaftfräser

Material Overview · Material Übersicht

✓ = Very suitable · Sehr empfohlen
✓ = Suitable · Empfohlen

Carbon steel Kohlenstoff Stahl	Alloy steel Legierter Stahl	Quenched and tempered steel · Vergüteter Stahl		Hardened steel · Gehärteter Stahl	Stainless steel · Rostfreier Stahl	Cast iron, Nodular cast iron Grauguss GGG	Copper alloy Kupfer Leg	Aluminum alloy Alu Leg	Titanium alloy Titan Leg	Heat resist alloy warmfeste Leg
		~40HRC	~50HRC							
		✓	✓			✓				

KMG405

Code key **B252,B254**
ISO Kennzeichen

Cutting data **B448-B450**
Schnittdaten

Graphics identification & application **B253,B255**
Graphische Werkzeug- & Anwendungsbeschr.

Order form for non-standard products **B534-B535**
Bestellformular für Sonderwerkzeuge

B443

Milling · Fräsen

Solid Carbide end mills · Vollhartmetallschaftfräser

ZCC CT 4-flute ball nose end mills machining high hardness steel (HRC>48)

ZCC CT 4-Schneiden VHM Schaftfräser für Hartbearbeitung (HRC>48)

5586R554HHR

KMG405: nano AlTiN Coated Ultra-fine carbide /
nano AlTiN beschichtetes Ultrafeinkornhartmetall

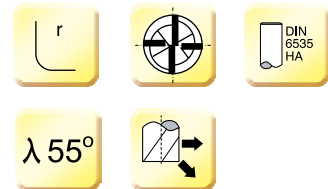
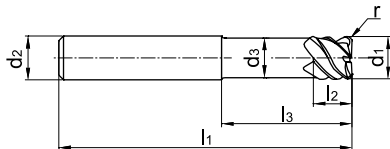
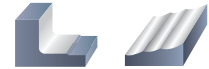

B

Solid Carbide end mills
Vollhartmetallschaftfräser

Type Typ	Dimension(mm) Abmessungen							Teeth Zähne	Application Anwendung	P H	
	d1(e8)	d2(h6)	l2	l1	d3	l3	r(+0.03)			Grade Sorte	KMG405
5586R554HHR03-0600	6.00	6	7	80	5.50	43	0.3	4		●	
5586R554HHR15-0600	6.00	6	7	80	5.50	43	1.5	4		●	
5586R554HHR03-0800	8.00	8	9	90	7.40	53	0.3	4		●	
5586R554HHR20-0800	8.00	8	9	90	7.40	53	2.0	4		●	
5586R554HHR05-1000	10.00	10	11	100	9.20	59	0.5	4		●	
5586R554HHR25-1000	10.00	10	11	100	9.20	59	2.5	4		●	
5586R554HHR05-1200	12.00	12	12	120	11.00	74	0.5	4		●	
5586R554HHR30-1200	12.00	12	12	120	11.00	74	3.0	4		●	
5586R554HHR10-1600	16.00	16	16	140	15.00	91	1.0	4		●	
5586R554HHR40-1600	16.00	16	16	140	15.00	91	4.0	4		●	

Art. Group No. / Produktgruppe Nr. :

024130

Material Overview · Material Übersicht

✓ = Very suitable · Sehr empfohlen
✓ = Suitable · Empfohlen

KMG405

Workpiece material Werkstückstoff										
Carbon steel Kohlenstoff Stahl	Alloy steel Legierter Stahl	Quenched and tempered steel · Vergüteter Stahl		Hardened steel · Gehärteter Stahl	Stainless steel · Rostfreier Stahl	Cast iron, Nodular cast iron Grauguss GGG	Copper alloy Kupfer Leg	Aluminum alloy Alu Leg	Titanium alloy Titan Leg	Heat resist alloy warmfeste Leg
		~40HRC	~50HRC							
		✓	✓			✓				

● Ex Stock / ab Lager ○ On demand / auf Anfrage

HM-4R series for machining high hardness steel · **HM-4R**

Serie für die Hartbearbeitung

4-flute radius end mills with straight shank
4-Schneiden Radiuseckfräser mit Zylinderschaft

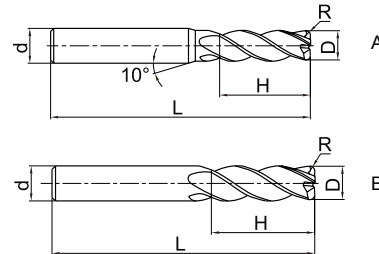
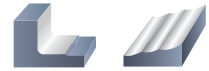

Type Typ	Dimension(mm) Abmessungen					Teeth Zähne Z	Geometry Ausführung	Grade Sorte KMG 555
	D	R	d	H	L			
HM-4R-D3.0R0.2	3.0	0.2	4	8	50	4	A	●
HM-4R-D4.0R0.3	4.0	0.3	4	10	50	4	B	●
HM-4R-D4.0R0.5	4.0	0.5	4	10	50	4	B	●
HM-4R-D5.0R0.5	5.0	0.5	6	13	50	4	A	●
HM-4R-D5.0R1.0	5.0	1.0	6	13	50	4	A	●
HM-4R-D6.0R0.5	6.0	0.5	6	16	50	4	B	●
HM-4R-D6.0R1.0	6.0	1.0	6	16	50	4	B	●
HM-4R-D8.0R0.5	8.0	0.5	8	20	60	4	B	●
HM-4R-D8.0R1.0	8.0	1.0	8	20	60	4	B	●
HM-4R-D10.0R0.5	10.0	0.5	10	25	75	4	B	●
HM-4R-D10.0R1.0	10.0	1.0	10	25	75	4	B	●
HM-4R-D10.0R2.0	10.0	2.0	10	25	75	4	B	●
HM-4R-D10.0R3.0	10.0	3.0	10	25	75	4	B	●
HM-4R-D12.0R0.5	12.0	0.5	12	30	75	4	B	●
HM-4R-D12.0R1.0	12.0	1.0	12	30	75	4	B	●
HM-4R-D12.0R2.0	12.0	2.0	12	30	75	4	B	●
HM-4R-D12.0R3.0	12.0	3.0	12	30	75	4	B	●

B

Solid Carbide end mills
Vollhartmetallschaftfräser

Material Overview · Material Übersicht

✓ = Very suitable · Sehr empfohlen
✓ = Suitable · Empfohlen

KMG555

Workpiece material Werkstückstoff											
Carbon steel Kohlenstoff Stahl	Alloy steel Legierter Stahl	Quenched and tempered steel · Vergüteter Stahl		Hardened steel · Gehärteter Stahl		Stainless steel · Rostfreier Stahl	Cast iron, Nodular cast iron Grauguss GGG	Copper alloy Kupfer Leg	Aluminum alloy Alu Leg	Titanium alloy Titan Leg	Heat resist alloy warmfeste Leg
		~40HRC	~50HRC	~60HRC	~68HRC						
			✓	✓	✓		✓				

Code key **B252,B254**
ISO Kennzeichen

Cutting data **B448-B450**
Schnittdaten

Graphics identification & application **B253,B255**
Graphische Werkzeug- & Anwendungsbeschr.

Order form for non-standard products **B534-B535**
Bestellformular für Sonderwerkzeuge

B445

Milling · Fräsen

Solid Carbide end mills · Vollhartmetallschaftfräser

HM-4RF series for machining high hardness steel · **HM-4RF** Serie für die Hartbearbeitung

4-flute short cutting edge R end mills with straight shank
4-Schneiden Radiuseckfräser mit kurzer Schneide und Zylinderschaft

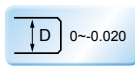
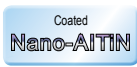
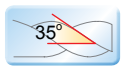
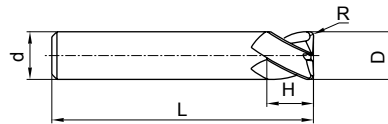
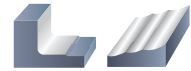

Type Typ	Dimension(mm) Abmessungen					Teeth Zähne Z	Grade Sorte KMG 555
	D	R	d	H	L		
HM-4RF-D6.0R0.5	6.0	0.5	6.0	6	50	4	●
HM-4RF-D6.0R1.0	6.0	1.0	6.0	6	50	4	○
HM-4RF-D8.0R0.5	8.0	0.5	8.0	8	60	4	●
HM-4RF-D8.0R1.0	8.0	1.0	8.0	8	60	4	○
HM-4RF-10.0R0.5	10.0	0.5	10.0	10	75	4	●
HM-4RF-D10.0R1.0	10.0	1.0	10.0	10	75	4	●
HM-4RF-D10.0R2.0	10.0	2.0	10.0	10	75	4	○
HM-4RF-D12.0R0.5	12.0	0.5	12.0	12	75	4	●
HM-4RF-D12.0R1.0	12.0	1.0	12.0	12	75	4	○
HM-4RF-D12.0R2.0	12.0	2.0	12.0	12	75	4	○

Material Overview · Material Übersicht

✓ = Very suitable · Sehr empfohlen
✓ = Suitable · Empfohlen

Workpiece material Werkstückstoff											
Carbon steel Kohlenstoff Stahl	Alloy steel Legierter Stahl	Quenched and tempered steel · Vergüteter Stahl		Hardened steel · Gehärteter Stahl		Stainless steel · Rostfreier Stahl	Cast iron, Nodular cast iron Grauguss GGG	Copper alloy Kupfer Leg	Aluminum alloy Alu Leg	Titanium alloy Titan Leg	Heat resist alloy warmfeste Leg
		~40HRC	~50HRC	~60HRC	~68HRC						
			✓	✓	✓		✓				

● Ex Stock / ab Lager ○ On demand / auf Anfrage

KMG555

HM-4RP series for machining high hardness steel · **HM-4RP** Serie für die Hartbearbeitung

4-flute short cutting edge R end mills with straight shank and long neck
4-Schneiden Radiuseckfräser mit kurzer Schneide und Zylinderschaft

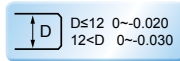
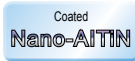
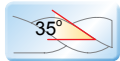
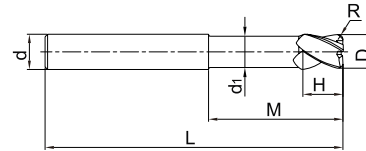
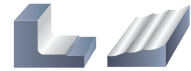

Type Typ	Dimension(mm) Abmessungen							Teeth Zähne Z	Grade Sorte KMG 555
	D	R	d	d ₁	H	M	L		
HM-4RP-D6.0R0.5	6.0	0.5	6.0	5.8	6.0	18	75	4	●
HM-4RP-D6.0R1.0	6.0	1.0	6.0	5.8	6.0	18	75	4	●
HM-4RP-D8.0R0.5	8.0	0.5	8.0	7.8	8.0	24	100	4	●
HM-4RP-D8.0R1.0	8.0	1.0	8.0	7.8	8.0	24	100	4	●
HM-4RP-D10.0R0.5	10.0	0.5	10.0	9.6	10.0	30	100	4	●
HM-4RP-D10.0R1.0	10.0	1.0	10.0	9.6	10.0	30	100	4	●
HM-4RP-D10.0R2.0	10.0	2.0	10.0	9.6	10.0	30	100	4	●
HM-4RP-D12.0R0.5	12.0	0.5	12.0	11.5	12.0	36	100	4	●
HM-4RP-D12.0R1.0	12.0	1.0	12.0	11.5	12.0	36	100	4	●
HM-4RP-D12.0R2.0	12.0	2.0	12.0	11.5	12.0	36	100	4	●
HM-4RP-D16.0R1.0	16.0	1.0	16.0	15.5	16.0	40	150	4	●
HM-4RP-D16.0R2.0	16.0	2.0	16.0	15.5	16.0	40	150	4	●

B

Solid Carbide end mills
Vollhartmetallschaftfräser

Material Overview · Material Übersicht

✓ = Very suitable · Sehr empfohlen
 ✓ = Suitable · Empfohlen

KMG555

Workpiece material Werkstückstoff											
Carbon steel Kohlenstoff Stahl	Alloy steel Legierter Stahl	Quenched and tempered steel · Vergüteter Stahl		Hardened steel · Gehärteter Stahl		Stainless steel · Rostfreier Stahl	Cast iron, Nodular cast iron Grauguss GGG	Copper alloy Kupfer Leg	Aluminum alloy Alu Leg	Titanium alloy Titan Leg	Heat resist alloy warmfeste Leg
		~40HRC	~50HRC	~60HRC	~68HRC						
			✓	✓	✓		✓				

Code key **B252,B254**
ISO Kennzeichen

Cutting data **B448-B450**
Schnittdaten



Graphics identification & application **B253,B255**
Graphische Werkzeug- & Anwendungsbeschr.

Order form for non-standard products **B534-B535**
Bestellformular für Sonderwerkzeuge

Milling - Fräsen

Solid Carbide end mills - Vollhartmetallschaftfräser

Recommended cutting data - Empfohlene Schnittdaten

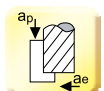
Type Typ	Grade Sorte	Material Werkstoffe	d ₁ (mm)	z	r (mm)	V _c (m/min)	f _z (mm/z)	a _p (mm)	a _e (mm)	n (min ⁻¹)	V _f (mm/min)	
5585R554HHR   	KMG405	P Steel, steel alloy Stahl, legierter Stahl HRC=40-48	6	4	1.5	150	0.120	0.30	1.5	7950	3816	
			8	4	2.0	150	0.150	0.40	4.0	5960	3576	
			10	4	2.5	150	0.140	0.50	5.0	4770	2671	
			12	4	3.0	150	0.170	0.60	6.0	3970	2700	
			16	4	4.0	150	0.210	0.80	8.0	2980	2503	
		H	Hard steel Gehärteter Stahl HRC=50-54	6	4	1.5	120	0.120	0.30	1.5	6360	3053
				8	4	2.0	120	0.150	0.40	4.0	4770	2862
				10	4	2.5	120	0.140	0.50	5.0	3810	2134
				12	4	3.0	120	0.170	0.60	6.0	3180	2162
				16	4	4.0	120	0.210	0.80	8.0	2380	1999
			Hard steel Gehärteter Stahl HRC > 60	6	4	1.5	50	0.12	0.3	0.6	2653	1273
				8	4	2.0	50	0.15	0.4	0.8	1989	1194
				10	4	2.5	50	0.14	0.5	1.0	1592	891
				12	4	3.0	50	0.17	0.6	1.2	1326	902
				16	4	4.0	50	0.21	0.8	1.6	995	836
		P	Hard steel Gehärteter Stahl HRC=40-48	6	4	0.3	100	0.055	6	1.2	5305	1167
				8	4	0.3	100	0.075	8	1.6	3979	1194
				10	4	0.5	100	0.090	10	2.0	3183	1146
				12	4	0.5	100	0.110	12	2.4	2653	1167
				16	4	1.0	100	0.145	16	3.2	1989	1154
H	Hard steel Gehärteter Stahl HRC=50-54		6	4	0.3	50	0.055	6	1.2	2653	584	
			8	4	0.3	50	0.075	8	1.6	1989	597	
			10	4	0.5	50	0.090	10	2.0	1592	573	
			12	4	0.5	50	0.110	12	2.4	1326	584	
			16	4	1.0	50	0.145	16	3.2	995	577	



- Please start a test cutting with 85% of the V_c or 75% of the f_z, then increase the cutting speed and feed rate.
- Please use high precision and high rigidity clamping system. The oscillation of the tool can not be over 0.01 mm.

When the rotating speed of the machine on site cannot reach the maximum rotation speed of the machine used for the calculation of the rotating speed: $V_f = f_z * n * z$ (n: actual rotation of the machine).

- Bitte führen Sie einen Testschnitt mit 85% der V_c und 75% des f_z durch.
Nach erfolgtem Test können Sie die Schnittgeschwindigkeit bzw. die Vorschubwerte entsprechend erhöhen.
- Bitte verwenden Sie nur Spannmittel mit einer hohen Genauigkeit und einer hohen Spannkraft.
Überprüfen Sie den Rundlauf der Werkzeuge. Sie sollten darauf achten, dass der Rundlauffehler nicht größer als 0.01 mm ist.

Sollten Sie aufgrund der Machinendrehzahl nicht in der Lage sein, die angegebenen Drehzahlen ein zuhalten, achten Sie darauf, dass Sie die V_f entsprechend anpassen. $V_f = f_z * n * z$ (n: aktuelle Machinendrehzahl).

Recommended cutting data · Empfohlene Schnittdaten

Type Typ	Grade Sorte	Material Werkstoffe	d ₁ (mm)	z	r (mm)	V _c (m/min)	f _z (mm/z)	a _p (mm)	a _e (mm)	n (min ⁻¹)	V _f (mm/min)		
5586R554HHR  	KMG405	P Steel, steel alloy Stahl, legierter Stahl HRC=40-48	6	4	1.5	120	0.120	0.3	1.5	6366	3056		
			8	4	2.0	120	0.150	0.4	4.0	4775	2865		
			10	4	2.5	120	0.140	0.5	5.0	3820	2139		
			12	4	3.0	120	0.170	0.6	6.0	3183	2165		
			16	4	4.0	120	0.210	0.8	8.0	2387	2005		
		H Hard steel Gehärteter Stahl HRC=50-54	6	4	1.5	100	0.120	0.3	1.5	5305	2546		
			8	4	2.0	100	0.150	0.4	4.0	3979	2387		
			10	4	2.5	100	0.140	0.5	5.0	3183	1783		
			12	4	3.0	100	0.170	0.6	6.0	2653	1804		
			16	4	4.0	100	0.210	0.8	8.0	1989	1671		
		H Hard steel Gehärter Stahl HRC > 60	6	4	1.5	40	0.120	0.3	1.5	2122	1019		
			8	4	2.0	40	0.150	0.4	4.0	1592	955		
			10	4	2.5	40	0.140	0.5	5.0	1273	713		
			12	4	3.0	40	0.170	0.6	6.0	1061	722		
			16	4	4.0	40	0.210	0.8	8.0	796	668		
				P Hard steel Gehärteter Stahl HRC=40-48	6	4	0.3	90	0.055	6	1.2	4775	1050
					8	4	0.3	90	0.075	8	1.6	3581	1074
					10	4	0.5	90	0.090	10	2.0	2865	1031
					12	4	0.5	90	0.110	12	2.4	2387	1050
					16	4	1.0	90	0.145	16	3.2	1790	1038
H Hard steel Gehärteter Stahl HRC=50-54	6			4	0.3	45	0.055	6	1.2	2387	525		
	8			4	0.3	45	0.075	8	1.6	1790	537		
	10			4	0.5	45	0.090	10	2.0	1432	516		
	12			4	0.5	45	0.110	12	2.4	1194	525		
	16			4	1.0	45	0.145	16	3.2	895	519		

- Please start a test cutting with 85% of the V_c or 75% of the f_z, then increase the cutting speed and feed rate.
- Please use high precision and high rigidity clamping system. The oscillation of the tool can not be over 0.01 mm.

When the rotating speed of the machine on site cannot reach the maximum rotation speed of the machine used for the calculation of the rotating speed: $V_f = f_z * n * z$ (n: actual rotation of the machine).

- Bitte führen Sie einen Testschnitt mit 85% der V_c und 75% des f_z durch.
Nach erfolgtem Test können Sie die Schnittgeschwindigkeit bzw. die Vorschubwerte entsprechend erhöhen.
- Bitte verwenden Sie nur Spannmittel mit einer hohen Genauigkeit und einer hohen Spannkraft.
Überprüfen Sie den Rundlauf der Werkzeuge. Sie sollten darauf achten, dass der Rundlauffehler nicht größer als 0.01 mm ist.

Sollten Sie aufgrund der Machinendrehzahl nicht in der Lage sein, die angegebenen Drehzahlen ein zu halten, achten Sie darauf, dass Sie die V_f entsprechend anpassen. $V_f = f_z * n * z$ (n: aktuelle Machinendrehzahl).

Milling - Fräsen

Solid Carbide end mills - Vollhartmetallschaftfräser

Recommended cutting data - Empfohlene Schnittdaten

HM-4R | HM-4RP | HM-4RF

Workpiece material Werkstückstoff	Pre-hardened steel, Hardened steel Vergüteter Stahl, Gehärteter Stahl 40~50HRC		Hardened steel Gehärteter Stahl 50~60HRC		Hardened steel Gehärteter Stahl 60~68HRC	
Cutting speed Schnittgeschw.	300m/min		150m/min		100m/min	
Diameter Ø Durchmesser (mm)	Rotating Drehzahl (min ⁻¹)	Feed Vorschub (mm/min)	Rotating Drehzahl (min ⁻¹)	Feed Vorschub (mm/min)	Rotating Drehzahl (min ⁻¹)	Feed Vorschub (mm/min)
3	32000	1225	16000	610	11000	420
4	24000	1500	12000	745	8000	500
5	19000	1630	9500	815	6400	550
6	16000	1850	8000	925	5300	610
8	12000	1850	6000	925	4000	610
10	9600	1850	4800	925	3200	610
12	8000	1920	4000	960	2700	648
16	6000	1440	3000	720	2000	480

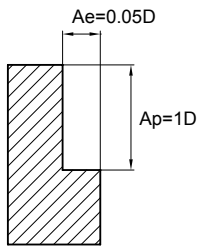
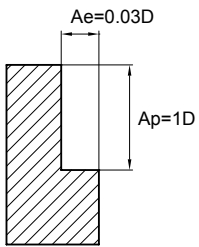
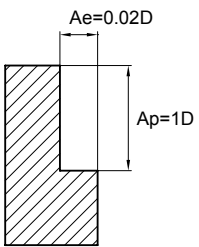
Max. cutting depth max Schnitttiefe	Ae=0.05D  Maximum Ae=1.0mm	Ae=0.03D  Maximum Ae=0.5mm	Ae=0.02D  Maximum Ae=0.3mm
--	--	--	--

1. Please select machine and holder with high precision and rigidity.
2. Vibration and unusual noise may be generated if the machine rigidity and workpiece fixture stability is low, please reduce the rotating speed and feed stated above correspondingly.
3. Please use air blow or MQL (minimum oil mist cooling).
4. Down milling is recommended in side milling.
5. Make overhang as short as possible if no interference.

1. Bitte Maschine und Werkzeugaufnahme mit hoher Präzision und Stabilität wählen.
2. Bei Vibrationen oder unüblichen Geräuschen reduzieren Sie die Schnittdaten entsprechend.
3. Als Kühlmittel bitte Luft oder MQL (Minimalmengen) verwenden.
4. Fräsmethode zum Eckfräsen: Gleichlaufräsen.
5. Die Werkzeugauskragung so kurz wie möglich wählen.

B

Solid Carbide end mills
Vollhartmetallschaftfräser

NM series end mills for machining copper Serie VHM-Fräser für die Kupferbearbeitung

Extremely outstanding NM series end mills, greatly improve the machining performance in copper or copper alloy.

Extrem leistungsstarke NM Schaftfräser, für die wirtschaftliche Bearbeitung von Kupfer und Kupferlegierungen.

- Transcendent sharpness is very suitable for high precision machining copper or copper alloy.
- CrN coating with perfect lubricating property and minimal friction factor, achieves light and fast cutting process, extra long tool life and high surface quality.
- Hervorragende Schneidenschärfe ist besonders geeignet für die Präzisionsbearbeitung von Kupfer oder Kupferlegierungen.
- Bei Einsatz von Kühlmittel erzeugt die CrN-beschichtete Schneidplatte geringste Reibung. Das Ergebnis ist leichte und schnelle Zerspanung bei besonders langer Werkzeugstandzeit und sehr guter Werkstück-Oberflächenqualität.

Coating Beschichtung	Micro hardness (hv) Mikrohärte	Friction factor Bruchfaktor	Initial temperature of oxidation Oxidations temperatur (°C)	Bonding strength with substrate Zähigkeit	
CrN	1800	0.25	700	✓	common excellent ✓
TiN	2200	0.4	500	✓	
TiCN	2700	0.3	400	✓	
TiAlN	2800	0.3	800	✓	

- Tool type / Werkzeug : NM-2B-R3.0
- Size / Größe : R3.0mm
- Workpiece material / Werkstückstoff : C1100
- Rotating speed / Drehzahl : 8000r/min (150m/min)
- Feed / Vorschub : 1200mm/min (0.15mm/r)
- Axial cutting depth / Axiale Zustellung: $A_p=0.3\text{mm}$
- Radial cutting depth / Radiale Zustellung: $A_e=0.6\text{mm}$
- Cutting style / Bearbeitung: face milling / Planfräsen (down milling)
- Cooling system / Kuhlssystem : air blow
- Machine / Maschine: MIKRON UCP 1000

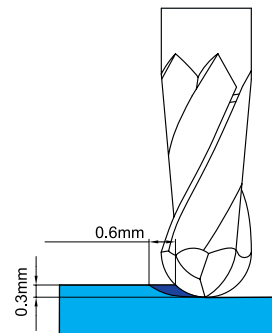

■ Ball nose end mills for machining copper alloy
Kugelkopffräser für Kupferbearbeitung

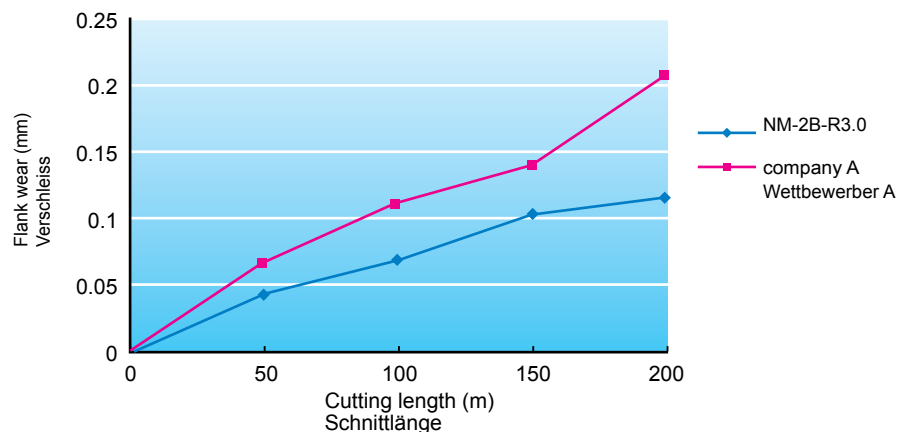

Milling · Fräsen

Solid Carbide end mills · Vollhartmetallschaftfräser

DIN 6527L 2-flute end mills · **DIN 6527L** 2-Schneiden VHM Schaftfräser

5502R402NM

YK30F: Ultrafine carbide / Ultrafeinkornhartmetall

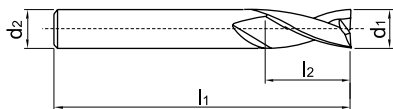
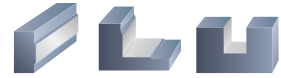

Type Typ	Dimension(mm) Abmessungen				Teeth Zähne	Application Anwendung	N
	d1(e8)	d2(h6)	l2	l1	z	Grade Sorte	YK30F
5502R402NM-0300	3.00	6	8	57	2		●
5502R402NM-0400	4.00	6	11	57	2		●
5502R402NM-0500	5.00	6	13	57	2		●
5502R402NM-0600	6.00	6	13	57	2		●
5502R402NM-0800	8.00	8	19	63	2		●
5502R402NM-1000	10.00	10	22	72	2		●
5502R402NM-1200	12.00	12	26	83	2		●
5502R402NM-1400	14.00	14	26	83	2		●
5502R402NM-1600	16.00	16	32	92	2		●
5502R402NM-1800	18.00	18	32	92	2		●
5502R402NM-2000	20.00	20	38	104	2		●
Art. Group No. / Produktgruppe Nr. :							022140

Material Overview · Material Übersicht

✓ = Very suitable · Sehr empfohlen
 ✓ = Suitable · Empfohlen

YK 30F

Workpiece material Werkstückstoff											
Carbon steel Kohlenstoff Stahl	Alloy steel Legierter Stahl	Quenched and tempered steel · Vergüteter Stahl		Hardened steel · Gehärteter Stahl		Stainless steel · Rostfreier Stahl	Cast iron, Nodular cast iron Grauguss GGG	Copper alloy Kupfer Leg	Aluminum alloy Alu Leg	Titanium alloy Titan Leg	Heat resist alloy warmfeste Leg
		~40HRC	~50HRC	~60HRC	~68HRC						
								✓			

● Ex Stock / ab Lager ○ On demand / auf Anfrage

NM-2E series for machining copper · **NM-2E** Serie für die Bearbeitung von Kupfer

■ **2-flute end mills with straight shank**
2-Schneiden Schaftfräser mit Zylinderschaft

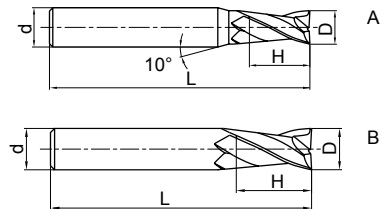

Type Typ	Dimension (mm) Abmessungen				Teeth Zähne Z	Geometry Ausführung	Grade Sorte KMG309
	D	d	H	L			
NM-2E-D1.0	1.0	4	3	50	2	A	●
NM-2E-D2.0	2.0	4	6	50	2	A	●
NM-2E-D3.0	3.0	6	8	50	2	A	●
NM-2E-D4.0	4.0	6	11	50	2	A	●
NM-2E-D5.0	5.0	6	13	50	2	A	●
NM-2E-D6.0	6.0	6	16	50	2	B	●
NM-2E-D8.0	8.0	8	20	60	2	B	●
NM-2E-D10.0	10.0	10	25	75	2	B	●
NM-2E-D12.0	12.0	12	30	75	2	B	●

B

Solid Carbide end mills
 Vollhartmetallschaftfräser

■ **Material Overview · Material Übersicht**

✓ = Very suitable · Sehr empfohlen
 ✓ = Suitable · Empfohlen

KMG309

Workpiece material Werkstückstoff											
Carbon steel Kohlenstoff Stahl	Alloy steel Legierter Stahl	Quenched and tempered steel · Vergüteter Stahl		Hardened steel · Gehärteter Stahl		Stainless steel · Rostfreier Stahl	Cast iron, Nodular cast iron Grauguss GGG	Copper alloy Kupfer Leg	Aluminum alloy Alu Leg	Titanium alloy Titan Leg	Heat resist alloy warmfeste Leg
		~40HRC	~50HRC	~60HRC	~68HRC						
								✓			

Code key **B252, B254**
 ISO Kennzeichen

Cutting data **B454-B455**
 Schnittdaten



Graphics identification & application **B253, B255**
 Graphische Werkzeug- & Anwendungsbeschr.

Order form for non-standard products **B534-B535**
 Bestellformular für Sonderwerkzeuge

Milling - Fräsen

Solid Carbide end mills - Vollhartmetallschaftfräser

Recommended cutting data - Empfohlene Schnittdaten

Type Typ	Grade Sorte	Material Werkstoffe	d ₁ (mm)	z	V _c (m/min)	f _z (mm/z)	a _p (mm)	a _e (mm)	n (min ⁻¹)	V _f (mm/min)	
 	YK30F	N	Al	6.00	2	350	0.080	9	1.50	18560	2970
				8.00	2	350	0.100	12	2.00	13920	2784
				10.00	2	350	0.120	15	2.50	11140	2674
				12.00	2	350	0.140	18	3.00	9280	2598
				16.00	2	350	0.180	24	4.00	6960	2506
				20.00	2	350	0.220	30	5.00	5570	2451
			Forged aluminum alloy <i>Geschmiedete Al-Legierung</i> Cast aluminum alloy <i>Al-Gusslegierung</i> Si<6%	6.00	2	900	0.080	9	1.50	47740	7638
				8.00	2	900	0.100	12	2.00	35800	7160
				10.00	2	900	0.120	15	2.50	28640	6874
				12.00	2	900	0.140	18	3.00	23870	6684
				16.00	2	900	0.180	24	4.00	17900	6444
			Copper <i>Kupfer</i>	6.00	2	550	0.080	9	1.50	29170	4667
				8.00	2	550	0.100	12	2.00	21880	4376
				10.00	2	550	0.120	15	2.50	17500	4200
				12.00	2	550	0.140	18	3.00	14580	4082
				16.00	2	550	0.180	24	4.00	10940	3938
			Plastic <i>Kunststoff</i>	6.00	2	1200	0.080	9	1.50	60000	9600
				8.00	2	1200	0.100	12	2.00	47740	9548
				10.00	2	1200	0.120	15	2.50	38190	9166
				12.00	2	1200	0.140	18	3.00	31830	8912
				16.00	2	1200	0.180	24	4.00	23870	8593
			20.00	2	1200	0.220	30	5.00	19090	8400	

- Please start a test cutting with 85% of the V_c or 75% of the f_z, then increase the cutting speed and feed rate.
- Please use high precision and high rigidity clamping system. The oscillation of the tool can not be over 0.01 mm.

$$N = 1000V_c / d_{eff} / 3.14159$$
 When the rotating speed of the machine on site cannot reach the maximum rotation speed of the machine used for the calculation of the rotating speed: $V_f = f_z * n * z$ (n: actual rotation of the machine).
- When a_p=1*d₁, f_z = 75% as the data in the table.

- Bitte führen Sie einen Testschnitt mit 85% der V_c und 75% des f_z durch.
Nach erfolgtem Test können Sie die Schnittgeschwindigkeit bzw. die Vorschubwerte entsprechend erhöhen.
- Bitte verwenden Sie nur Spannmittel mit einer hohen Genauigkeit und einer hohen Spannkraft.
Überprüfen Sie den Rundlauf der Werkzeuge. Sie sollten darauf achten, dass der Rundlauffehler nicht größer als 0.01 mm ist.

- Sollten Sie aufgrund der Machinendrehzahl nicht in der Lage sein, die angegebenen Drehzahlen ein zuhalten, achten Sie darauf, dass Sie die V_f entsprechend anpassen. $V_f = f_z * n * z$ (n: aktuelle Machinendrehzahl).
- Bei Fräsoperationen, die mit einer a_p=1*d₁ durchgeführt werden, ist f_z um 25% zu reduzieren.

B

Solid Carbide end mills
Vollhartmetallschaftfräser

Recommended cutting data · Empfohlene Schnittdaten

NM-2E

Workpiece material Werkstückmaterial	Copper / Copper alloy Kupfer / Kupferlegierung		
Diameter Ø Durchmesser (mm)	Rotating Drehzahl (min ⁻¹)	Feed Vorschub (mm/min)	
1	40000	1800	
2	30000	2500	
3	20000	2300	
4	15000	2000	
5	12000	1500	
6	10000	1400	
8	8000	1000	
10	6500	900	
12	5500	850	
Max. cutting depth max Schnitttiefe	<p>Maximum Ae=1.0mm</p> <p>Maximum Ap=1.0mm</p>		

1. The above table shows the reference value of side milling. The Feed in slot milling is recommended 70% of reference value stated above.
2. Please select high rigid and precise machine and tool holder. Vibration and unusual noise may be generated if the machine rigidity and workpiece fixture stability is low, please reduce the rotating speed and feed stated above correspondingly.
3. It is possible to increase the rotating speed and Feed correspondingly if the cutting depth is small.
4. Please use water-soluble cutting liquid.
5. Down milling is recommended in side milling.
6. Make overhang as short as possible if no interference.

1. Die obige Tabelle zeigt die Referenz Schnittdaten für das Eckfräsen.
Für das Nutenfräsen die obigen Schnittdaten um 30 % reduzieren.
2. Bitte präzise Maschinen und Werkzeughalter verwenden. Bei Vibrationen oder unüblichen Geräuschen reduzieren Sie die Schnittdaten entsprechend.
3. Schnittdaten bei kleinen Schnitttiefen erhöhen.
4. Bitte wasserlösliche Kühlmittel verwenden.
5. Fräsmethode zum Eckfräsen: Gleichlaufräsen.
6. Die Werkzeugauskragung so kurz wie möglich wählen.

Milling · Fräsen

Solid Carbide end mills · Vollhartmetallschaftfräser

NM-2EP series for machining cooper · **NM-2EP** Serie für die Bearbeitung von Kupfer

2-flute short cutting edge end mills with straight shank with long neck
2-Schneiden Schaftfräser mit Zylinderschaft

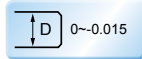
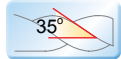
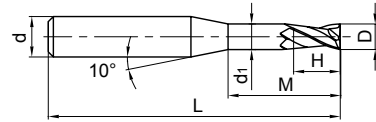

Type Typ	Dimension(mm) Abmessungen						Teeth Zähne Z	Grade Sorte KMG309
	D	d	H	M	d1	L		
NM-2EP-D0.5-M04	0.5	4.0	0.7	4.0	0.45	50	2	●
NM-2EP-D0.5-M06	0.5	4.0	0.7	6.0	0.45	50	2	●
NM-2EP-D0.5-M08	0.5	4.0	0.7	8.0	0.45	50	2	●
NM-2EP-D0.8-M04	0.8	4.0	1.2	4.0	0.75	50	2	●
NM-2EP-D0.8-M06	0.8	4.0	1.2	6.0	0.75	50	2	●
NM-2EP-D0.8-M08	0.8	4.0	1.2	8.0	0.75	50	2	●
NM-2EP-D0.8-M10	0.8	4.0	1.2	10.0	0.75	50	2	●
NM-2EP-D1.0-M04	1.0	4.0	1.5	4.0	0.95	50	2	●
NM-2EP-D1.0-M06	1.0	4.0	1.5	6.0	0.95	50	2	●
NM-2EP-D1.0-M08	1.0	4.0	1.5	8.0	0.95	50	2	●
NM-2EP-D1.0-M10	1.0	4.0	1.5	10.0	0.95	50	2	●
NM-2EP-D1.0-M12	1.0	4.0	1.5	12.0	0.95	50	2	●
NM-2EP-D1.0-M14	1.0	4.0	1.5	14.0	0.95	50	2	●
NM-2EP-D1.5-M08	1.5	4.0	2.3	8.0	1.45	50	2	●
NM-2EP-D1.5-M16	1.5	4.0	2.3	16.0	1.45	50	2	●
NM-2EP-D2.0-M06	2.0	4.0	3.0	6.0	1.95	50	2	●
NM-2EP-D2.0-M08	2.0	4.0	3.0	8.0	1.95	50	2	●
NM-2EP-D2.0-M10	2.0	4.0	3.0	10.0	1.95	50	2	●
NM-2EP-D2.0-M12	2.0	4.0	3.0	12.0	1.95	50	2	●
NM-2EP-D2.0-M14	2.0	4.0	3.0	14.0	1.95	50	2	●
NM-2EP-D2.0-M16	2.0	4.0	3.0	16.0	1.95	50	2	●
NM-2EP-D2.5-M10	2.5	4.0	3.7	10.0	2.4	50	2	●
NM-2EP-D2.5-M20	2.5	4.0	3.7	20.0	2.4	60	2	●
NM-2EP-D3.0-M10	3.0	6.0	4.5	10.0	2.85	50	2	●
NM-2EP-D3.0-M20	3.0	6.0	4.5	20.0	2.85	60	2	●
NM-2EP-D4.0-M16	4.0	6.0	6.0	16.0	3.85	60	2	●
NM-2EP-D4.0-M25	4.0	6.0	6.0	25.0	3.85	60	2	●
NM-2EP-D5.0-M16	5.0	6.0	7.5	16.0	4.85	60	2	●
NM-2EP-D5.0-M25	5.0	6.0	7.5	25.0	4.85	70	2	●

Material Overview · Material Übersicht

✓ = Very suitable · Sehr empfohlen
✓ = Suitable · Empfohlen

KMG309

Workpiece material Werkstückstoff											
Carbon steel Kohlenstoff Stahl	Alloy steel Legierter Stahl	Quenched and tempered steel · Vergüteter Stahl		Hardened steel · Gehärteter Stahl		Stainless steel · Rostfreier Stahl	Cast iron, Nodular cast iron Grauguss GGG	Copper alloy Kupfer Leg	Aluminum alloy Alu Leg	Titanium alloy Titan Leg	Heat resist alloy warmfeste Leg
		~40HRC	~50HRC	~60HRC	~68HRC						
								✓			

● Ex Stock / ab Lager ○ On demand / auf Anfrage

Recommended cutting data · Empfohlene Schnittdaten

NM-2EP

Workpiece material Werkstückstoff		Copper / Copper alloy Kupfer / Kupferlegierung		
Diameter Ø Durchmesser (mm)	Effective length Effektive Länge (mm)	Rotating Drehzahl (min ⁻¹)	Feed Vorschub (mm/min)	Ap (mm)
0.5	4	40000	800	0.004
	6	40000	700	0.002
	8	40000	500	0.001
0.8	4	40000	1000	0.02
	6	40000	1000	0.015
	8	40000	800	0.01
	10	40000	600	0.005
1.0	4	40000	1800	0.04
	6	40000	1500	0.04
	8	40000	1500	0.03
	10	30000	1000	0.02
	12	30000	800	0.015
	14	30000	600	0.01
1.5	8	40000	2000	0.09
	16	20000	1000	0.03
2.0	6	40000	2400	0.18
	8	40000	2200	0.15
	10	40000	2000	0.12
	12	30000	1500	0.10
	14	30000	1200	0.08
	16	30000	1000	0.06
2.5	10	40000	2500	0.15
	20	20000	1000	0.08
3.0	10	20000	2500	0.20
	20	20000	2000	0.12
4.0	16	15000	1800	0.25
	25	15000	1200	0.15
5.0	16	12000	2000	0.40
	25	12000	1500	0.35

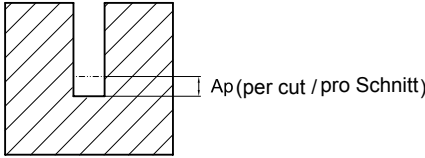
Max. cutting depth max Schnitttiefe	
--	--

1. Please select high precise machine and tool holder.
2. Please use water-soluble cutting liquid.
3. Make overhang as short as possible if no interference.

1. Bitte Maschine und Werkzeugaufnahme mit hoher Präzision und Stabilität wählen.
2. Bitte wasserlösliche Kühlmittel verwenden.
3. Die Werkzeugauskrantung so kurz wie möglich wählen.

Milling · Fräsen

Solid Carbide end mills · Vollhartmetallschaftfräser

NM-4E series for machining cooper · **NM-4E** Serie für die Bearbeitung von Kupfer

4-flute end mills with straight shank
4-Schneiden Schafffräser mit Zylinderschaft

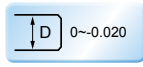
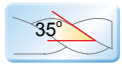
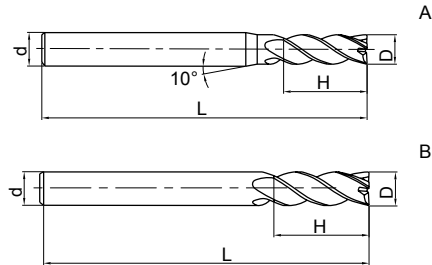

Type Typ	Dimension(mm) Abmessungen				Teeth Zähne Z	Geometry Ausführung	Grade Sorte KMG309
	D	d	H	L			
NM-4E-D3.0	3.0	6	8	50	4	A	●
NM-4E-D4.0	4.0	6	11	50	4	A	●
NM-4E-D5.0	5.0	6	13	50	4	A	●
NM-4E-D6.0	6.0	6	16	50	4	B	●
NM-4E-D8.0	8.0	8	20	60	4	B	●
NM-4E-D10.0	10.0	10	25	75	4	B	●
NM-4E-D12.0	12.0	12	30	75	4	B	●

B

Solid Carbide end mills
Vollhartmetallschaftfräser

Material Overview · Material Übersicht

✓ = Very suitable · Sehr empfohlen
✓ = Suitable · Empfohlen

KMG309

Workpiece material Werkstückstoff											
Carbon steel Kohlenstoff Stahl	Alloy steel Legierter Stahl	Quenched and tempered steel · Vergüteter Stahl		Hardened steel · Gehärteter Stahl		Stainless steel · Rostfreier Stahl	Cast iron, Nodular cast iron Grauguss GGG	Copper alloy Kupfer Leg	Aluminum alloy Alu Leg	Titanium alloy Titan Leg	Heat resist alloy warmfeste Leg
		~40HRC	~50HRC	~60HRC	~68HRC						
								✓			

● Ex Stock / ab Lager ○ On demand / auf Anfrage

Recommended cutting data · Empfohlene Schnittdaten

NM-4E

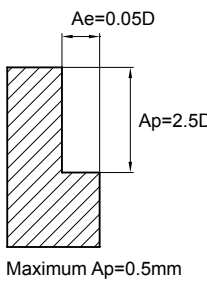
Workpiece material Werkstückmaterial	Copper / Copper alloy Kupfer / Kupferlegierung		
Diameter Ø Durchmesser (mm)	Rotating Drehzahl (min ⁻¹)	Feed Vorschub (mm/min)	
3	10600	250	
4	8000	300	
5	6500	400	
6	5300	400	
8	4000	450	
10	3500	450	
12	3000	450	
Max. cutting depth max Schnitttiefe	 <p>The diagram illustrates the maximum cutting parameters for the end mill. It shows a cross-section of the tool cutting into a workpiece. The axial cutting depth is labeled as $A_e = 0.05D$, where D is the diameter. The radial cutting depth is labeled as $A_p = 2.5D$. A note below the diagram states 'Maximum $A_p = 0.5\text{mm}$'.</p>		

1. Please select high rigid and precise machine and tool holder. Vibration and unusual noise may be generated if the machine rigidity and workpiece fixture stability is low, please reduce the rotating speed and feed stated above correspondingly.
2. It is possible to increase the rotating speed and feed correspondingly if the cutting depth is small.
3. Please use water-soluble cutting liquid.
4. Down milling is recommended in side milling.
5. Make overhang as short as possible if no interference.

1. Bitte Maschine und Werkzeugaufnahme mit hoher Präzision und Stabilität wählen. Bei Vibrationen oder unüblichen Geräuschen reduzieren Sie die Schnittdaten entsprechend.
2. Schnittdaten bei kleinen Schnitttiefen erhöhen.
3. Bitte wasserlösliche Kühlmittel verwenden.
4. Fräsmethode zum Eckfräsen: Gleichlaufräsen.
5. Die Werkzeugauskrantung so kurz wie möglich wählen.

Milling · Fräsen

Solid Carbide end mills · Vollhartmetallschaftfräser

NM-2B series for machining cooper · **NM-2B** Serie für die Bearbeitung von Kupfer

2-flute ball nose mills with straight shank
2-Schneiden Kugelkopffräser mit Zylinderschaft

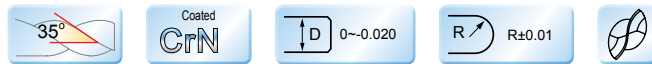
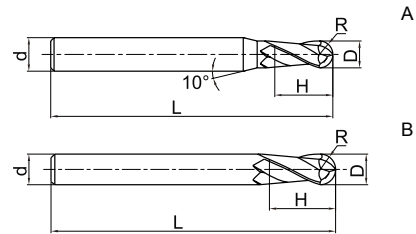

Type Typ	Dimension(mm) Abmessungen					Teeth Zähne Z	Geometry Ausführung	Grade Sorte KMG309
	D	R	d	H	L			
NM-2B-R0.5	1.0	0.5	4.0	2.0	50	2	A	●
NM-2B-R0.75	1.5	0.75	4.0	3.0	50	2	A	●
NM-2B-R1.0	2.0	1.0	4.0	4.0	50	2	A	●
NM-2B-R1.25	2.5	1.25	4.0	5.0	50	2	A	●
NM-2B-R1.5	3.0	1.5	6.0	6.0	50	2	A	●
NM-2B-R1.75	3.5	1.75	6.0	8.0	50	2	A	●
NM-2B-R2.0	4.0	2.0	6.0	8.0	50	2	A	●
NM-2B-R2.5	5.0	2.5	6.0	10.0	50	2	A	●
NM-2B-R3.0	6.0	3.0	6.0	12.0	50	2	B	●
NM-2B-R4.0	8.0	4.0	8.0	16.0	60	2	B	●
NM-2B-R5.0	10.0	5.0	10.0	20.0	75	2	B	●
NM-2B-R6.0	12.0	6.0	12.0	24.0	75	2	B	●

Material Overview · Material Übersicht

✓ = Very suitable · Sehr empfohlen
✓ = Suitable · Empfohlen

KMG309

Workpiece material Werkstückstoff											
Carbon steel Kohlenstoff Stahl	Alloy steel Legierter Stahl	Quenched and tempered steel · Vergüteter Stahl		Hardened steel · Gehärteter Stahl		Stainless steel · Rostfreier Stahl	Cast iron, Nodular cast iron Grauguss GGG	Copper alloy Kupfer Leg	Aluminum alloy Alu Leg	Titanium alloy Titan Leg	Heat resist alloy warmfeste Leg
		~40HRC	~50HRC	~60HRC	~68HRC						
								✓			

● Ex Stock / ab Lager ○ On demand / auf Anfrage

Recommended cutting data · Empfohlene Schnittdaten

NM-2B

Workpiece material Werkstückmaterial	Copper / Copper alloy Kupfer / Kupferlegierung		
Diameter Ø Durchmesser (mm)	Rotating Drehzahl (min ⁻¹)	Feed Vorschub (mm/min)	
R0.5	40000	900	
R0.75	32000	800	
R1.0	24000	870	
R1.25	19000	800	
R1.5	16000	850	
R1.75	14000	850	
R2.0	12000	900	
R2.5	9600	900	
R3.0	8000	1200	
R4.0	7000	1500	
R5.0	4800	1300	
R6.0	4000	1200	
Max. cutting depth max Schnitttiefe	<p>The diagram illustrates the maximum cutting depth parameters for a ball end mill. It shows a cross-section of the tool with a scalloped cutting edge. The axial cutting depth is labeled as $A_e = 0.2R$, and the radial cutting depth is labeled as $A_p = 0.1R$.</p>		

1. Please select high rigid and precise machine and tool holder. Vibration and unusual noise may be generated if the machine rigidity and workpiece fixture stability is low, please reduce the rotating speed and feed stated above correspondingly.
2. It is possible to increase the rotating speed and feed correspondingly if the cutting depth is small.
3. Please use water-soluble cutting liquid.
4. Make overhang as short as possible if no interference.

1. Bitte Maschine und Werkzeugaufnahme mit hoher Präzision und Stabilität wählen. Bei Vibrationen oder unüblichen Geräuschen reduzieren Sie die Schnittdaten (wie oben empfohlen) entsprechend.
2. Schnittdaten bei kleinen Schnitttiefen erhöhen.
3. Bitte wasserlösliche Kühlmittel verwenden.
4. Die Werkzeugauskragung so kurz wie möglich wählen.

Milling · Fräsen

Solid Carbide end mills · Vollhartmetallschaftfräser

NM-2BP series for machining cooper · **NM-2BP** Serie für die Bearbeitung von Kupfer

2-flute short cutting edge ball nose micro end mills with straight shank and long
2-Schneiden Micro Kugelkopffräser, mit kurzer Schneide und Zylinderschaft (lang)

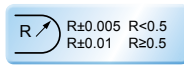
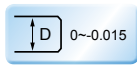
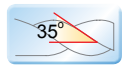
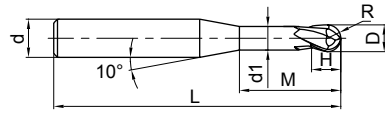

Type Typ	Dimension(mm) Abmessungen							Teeth Zähne Z	Grade Sorte KMG309
	D	R	H	d ₁	M	d	L		
NM-2BP-R0.25-M04	0.5	0.25	0.7	0.45	4.0	4.0	50	2	●
NM-2BP-R0.25-M06	0.5	0.25	0.7	0.45	6.0	4.0	50	2	●
NM-2BP-R0.3-M04	0.6	0.3	0.9	0.55	4.0	4.0	50	2	●
NM-2BP-R0.3-M06	0.6	0.3	0.9	0.55	6.0	4.0	50	2	●
NM-2BP-R0.3-M08	0.6	0.3	0.9	0.55	8.0	4.0	50	2	●
NM-2BP-R0.4-M04	0.8	0.4	1.2	0.75	4.0	4.0	50	2	●
NM-2BP-R0.4-M06	0.8	0.4	1.2	0.75	6.0	4.0	50	2	●
NM-2BP-R0.4-M08	0.8	0.4	1.2	0.75	8.0	4.0	50	2	●
NM-2BP-R0.4-M10	0.8	0.4	1.2	0.75	10.0	4.0	50	2	●
NM-2BP-R0.5-M04	1.0	0.5	1.5	0.95	4.0	4.0	50	2	●
NM-2BP-R0.5-M06	1.0	0.5	1.5	0.95	6.0	4.0	50	2	●
NM-2BP-R0.5-M08	1.0	0.5	1.5	0.95	8.0	4.0	50	2	●
NM-2BP-R0.5-M10	1.0	0.5	1.5	0.95	10.0	4.0	50	2	●
NM-2BP-R0.5-M12	1.0	0.5	1.5	0.95	12.0	4.0	50	2	●
NM-2BP-R0.75-M08	1.5	0.75	2.3	1.45	8.0	4.0	50	2	●
NM-2BP-R0.75-M16	1.5	0.75	2.3	1.45	16.0	4.0	50	2	●
NM-2BP-R1.0-M06	2.0	1.0	3.0	1.95	6.0	4.0	50	2	●
NM-2BP-R1.0-M08	2.0	1.0	3.0	1.95	8.0	4.0	50	2	●
NM-2BP-R1.0-M10	2.0	1.0	3.0	1.95	10.0	4.0	50	2	●
NM-2BP-R1.0-M12	2.0	1.0	3.0	1.95	12.0	4.0	50	2	●
NM-2BP-R1.0-M16	2.0	1.0	3.0	1.95	16.0	4.0	50	2	●
NM-2BP-R1.0-M20	2.0	1.0	3.0	1.95	20.0	4.0	60	2	●
NM-2BP-R1.5-M10	3.0	1.5	4.5	2.85	10.0	6.0	50	2	●
NM-2BP-R1.5-M20	3.0	1.5	4.5	2.85	20.0	6.0	60	2	●
NM-2BP-R2.0-M10	4.0	2.0	6.0	3.85	10.0	6.0	60	2	●
NM-2BP-R2.0-M16	4.0	2.0	6.0	3.85	16.0	6.0	60	2	●
NM-2BP-R2.0-M20	4.0	2.0	6.0	3.85	20.0	6.0	60	2	●
NM-2BP-R2.0-M25	4.0	2.0	6.0	3.85	25.0	6.0	60	2	●
NM-2BP-R2.5-M16	5.0	2.5	7.5	4.85	16.0	6.0	60	2	●
NM-2BP-R2.5-M25	5.0	2.5	7.5	4.85	25.0	6.0	70	2	●

Material Overview · Material Übersicht

✓ = Very suitable · Sehr empfohlen
✓ = Suitable · Empfohlen

KMG309

Workpiece material Werkstückstoff											
Carbon steel Kohlenstoff Stahl	Alloy steel Legierter Stahl	Quenched and tempered steel · Vergüteter Stahl		Hardened steel · Gehärteter Stahl		Stainless steel · Rostfreier Stahl	Cast iron, Nodular cast iron Grauguss GGG	Copper alloy Kupfer Leg	Aluminum alloy Alu Leg	Titanium alloy Titan Leg	Heat resist alloy warmfeste Leg
		~40HRC	~50HRC	~60HRC	~68HRC						
								✓			

● Ex Stock / ab Lager ○ On demand / auf Anfrage

Recommended cutting data · Empfohlene Schnittdaten

NM-2BP

Workpiece material Werkstückstoff		Copper / Copper alloy Kupfer / Kupferlegierung			
Diameter Ø Durchmesser (mm)	Effective length Effektive Länge (mm)	Rotating Drehzahl (min ⁻¹)	Feed Vorschub (mm/min)	Ap (mm)	Ae (mm)
R0.25	4	40000	750	0.01	0.025
	6	36000	500	0.008	0.02
R0.3	4	40000	900	0.012	0.03
	6	40000	750	0.010	0.02
	8	30000	400	0.008	0.01
R0.4	4	40000	1050	0.016	0.04
	6	40000	800	0.012	0.03
	8	40000	500	0.01	0.02
	10	30000	400	0.008	0.01
R0.5	4	40000	1050	0.02	0.05
	6	40000	800	0.016	0.04
	8	40000	500	0.014	0.03
	10	33000	400	0.012	0.02
R0.75	12	35000	300	0.010	0.010
	8	40000	900	0.03	0.075
	16	20000	400	0.015	0.04
R1.0	6	40000	1100	0.04	0.10
	8	40000	900	0.034	0.08
	10	40000	750	0.028	0.065
	12	40000	500	0.022	0.05
	16	30000	400	0.018	0.04
	20	20000	300	0.012	0.03
R1.5	10	40000	1100	0.06	0.15
	20	32000	600	0.03	0.08
R2.0	10	32000	1100	0.08	0.20
	16	32000	900	0.06	0.16
	20	32000	600	0.04	0.12
	25	20000	400	0.02	0.08
R2.5	16	25000	1250	0.10	0.25
	25	20000	900	0.06	0.12

Max. cutting depth
max Schnitttiefe

1. Please select high precise machine and tool holder.
2. Please use water-soluble cutting liquid.
3. Make overhang as short as possible if no interference.

1. Bitte Maschine und Werkzeugaufnahme mit hoher Präzision und Stabilität wählen.
2. Bitte wasserlösliche Kühlmittel verwenden.
3. Die Werkzeugauskragung so kurz wie möglich wählen.

Code key **B252,B254**
ISO Kennzeichen

Cutting data **B463**
Schnittdaten

Graphics identification & application **B253,B255**
Graphische Werkzeug- & Anwendungsbeschr.

Order form for non-standard products **B534-B535**
Bestellformular für Sonderwerkzeuge

AL

series end mills for machining aluminum Serie VHM-Schaftfräser für die Bearbeitung von Aluminium

Complete product category for machining Al alloy from general to ultra high speed.

- Tool type / Werkzeug: AL-3E-D6.0
- Size / Größe: Ø6.0mm
- Workpiece material / Werkstückstoff: LC4
- Rotating speed / Drehzahl: 13000r/min (250m/min)
- Feed / Vorschub: 1950mm/min (0.15mm/r)
- Axial cutting depth / Axiale Zustellung: $A_p=9.0\text{mm}$
- Radial cutting depth / Radiale Zustellung: $A_e=1.0\text{mm}$
- Cutting style / Bearbeitungsart: complicated cavity machining / Kompliziertes Auskammern
- Cooling system / Kühlsystem: air blow
- Machine / Maschine: MIKRON UCP 1000

Komplettes leistungstarkes Programm, für die Bearbeitung von Alu-Legierungen, unter normalen und äußerst hohen Schnittgeschwindigkeiten.

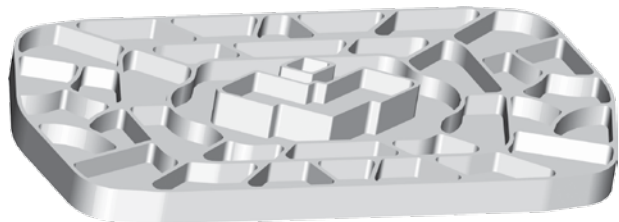

AL-2R, AL-2RL, AL-3R, AL-3RL series are released for ultra high speed milling aerospace Al alloy.

Serie AL-2R, AL-2RL, AL-3R, AL-3RL für die Fräsbearbeitung von Aluminium Legierungen für die Luftfahrt mit "high speed" Schnittgeschwindigkeiten.

Anti-vibration design of whole cutting edge

Antivibrations Schneidengeometrie

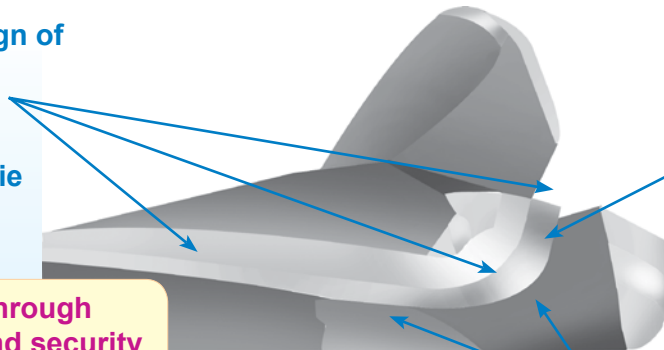

Wiper benefit to improve surface quality

Wiper Geometrie für hohe Oberflächenqualität.

All end mills pass through dynamic balance and security tests.

Alle Fräser sind auf dynamische Balance und Sicherheit getestet worden.

Big chip pocket is suitable for high feed machining

Großer Spanraum für die Spanabfuhr, bei Hochgeschwindigkeitsbearbeitung

AL-3R Hochgeschwindigkeitsbearbeitung

- Tool type / Werkzeug: AL-3R-D20.0R3.0-AIR
- Size / Größe: Ø20.0mm
- Workpiece material / Werkstückm.: A7075
- Cutting speed / Schnittgeschw.: 1500m/min
- Rotating speed / Drehzahl: 25000r/min
- Feed rate per tooth / Vorschub pro Zahn: 0.48mm/r
- Feed / Vorschub: 12000mm/min
- Axial cutting depth / Axiale Zustellung: $A_p=12\text{mm}$
- Radial cutting depth / Radiale Zustellung: $A_e=12\text{mm}$
- Metal removal rate / Zerspanungsvolumen: $1800\text{cm}^3/\text{min}$
- Cutting style / Bearbeitungsart: side milling (down milling)
- Cooling System / Kühlsystem: air blow
- Machine / Maschine: horizontal machining center

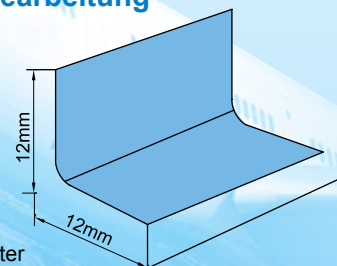

Note: Cutting speed 1500m/min, metal removal rate is $1800\text{cm}^3/\text{min}$
Schnittgeschw. 1500m/min, Zerspanungsvolumen $1800\text{cm}^3/\text{min}$

AL-1E

- 1-flute router with flat end cut with 45° corner chamfer and polished flute (coated)
- 1-Schneider mit flachem Stirnanschliff mit 45° Eckenfase und polierter Nute (mit Beschichtung)

New



with new DLC-Coating
mit neuer DLC Beschichtung

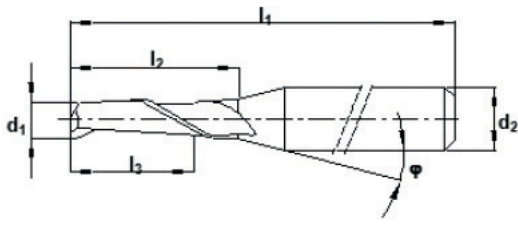







Article no. Artikel Nr.	Dimension (mm) Abmessung								Stock Lager
	d ₁	l ₃	l ₁	l ₂	d ₂	z	a	φ	
598600	2,00	8,00	40,00	10,80	3,000	1	-	18	●
598599	2,00	4,50	50,00	7,30	6,000	1	-	18	●
598663	3,00	8,40	50,00	21,00	6,000	1	0,1	30	●
598662	3,00	12,40	50,00	14,00	6,000	1	-	14	●
598657	4,00	10,40	50,00	21,20	6,000	1	0,1	30	●
598661	4,00	12,40	50,00	16,00	6,000	1	-	11	●
598660	6,00	14,40	50,00	24,00	6,000	1	0,1	-	●
598656	6,00	15,00	50,00	-	6,000	1	-	-	●

Further dimensions available on request
Weitere Abmessungen auf Anfrage lieferbar

AL-1E

- 1-flute router with flat end cut with 45° corner chamfer and polished flute (uncoated)
- 1-Schneider mit flachem Stirnanschliff mit 45° Eckenfase und polierter Nute (ohne Beschichtung)

New



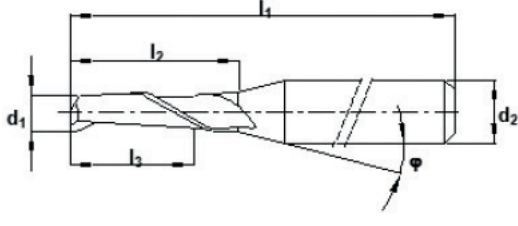

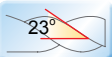





Article no. Artikel Nr.	Dimension (mm) Abmessung								Stock Lager
	d ₁	l ₃	l ₁	l ₂	d ₂	z	a	φ	
598598	2,00	8,00	40,00	10,80	3,000	1	-	18	●
598597	2,00	4,50	50,00	7,30	6,000	1	-	18	●
598667	3,00	8,40	50,00	21,00	6,000	1	0,1	30	●
598666	3,00	12,40	50,00	14,00	6,000	1	-	14	●
598659	4,00	10,40	50,00	21,20	6,000	1	0,1	30	●
598665	4,00	12,40	50,00	16,00	6,000	1	-	11	○
598664	6,00	14,40	50,00	24,00	6,000	1	0,1	-	●
598658	6,00	15,00	50,00	-	6,000	1	-	-	●

Further dimensions available on request
Weitere Abmessungen auf Anfrage lieferbar

● Ex Stock / ab Lager ○ On demand / auf Anfrage

 Code key B252,B254
ISO Kennzeichen

 Cutting data B466
Schnittdaten

 Graphics identification & application B253,B255
Graphische Werkzeug- & Anwendungsbeschr.

 Order form for non-standard products B534-B535
Bestellformular für Sonderwerkzeuge

Milling · Fräsen

Solid Carbide end mills · Vollhartmetallschaftfräser

Al-1E Uncoated Unbeschichtet

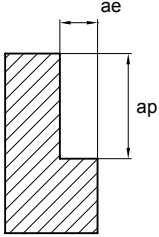
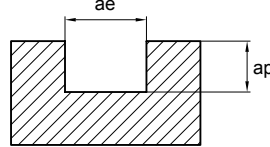
Aluminum alloy <i>Alu-Legierungen</i>						
Uncoated <i>Unbeschichtet</i>			Square sholder milling <i>Schulterfräsen</i>		Slot milling <i>Nutenfräsen</i>	
Diameter Durchmesser Ø (mm)	Rotating Drehzahl (min ⁻¹)	Feed Vorschub (mm/min)	ap [mm]	ae [mm]	ap [mm]	ae [mm]
2	33000	1000	3	0,4	2	2
3	22000	1000	4,5	0,6	3	3
4	16000	800	6	0,8	4	4
6	11000	600	9	1,2	6	1,2
Max. cutting depth max. Schnitttiefe						

Al-1E Coating Beschichtung

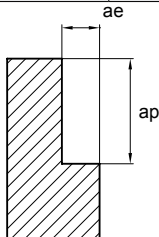
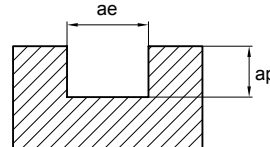
Aluminum alloy <i>Alu-Legierungen</i>						
Coating <i>Beschichtung</i>			Square sholder milling <i>Schulterfräsen</i>		Slot milling <i>Nutenfräsen</i>	
Diameter Durchmesser Ø (mm)	Rotating Drehzahl (min ⁻¹)	Feed Vorschub (mm/min)	ap [mm]	ae [mm]	ap [mm]	ae [mm]
2	40000	1000	3	0,40	2	2,00
3	27000	1000	4,5	0,60	3	3,00
4	20000	800	6	0,80	4	4,00
6	14000	600	9	1,20	6	6,00
Max. cutting depth max. Schnitttiefe						

● Ex Stock / ab Lager ○ On demand / auf Anfrage

AL-2E series for machining aluminium · **AL-2E** Serie für die Bearbeitung von Aluminium

2-flute end mills with straight shank
2-Schneiden Schaftfräser mit Zylinderschaft

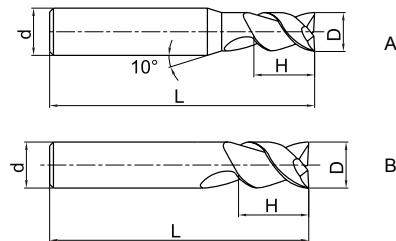

Type Typ	Dimension(mm) Abmessungen				Teeth Zähne Z	Geometry Ausführung	Grade Sorte YK30F
	D	d	H	L			
AL-2E-D1.0	1.0	4	3	50	2	A	●
AL-2E-D1.5	1.5	4	4	50	2	A	●
AL-2E-D2.0	2.0	4	6	50	2	A	●
AL-2E-D2.5	2.5	4	7	50	2	A	●
AL-2E-D3.0	3.0	6	9	50	2	A	●
AL-2E-D4.0	4.0	6	12	50	2	A	●
AL-2E-D5.0	5.0	6	15	50	2	A	●
AL-2E-D6.0	6.0	6	18	60	2	B	●
AL-2E-D8.0	8.0	8	20	60	2	B	●
AL-2E-D10.0	10.0	10	30	75	2	B	●
AL-2E-D12.0	12.0	12	32	75	2	B	●
AL-2E-D16.0	16.0	16	45	100	2	B	●
AL-2E-D20.0	20.0	20	45	100	2	B	●

B

Solid Carbide end mills
Vollhartmetallschaftfräser

Material Overview · Material Übersicht

✓ = Very suitable · Sehr empfohlen
✓ = Suitable · Empfohlen

YK 30F

Workpiece material Werkstückstoff											
Carbon steel Kohlenstoff Stahl	Alloy steel Legierter Stahl	Quenched and tempered steel · Vergüteter Stahl		Hardened steel · Gehärteter Stahl		Stainless steel · Rostfreier Stahl	Cast iron, Nodular cast iron Grauguss GGG	Copper alloy Kupfer Leg	Aluminum alloy Alu Leg	Titanium alloy Titan Leg	Heat resist alloy warmfeste Leg
		~40HRC	~50HRC	~60HRC	~68HRC						
									✓		

Code key **B252,B254**
ISO Kennzeichen

Cutting data **B469**
Schnittdaten

Graphics identification & application **B253,B255**
Graphische Werkzeug- & Anwendungsbeschr.

Order form for non-standard products **B534-B535**
Bestellformular für Sonderwerkzeuge

Milling · Fräsen

Solid Carbide end mills · Vollhartmetallschaftfräser

AL-2EL series for machining aluminium · **AL-2EL** Serie für die Bearbeitung von Aluminium

2-flute long cutting edge end mills with straight shank
2-Schneiden Schafffräser mit langer Schneide und Zylinderschaft

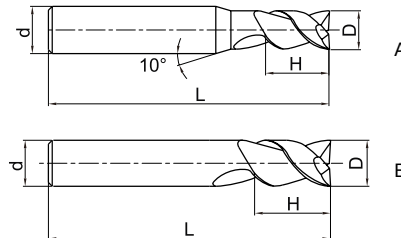

Type Typ	Dimension(mm) Abmessungen				Teeth Zähne Z	Geometry Ausführung	Grade Sorte YK30F
	D	d	H	L			
AL-2EL-D3.0	3.0	6	12	60	2	A	●
AL-2EL-D4.0	4.0	6	16	60	2	A	●
AL-2EL-D5.0	5.0	6	20	60	2	A	●
AL-2EL-D6.0	6.0	6	25	75	2	B	●
AL-2EL-D8.0	8.0	8	32	75	2	B	●
AL-2EL-D10.0	10.0	10	45	100	2	B	●
AL-2EL-D12.0	12.0	12	45	100	2	B	●
AL-2EL-D16.0	16.0	16	65	150	2	B	●
AL-2EL-D20.0	20.0	20	75	150	2	B	●

B

Solid Carbide end mills
Vollhartmetallschaftfräser

Material Overview · Material Übersicht

✓ = Very suitable · Sehr empfohlen
✓ = Suitable · Empfohlen

Workpiece material Werkstückstoff											
Carbon steel Kohlenstoff Stahl	Alloy steel Legierter Stahl	Quenched and tempered steel · Vergüteter Stahl		Hardened steel · Gehärteter Stahl		Stainless steel · Rostfreier Stahl	Cast iron, Nodular cast iron Grauguss GGG	Copper alloy Kupfer Leg	Aluminum alloy Alu Leg	Titanium alloy Titan Leg	Heat resist alloy warmfeste Leg
		~40HRC	~50HRC	~60HRC	~68HRC						
									✓		

● Ex Stock / ab Lager ○ On demand / auf Anfrage

YK 30F

Recommended cutting data · Empfohlene Schnittdaten

AL-2E | AL-2EL

Workpiece material Werkstückmaterial	Aluminum alloy Alu Legierungen		Silicon aluminium alloy Si≤10% Silizium Alu Legierungen Si≤10%		
	Diameter Ø Durchmesser (mm)	Rotating Drehzahl (min ⁻¹)	Feed Vorschub (mm/min)	Rotating Drehzahl (min ⁻¹)	Feed Vorschub (mm/min)
1		40000	650	40000	500
2		40000	950	32000	750
3		26500	1500	21000	1100
4		20000	1600	16000	1250
5		16000	1500	13000	1100
6		13000	1250	10600	1000
8		10000	1400	8000	1100
10		8000	1600	6500	1250
12		6600	1650	5300	1300
14		5700	1700	4600	1350
16		5000	1700	4000	1350
18		4400	1700	3500	1350
20		4000	1700	3200	1350
Max. cutting depth max Schnitttiefe					

1. The above table shows the reference value of side milling. The Feed in slot milling is recommended 70% of reference value stated above.
2. Please select high rigid and precise machine and tool holder. Vibration and unusual noise may be generated if the machine rigidity and workpiece fixture stability is low, please reduce the rotating speed and feed stated above correspondingly.
3. It is possible to increase the rotating speed and feed correspondingly if the cutting depth is small.
4. Please use water-soluble cutting liquid.
5. Down milling is recommended in side milling.
6. Make overhang as short as possible if no interference.

1. Die obige Tabelle zeigt die Referenz Schnittdaten für das Eckfräsen.
Für das Nutenfräsen die obigen Schnittdaten auf 70 % reduzieren.
2. Bitte präzise Maschinen und Werkzeughalter verwenden. Bei Vibrationen oder unüblichen Geräuschen reduzieren Sie die Schnittdaten (wie oben empfohlen) entsprechend.
3. Schnittdaten bei kleinen Schnitttiefen erhöhen.
4. Bitte wasserlösliche Kühlmittel verwenden.
5. Fräsmethode zum Eckfräsen: Gleichlaufräsen.
6. Die Werkzeugauskragung so kurz wie möglich wählen.

Milling · Fräsen

Solid Carbide end mills · Vollhartmetallschaftfräser

ALG-2E

2-flute router with flat end cut (uncoated)

2- Schneider mit flachem Stirnanschliff (ohne Beschichtung)

New

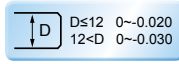
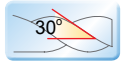
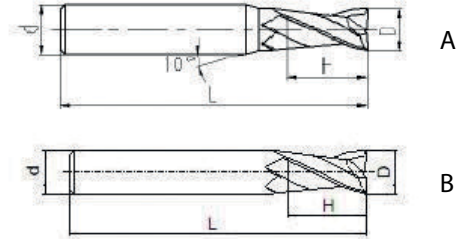

Type · Typ	Dimension (mm) Abmessungen				Teeth · Zähne Z	Geometry Ausführung	YK40F
	D	d	H	L			
ALG-2E-D1.0	1.0	4	3	50	2	A	●
ALG-2E-D1.5	1.5	4	4	50	2	A	●
ALG-2E-D2.0	2.0	4	6	50	2	A	●
ALG-2E-D2.5	2.5	4	8	50	2	A	●
ALG-2E-D3.0S	3.0	4	8	50	2	A	●
ALG-2E-D3.0	3.0	6	8	50	2	A	●
ALG-2E-D3.5S	3.5	4	10	50	2	A	○
ALG-2E-D3.5	3.5	6	10	50	2	A	●
ALG-2E-D4.0S	4.0	4	11	50	2	B	○
ALG-2E-D4.0	4.0	6	11	50	2	A	●
ALG-2E-D4.5	4.5	6	11	50	2	A	○
ALG-2E-D5.0	5.0	6	13	50	2	A	●
ALG-2E-D5.5	5.5	6	16	50	2	A	●
ALG-2E-D6.0	6.0	6	16	50	2	B	●
ALG-2E-D7.0	7.0	8	20	60	2	A	●
ALG-2E-D8.0	8.0	8	20	60	2	B	●
ALG-2E-D9.0	9.0	10	22	75	2	A	●
ALG-2E-D10.0	10.0	10	25	75	2	B	●
ALG-2E-D11.0	11.0	12	26	75	2	A	●
ALG-2E-D12.0	12.0	12	30	75	2	B	●
ALG-2E-D14.0	14.0	14	32	75	2	B	●
ALG-2E-D16.0	16.0	16	45	100	2	B	●
ALG-2E-D18.0	18.0	18	45	100	2	B	●
ALG-2E-D20.0	20.0	20	45	100	2	B	●

Further dimensions available on request
Weitere Abmessungen auf Anfrage lieferbar

● Ex Stock / ab Lager ○ On demand / auf Anfrage

Recommended cutting data · Empfohlene Schnittdaten

ALG-2E

Workpiece material Werkstückstoff	Aluminum alloy Alu-Legierungen		Silicon aluminium alloy Si≤10% Silizium-Alu-Legierungen Si≤10%	
	Diameter Durchmesser Ø (mm)	Rotating Drehzahl (min ⁻¹)	Feed Vorschub (mm/min)	Rotating Drehzahl (min ⁻¹)
1	40000	800	40000	600
2	40000	1200	32000	900
3	26500	1800	21000	1300
4	20000	2000	16000	1500
5	16000	1750	13000	1300
6	13000	1500	10600	1200
8	10000	1650	8000	1300
10	8000	1900	6500	1500
12	6600	1950	5300	1550
14	5700	2000	4600	1600
16	5000	2000	4000	1600
18	4400	2000	3500	1600
20	4000	2000	3200	1600
Max. cutting depth max. Schnitttiefe				

B

Solid Carbide end mills
Vollhartmetallschaftfräser

Milling · Fräsen

Solid Carbide end mills · Vollhartmetallschaftfräser

AL-3E series for machining aluminium · **AL-3E** Serie für die Bearbeitung von Aluminium

3-flute end mills with straight shank
3-Schneiden Schafffräser mit Zylinderschaft

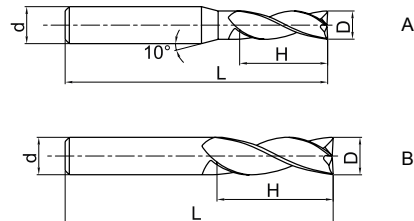
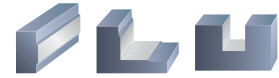

Type Typ	Dimension(mm) Abmessungen				Teeth Zähne Z	Geometry Ausführung	Grade Sorte YK30F
	D	d	H	L			
AL-3E-D1.0	1.0	4	3	50	3	A	●
AL-3E-D1.5	1.5	4	4	50	3	A	●
AL-3E-D2.0	2.0	4	6	50	3	A	●
AL-3E-D2.5	2.5	4	7	50	3	A	●
AL-3E-D3.0	3.0	6	9	50	3	A	●
AL-3E-D4.0	4.0	6	12	50	3	A	●
AL-3E-D5.0	5.0	6	15	50	3	A	●
AL-3E-D6.0	6.0	6	18	60	3	B	●
AL-3E-D8.0	8.0	8	20	60	3	B	●
AL-3E-D10.0	10.0	10	30	75	3	B	●
AL-3E-D12.0	12.0	12	32	75	3	B	●
AL-3E-D16.0	16.0	16	45	100	3	B	●
AL-3E-D20.0	20.0	20	45	100	3	B	●

Material Overview · Material Übersicht

✓ = Very suitable · Sehr empfohlen
✓ = Suitable · Empfohlen

Workpiece material Werkstückstoff											
Carbon steel Kohlenstoff Stahl	Alloy steel Legierter Stahl	Quenched and tempered steel · Vergüteter Stahl		Hardened steel · Gehärteter Stahl		Stainless steel · Rostfreier Stahl	Cast iron, Nodular cast iron Grauguss GGG	Copper alloy Kupfer Leg	Aluminum alloy Alu Leg	Titanium alloy Titan Leg	Heat resist alloy warmfeste Leg
		~40HRC	~50HRC	~60HRC	~68HRC						
									✓		

● Ex Stock / ab Lager ○ On demand / auf Anfrage

B

Solid Carbide end mills
Vollhartmetallschaftfräser

YK 30F

AL-3EL

3-flute end mills with straight shank and long cutting edge
3-Schneiden Schaftfräser mit langer Schneide und Zylinderschaft

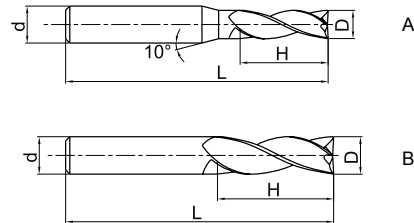

Type Typ	Dimension (mm) Abmessungen				Teeth Zähne Z	Geometry Ausführung	Grade Sorte YK30F
	D	d	H	L			
AL-3EL-D3.0	3.0	6	12	60	3	A	●
AL-3EL-D4.0	4.0	6	16	60	3	A	●
AL-3EL-D5.0	5.0	6	20	60	3	A	●
AL-3EL-D6.0	6.0	6	25	75	3	B	●
AL-3EL-D8.0	8.0	8	32	75	3	B	●
AL-3EL-D10.0	10.0	10	45	100	3	B	●
AL-3EL-D12.0	12.0	12	45	100	3	B	●
AL-3EL-D16.0	16.0	16	65	150	3	B	●
AL-3EL-D20.0	20.0	20	75	150	3	B	●

B

Solid Carbide end mills
Vollhartmetallschaftfräser

Material Overview · Material Übersicht

✓ = Very suitable · Sehr empfohlen
✓ = Suitable · Empfohlen

Workpiece material Werkstückstoff											
Carbon steel Kohlenstoff Stahl	Alloy steel Legierter Stahl	Quenched and tempered steel · Vergüteter Stahl		Hardened steel · Gehärteter Stahl		Stainless steel · Rostfreier Stahl	Cast iron, Nodular cast iron Grauguss GGG	Copper alloy Kupfer Leg	Aluminum alloy Alu Leg	Titanium alloy Titan Leg	Heat resist alloy warmfeste Leg
		~40HRC	~50HRC	~60HRC	~68HRC						
									✓		

YK 30F

Code key **B252, B254**
ISO Kennzeichen

Cutting data **B474**
Schnittdaten

Graphics identification & application **B253, B255**
Graphische Werkzeug- & Anwendungsbeschr.

Order form for non-standard products **B534-B535**
Bestellformular für Sonderwerkzeuge

B473

Milling · Fräsen

Solid Carbide end mills · Vollhartmetallschaftfräser

Recommended cutting data · Empfohlene Schnittdaten

AL-3E | AL-3EL

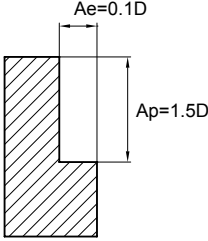
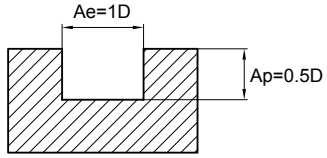
Workpiece material Werkstückmaterial	Aluminum alloy Alu Legierungen		Silicon aluminium alloy Si≤10% Silizium Alu Legierungen Si≤10%		
	Diameter Ø Durchmesser (mm)	Rotating Drehzahl (min ⁻¹)	Feed Vorschub (mm/min)	Rotating Drehzahl (min ⁻¹)	Feed Vorschub (mm/min)
1		40000	800	40000	600
2		40000	1200	32000	900
3		26500	1800	21000	1300
4		20000	2000	16000	1500
5		16000	1750	13000	1300
6		13000	1500	10600	1200
8		10000	1650	8000	1300
10		8000	1900	6500	1500
12		6600	1950	5300	1550
14		5700	2000	4600	1600
16		5000	2000	4000	1600
18		4400	2000	3500	1600
20		4000	2000	3200	1600
Max. cutting depth max Schnitttiefe					

1. The above table shows the reference value of side milling. The feed in slot milling is recommended 70% of reference value stated above.
2. Please select high rigid and precise machine and tool holder. Vibration and unusual noise may be generated if the machine rigidity and workpiece fixture stability is low, please reduce the rotating speed and feed stated above correspondingly.
3. It is possible to increase the rotating speed and feed correspondingly if the cutting depth is small.
4. Please use water-soluble cutting liquid.
5. Down milling is recommended in side milling.
6. Make overhang as short as possible if no interference.

1. Die obige Tabelle zeigt die Referenz Schnittdaten für das Eckfräsen.
Für das Nutenfräsen die obigen Schnittdaten um 30 % reduzieren.
2. Bitte Maschine und Werkzeugaufnahme mit hoher Präzision und Stabilität wählen. Bei Vibrationen oder unüblichen Geräuschen reduzieren Sie die Schnittdaten (wie oben empfohlen) entsprechend.
3. Schnittdaten bei kleinen Schnitttiefen erhöhen.
4. Bitte wasserlösliche Kühlmittel verwenden.
5. Fräsmethode zum Eckfräsen: Gleichlaufräsen.
6. Die Werkzeugauskragung so kurz wie möglich wählen.

● Ex Stock / ab Lager ○ On demand / auf Anfrage

ALG-3E

- 3-flute router with flat end cut (uncoated)
- 3-Schneider mit flachem Stirnanschliff (ohne Beschichtung)

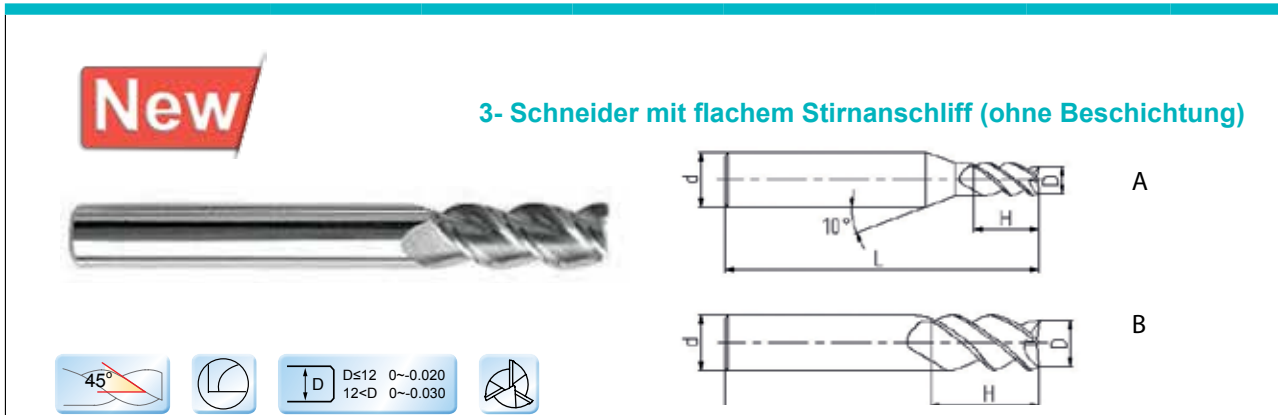

Type · Typ	Dimension (mm) Abmessungen				Teeth · Zähne Z	Geometry Ausführung	YK40F
	D	d	H	L			
ALG-3E-D1.0	1.0	4	3	50	3	A	●
ALG-3E-D1.5	1.5	4	4	50	3	A	●
ALG-3E-D2.0	2.0	4	6	50	3	A	●
ALG-3E-D2.5	2.5	4	8	50	3	A	●
ALG-3E-D3.0S	3.0	4	8	50	3	A	●
ALG-3E-D3.0	3.0	6	8	50	3	A	●
ALG-3E-D3.5S	3.5	4	10	50	3	A	○
ALG-3E-D3.5	3.5	6	10	50	3	A	○
ALG-3E-D4.0S	4.0	4	11	50	3	B	●
ALG-3E-D4.0	4.0	6	11	50	3	A	●
ALG-3E-D4.5	4.5	6	11	50	3	A	●
ALG-3E-D5.0	5.0	6	13	50	3	A	●
ALG-3E-D5.5	5.5	6	16	50	3	A	●
ALG-3E-D6.0	6.0	6	16	50	3	B	●
ALG-3E-D7.0	7.0	8	20	60	3	A	●
ALG-3E-D8.0	8.0	8	20	60	3	B	●
ALG-3E-D9.0	9.0	10	22	75	3	A	●
ALG-3E-D10.0	10.0	10	25	75	3	B	●
ALG-3E-D11.0	11.0	12	26	75	3	A	●
ALG-3E-D12.0	12.0	12	30	75	3	B	●
ALG-3E-D14.0	14.0	14	32	75	3	B	●
ALG-3E-D16.0	16.0	16	45	100	3	B	●
ALG-3E-D18.0	18.0	18	45	100	3	B	●
ALG-3E-D20.0	20.0	20	45	100	3	B	●

Further dimensions available on request
Weitere Abmessungen auf Anfrage lieferbar

Code key B252, B254
ISO Kennzeichen

Cutting data B476
Schnittdaten

Graphics identification & application B253, B255
Graphische Werkzeug- & Anwendungsbeschr.

Order form for non-standard products B534-B535
Bestellformular für Sonderwerkzeuge

Milling · Fräsen

Solid Carbide end mills · Vollhartmetallschaftfräser

Recommended cutting data · Empfohlene Schnittdaten

ALG-3E

Workpiece material Werkstückstoff	Aluminum alloy Alu-Legierungen		Silicon aluminium alloy Si≤10% Silizium-Alu-Legierungen Si≤10%		
	Diameter Durchmesser Ø (mm)	Rotating Drehzahl (min ⁻¹)	Feed Vorschub (mm/min)	Rotating Drehzahl (min ⁻¹)	Feed Vorschub (mm/min)
1		40000	800	40000	600
2		40000	1200	32000	900
3		26500	1800	21000	1300
4		20000	2000	16000	1500
5		16000	1750	13000	1300
6		13000	1500	10600	1200
8		10000	1650	8000	1300
10		8000	1900	6500	1500
12		6600	1950	5300	1550
14		5700	2000	4600	1600
16		5000	2000	4000	1600
18		4400	2000	3500	1600
20		4000	2000	3200	1600
Max. cutting depth max. Schnitttiefe					

B

Solid Carbide end mills
Vollhartmetallschaftfräser

● Ex Stock / ab Lager ○ On demand / auf Anfrage

ALP-3E

3-flute router with flat end cut (uncoated) (MQL)
3-Schneider mit flachem Stirnanschliff (unbeschichtet) (MMKS)

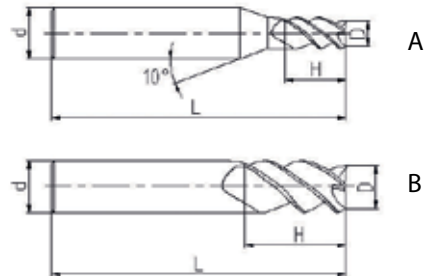

Type · Typ	Dimension (mm) Abmessungen				Teeth · Zähne Z	Geometry Ausführung	YK40F
	D	d	H	L			
ALP-3E-D1.0	1.0	4	3	50	3	A	●
ALP-3E-D1.5	1.5	4	4	50	3	A	●
ALP-3E-D2.0	2.0	4	6	50	3	A	●
ALP-3E-D2.5	2.5	4	8	50	3	A	●
ALP-3E-D3.0S	3.0	4	8	50	3	A	●
ALP-3E-D3.0	3.0	6	8	50	3	A	●
ALP-3E-D4.0S	4.0	4	11	50	3	B	●
ALP-3E-D4.0	4.0	6	11	50	3	A	●
ALP-3E-D4.5	4.5	6	11	50	3	A	●
ALP-3E-D5.0	5.0	6	13	50	3	A	●
ALP-3E-D5.5	5.5	6	16	50	3	A	●
ALP-3E-D6.0	6.0	6	16	50	3	B	●
ALP-3E-D7.0	7.0	8	20	60	3	B	●
ALP-3E-D8.0	8.0	8	20	60	3	B	●
ALP-3E-D9.0	9.0	10	22	75	3	B	●
ALP-3E-D10.0	10.0	10	25	75	3	B	●
ALP-3E-D11.0	11.0	12	26	75	3	B	●
ALP-3E-D12.0	12.0	12	30	75	3	B	●
ALP-3E-D14.0	14.0	14	32	75	3	B	●
ALP-3E-D16.0	16.0	16	45	100	3	B	●
ALP-3E-D20.0	20.0	20	45	100	3	B	○

Further dimensions available on request
Weitere Abmessungen auf Anfrage lieferbar

Code key B252, B254
ISO Kennzeichen

Cutting data B478
Schnittdaten

Graphics identification & application B253, B255
Graphische Werkzeug- & Anwendungsbeschr.

Order form for non-standard products B534-B535
Bestellformular für Sonderwerkzeuge

Milling · Fräsen

Solid Carbide end mills · Vollhartmetallschaftfräser

Recommended cutting data · Empfohlene Schnittdaten

ALP-3E

Workpiece material Werkstückstoff	Aluminum alloy Alu-Legierungen		Silicon aluminium alloy Si≤10% Silizium-Alu-Legierungen Si≤10%		
	Diameter Durchmesser Ø (mm)	Rotating Drehzahl (min ⁻¹)	Feed Vorschub (mm/min)	Rotating Drehzahl (min ⁻¹)	Feed Vorschub (mm/min)
1		40000	800	40000	600
2		40000	1200	32000	900
3		26500	1800	21000	1300
4		20000	2000	16000	1500
5		16000	1750	13000	1300
6		13000	1500	10600	1200
8		10000	1650	8000	1300
10		8000	1900	6500	1500
12		6600	1950	5300	1550
14		5700	2000	4600	1600
16		5000	2000	4000	1600
18		4400	2000	3500	1600
20		4000	2000	3200	1600
Max. cutting depth max. Schnitttiefe					

B

Solid Carbide end mills
Vollhartmetallschaftfräser

● Ex Stock / ab Lager ○ On demand / auf Anfrage

ALP-4E

- 4-flute router with flat end cut (uncoated) (MQL)
- 4-Schneider mit flachem Stirnanschliff (unbeschichtet) (MMKS)

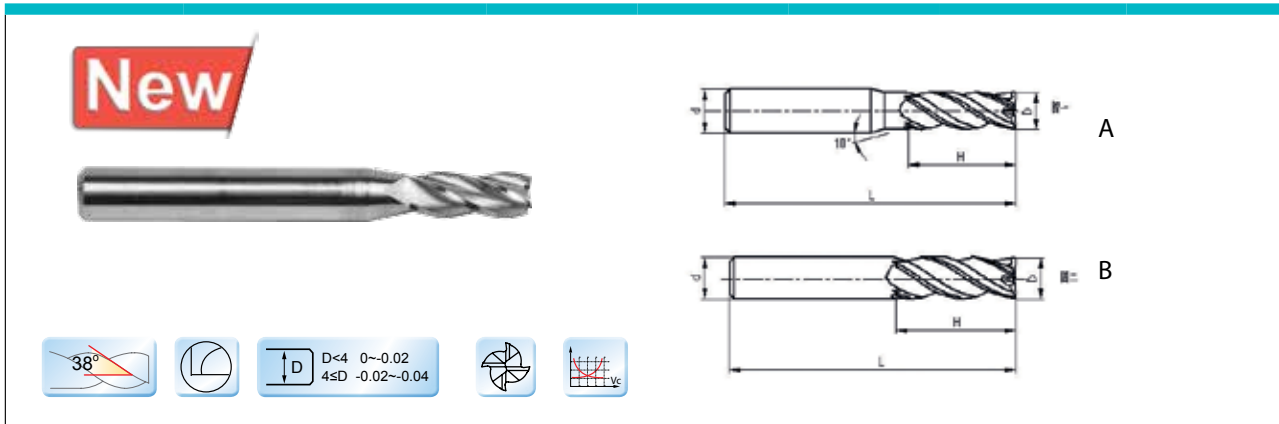

Type · Typ	Dimension (mm) Abmessungen				Teeth · Zähne Z	Geometry Ausführung	YK40F
	D	d	H	L			
ALP-4E-D3.0S	3	4	9	50	4	A	●
ALP-4E-D3.0	3	6	9	50	4	A	●
ALP-4E-D4.0S	4	4	11	50	4	B	●
ALP-4E-D4.0	4	6	11	50	4	A	●
ALP-4E-D5.0	5	6	13	50	4	A	●
ALP-4E-D6.0	6	6	16	50	4	B	●
ALP-4E-D8.0	8	8	20	60	4	B	●
ALP-4E-D10.0	10	10	25	75	4	B	●
ALP-4E-D12.0	12	12	30	75	4	B	●
ALP-4E-D16.0	16	16	45	100	4	B	●
ALP-4E-D18.0	18	18	45	100	4	B	●
ALP-4E-D20.0	20	20	45	100	4	B	●

Further dimensions available on request
 Weitere Abmessungen auf Anfrage lieferbar

B
 Solid Carbide end mills
 Vollhartmetallschaftfräser

Milling · Fräsen

Solid Carbide end mills · Vollhartmetallschaftfräser

Recommended cutting data · Empfohlene Schnittdaten

ALP-4E

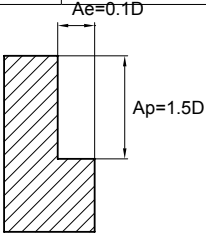
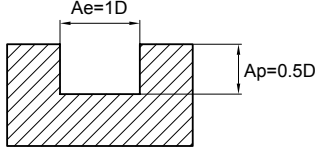
Workpiece material Werkstückstoff	Milling Nuten Fräsen		Milling Schulterfräsen	
	Diameter Durchmesser Ø (mm)	Rotating Drehzahl (min ⁻¹)	Feed Vorschub (mm/min)	Rotating Drehzahl (min ⁻¹)
1	95.000	0,003	110.000	0,003
2	50.000	0,005	80.000	0,005
3	47.000	0,010	72.000	0,010
4	35.000	0,015	55.000	0,015
5	28.000	0,020	45.000	0,020
6	24.000	0,024	38.000	0,024
8	18.000	0,032	28.000	0,032
10	14.000	0,038	22.000	0,038
12	12.000	0,046	18.000	0,046
16	10.000	0,054	14.000	0,054
20	8.000	0,066	12.000	0,066
Max. cutting depth max. Schnitttiefe				

B

Solid Carbide end mills
Vollhartmetallschaftfräser

● Ex Stock / ab Lager ○ On demand / auf Anfrage

AL-3W series for machining aluminium · **AL-3W** Serie für die Bearbeitung von Aluminium

3-flute rough end mills with straight shank, rough pitch form
3-Schneiden Schruppfräser mit Zylinderschaft, grob verzahnt

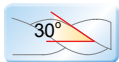
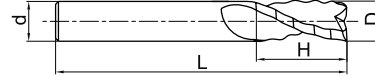
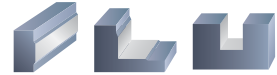

D ≤ 6	0 ~ -0.048	6 < D ≤ 10	0 ~ -0.058
10 < D ≤ 18	0 ~ -0.07	18 < D	0 ~ -0.084



Type Typ	Dimension(mm) Abmessungen				Teeth Zähne Z	Grade Sorte YK30F
	D	d	H	L		
AL-3W-D6.0	6	6	16	50	3	●
AL-3W-D8.0	8	8	20	60	3	●
AL-3W-D10.0	10	10	25	75	3	●
AL-3W-D12.0	12	12	30	75	3	●
AL-3W-D16.0	16	16	45	100	3	●
AL-3W-D20.0	20	20	45	100	3	●

B

Solid Carbide end mills
Vollhartmetallschaftfräser

Material Overview · Material Übersicht

✓ = Very suitable · Sehr empfohlen
 ✓ = Suitable · Empfohlen

Workpiece material Werkstückstoff											
Carbon steel Kohlenstoff Stahl	Alloy steel Legierter Stahl	Quenched and tempered steel · Vergüteter Stahl		Hardened steel · Gehärteter Stahl		Stainless steel · Rostfreier Stahl	Cast iron, Nodular cast iron Grauguss GGG	Copper alloy Kupfer Leg	Aluminum alloy Alu Leg	Titanium alloy Titan Leg	Heat resist alloy warmfeste Leg
		~40HRC	~50HRC	~60HRC	~68HRC						
									✓		

YK 30F

Code key **B252,B254**
ISO Kennzeichen

Cutting data **B482**
Schnittdaten

Graphics identification & application **B253,B255**
Graphische Werkzeug- & Anwendungsbeschr.

Order form for non-standard products **B534-B535**
Bestellformular für Sonderwerkzeuge

B481

Milling · Fräsen

Solid Carbide end mills · Vollhartmetallschaftfräser

Recommended cutting data · Empfohlene Schnittdaten

AL-3W

Workpiece material Werkstückstoff	Aluminum alloy Alu Legierungen		Silicon aluminium alloy Si≤10% Silizium Alu Legierungen Si≤10%	
Cutting speed Schnittgeschw.	250m/min		200m/min	
Diameter Ø Durchmesser (mm)	Rotating Drehzahl (min ⁻¹)	Feed Vorschub (mm/min)	Rotating Drehzahl (min ⁻¹)	Feed Vorschub (mm/min)
6	13000	3000	10600	1900
8	10000	3000	8000	1900
10	8000	2900	6500	1850
12	6600	2700	5300	1700
14	5700	2600	4600	1650
16	5000	2550	4000	1600
18	4400	2500	3500	1550
20	4000	2400	3200	1500

Max. cutting depth max Schnitttiefe	<p>Ae=0.25D Ap=1.5D</p>	<p>Ae=1D Ap=1D</p>
--	-----------------------------	------------------------

- The above table shows the reference value of side milling. When milling slot, rotating speed is around 70% of standard value, Feed is around 50% of standard value.
- Please select high rigid and precise machine and tool holder. Vibration and unusual noise may be generated if the machine rigidity and workpiece fixture stability is low, please reduce the rotating speed and feed stated above correspondingly.
- It is possible to increase the rotating speed and feed correspondingly if the cutting depth is small.
- Please use water-soluble cutting liquid.
- Down milling is recommended in side milling.
- Make overhang as short as possible if no interference.

- Die obige Tabelle zeigt die Referenz Schnittdaten für das Eckfräsen.
Für das Nutenfräsen die obigen Schnittdaten auf 70 % reduzieren.
- Bitte präzise Maschinen und Werkzeughalter verwenden. Bei Vibrationen oder ungewöhnlichen Geräuschen reduzieren Sie die Schnittdaten (wie oben empfohlen) entsprechend.
- Schnittdaten bei kleinen Schnitttiefen erhöhen.
- Bitte wasserlösliche Kühlmittel verwenden.
- Fräsmethode zum Eckfräsen: Gleichlaufräsen.
- Die Werkzeugauskrantung so kurz wie möglich wählen.

● Ex Stock / ab Lager ○ On demand / auf Anfrage

ZCC CT series for machining aluminium · **ZCC CT** Serie für die Bearbeitung von Aluminium

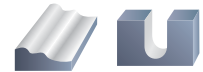

5565R302NH

YK40F: Ultrafine carbide / Ultrafeinkornhartmetall

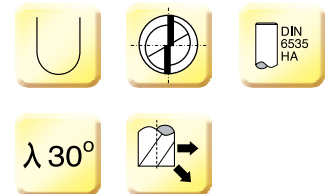
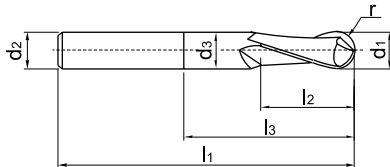

Type Typ	Dimension(mm) Abmessungen								Teeth Zähne	Application Anwendung	N
	d1	d2(h6)	l2	l1	d3	l3	r(f8)	α°			
5565R302NH-0300	3.00	6	6	57	2.80	9	1.50	6	2		•
5565R302NH-0400	4.00	6	8	57	3.70	12	2.00	4	2		•
5565R302NH-0500	5.00	6	10	57	4.60	15	2.50	2	2		•
5565R302NH-0600	6.00	6	12	57	5.50	20	3.00	-	2		•
5565R302NH-0800	8.00	8	16	63	7.40	26	4.00	-	2		•
5565R302NH-1000	10.00	10	20	72	9.20	31	5.00	-	2		•
5565R302NH-1200	12.00	12	24	83	11.00	37	6.00	-	2		•
5565R302NH-1600	16.00	16	32	92	15.00	43	8.00	-	2		•

Art. Group No. / Produktgruppe Nr. :

023140

B

Solid Carbide end mills
Vollhartmetallschaftfräser

Material Overview · Material Übersicht

✓ = Very suitable · Sehr empfohlen
✓ = Suitable · Empfohlen

YK 40F

Workpiece material Werkstückstoff											
Carbon steel Kohlenstoff Stahl	Alloy steel Legierter Stahl	Quenched and tempered steel · Vergüteter Stahl		Hardened steel · Gehärteter Stahl		Stainless steel · Rostfreier Stahl	Cast iron, Nodular cast iron Grauguss GGG	Copper alloy Kupfer Leg	Aluminum alloy Alu Leg	Titanium alloy Titan Leg	Heat resist alloy warmfeste Leg
		~40HRC	~50HRC	~60HRC	~68HRC						
									✓		

Code key **B252,B254**
ISO Kennzeichen

Cutting data **B486-B488**
Schnittdaten

Graphics identification & application **B253,B255**
Graphische Werkzeug- & Anwendungsbeschr.

Order form for non-standard products **B534-B535**
Bestellformular für Sonderwerkzeuge

B483

Milling · Fräsen

Solid Carbide end mills · Vollhartmetallschaftfräser

ZCC CT series for machining aluminium · **ZCC CT** Serie für die Bearbeitung von Aluminium



5566R302NH

YK40F: Ultrafine carbide / Ultrafeinkornhartmetall

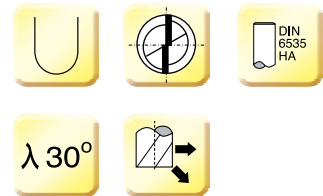
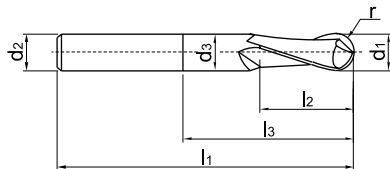

Type Typ	Dimension(mm) Abmessungen								Teeth Zähne	Application Anwendung	N
	d1	d2(h6)	l2	l1	d3	l3	r(f8)	α°	z	Grade Sorte	YK40F
5566R302NH-0300	3.00	6	6	75	2.80	9	1.50	6	2		●
5566R302NH-0400	4.00	6	8	75	3.70	12	2.00	4	2		●
5566R302NH-0500	5.00	6	10	80	4.60	15	2.50	2	2		●
5566R302NH-0600	6.00	6	12	80	5.50	20	3.00	-	2		●
5566R302NH-0800	8.00	8	16	90	7.40	26	4.00	-	2		●
5566R302NH-1000	10.00	10	20	100	9.20	31	5.00	-	2		●
5566R302NH-1200	12.00	12	24	120	11.00	37	6.00	-	2		●
5566R302NH-1600	16.00	16	32	140	15.00	43	8.00	-	2		●

Art. Group No. / Produktgruppe Nr. :

023140

Material Overview · Material Übersicht

✓ = Very suitable · Sehr empfohlen
 ✓ = Suitable · Empfohlen

Workpiece material Werkstückstoff											
Carbon steel Kohlenstoff Stahl	Alloy steel Legierter Stahl	Quenched and tempered steel · Vergüteter Stahl		Hardened steel · Gehärteter Stahl		Stainless steel · Rostfreier Stahl	Cast iron, Nodular cast iron Grauguss GGG	Copper alloy Kupfer Leg	Aluminum alloy Alu Leg	Titanium alloy Titan Leg	Heat resist alloy warmfeste Leg
		~40HRC	~50HRC	~60HRC	~68HRC						
									✓		

● Ex Stock / ab Lager ○ On demand / auf Anfrage

YK 40F

AL-2B series for machining aluminium · **AL-2B** Serie für die Bearbeitung von Aluminium

2-flute ball nose end mills with straight shank
2-Schneiden Kugelkopffräser mit Zylinderschaft

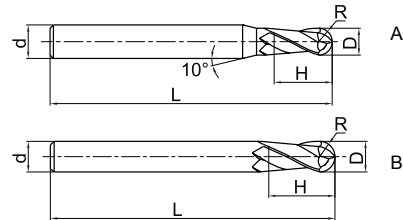

Type Typ	Dimension(mm) Abmessungen					Teeth Zähne Z	Geometry Ausführung	Grade Sorte YK30F
	D	R	d	H	L			
AL-2B-R1.0	2.0	1.0	6.0	4.0	60	2	A	●
AL-2B-R1.5	3.0	1.5	6.0	6.0	60	2	A	●
AL-2B-R2.0	4.0	2.0	6.0	8.0	60	2	A	●
AL-2B-R2.5	5.0	2.5	6.0	10.0	60	2	A	●
AL-2B-R3.0	6.0	3.0	6.0	12.0	60	2	B	●
AL-2B-R4.0	8.0	4.0	8.0	16.0	75	2	B	●
AL-2B-R5.0	10.0	5.0	10.0	20.0	75	2	B	●
AL-2B-R6.0	12.0	6.0	12.0	24.0	75	2	B	●

B

Solid Carbide end mills
Vollhartmetallschaftfräser

Material Overview · Material Übersicht

✓ = Very suitable · Sehr empfohlen
 ✓ = Suitable · Empfohlen

YK 30F

Workpiece material Werkstückstoff											
Carbon steel Kohlenstoff Stahl	Alloy steel Legierter Stahl	Quenched and tempered steel · Vergüteter Stahl		Hardened steel · Gehärteter Stahl		Stainless steel · Rostfreier Stahl	Cast iron, Nodular cast iron Grauguss GGG	Copper alloy Kupfer Leg	Aluminum alloy Alu Leg	Titanium alloy Titan Leg	Heat resist alloy warmfeste Leg
		~40HRC	~50HRC	~60HRC	~68HRC						
									✓		

Code key **B252,B254**
ISO Kennzeichen

Cutting data **B486-B488**
Schnittdaten

Graphics identification & application **B253,B255**
Graphische Werkzeug- & Anwendungsbeschr.



Order form for non-standard products **B534-B535**
Bestellformular für Sonderwerkzeuge

B485

Milling - Fräsen

Solid Carbide end mills - Vollhartmetallschaftfräser

Recommended cutting data - Empfohlene Schnittdaten

Type Typ	Grade Sorte	Material Werkstoffe	d1 (mm)	z	Vc (m/min)	fz (mm/z)	ap (mm)	ae (mm)	d _{eff} (mm)	n (min ⁻¹)	Vf (mm/min)
5565R302NH  	YK40F	N Forged aluminum alloy <i>Geschmiedete Al-Legierung</i> Cast aluminum alloy <i>Al-Gusslegierung</i> Si<6%	3.00	2	900	0.060	0.30	0.60	1.80		
			4.00	2	900	0.080	0.40	0.80	2.40		
			5.00	2	900	0.100	0.50	1.00	3.00		
			6.00	2	900	0.120	0.60	1.20	3.60		
			8.00	2	900	0.150	0.80	1.60	4.80		
			10.00	2	900	0.140	1.00	2.00	6.00		
			12.00	2	900	0.170	1.20	2.40	7.20		
			16.00	2	900	0.210	1.60	3.20	9.60		
			3.00	2	600	0.060	0.30	0.60	1.80		
			4.00	2	600	0.080	0.40	0.80	2.40		
			5.00	2	600	0.100	0.50	1.00	3.00		
			6.00	2	600	0.120	0.60	1.20	3.60		
			8.00	2	600	0.150	0.80	1.60	4.80		
			10.00	2	600	0.140	1.00	2.00	6.00		
		12.00	2	600	0.170	1.20	2.40	7.20			
		16.00	2	600	0.210	1.60	3.20	9.60			
		3.00	2	1200	0.060	0.30	0.60	1.80			
		4.00	2	1200	0.080	0.40	0.80	2.40			
		5.00	2	1200	0.100	0.50	1.00	3.00			
		6.00	2	1200	0.120	0.60	1.20	3.60			
		8.00	2	1200	0.150	0.80	1.60	4.80			
		10.00	2	1200	0.140	1.00	2.00	6.00			
		12.00	2	1200	0.170	1.20	2.40	7.20			
		16.00	2	1200	0.210	1.60	3.20	9.60			

- Please start a test cutting with 85% of the Vc or 75% of the fz, then increase the cutting speed and feed rate.
- Please use high precision and high rigidity clamping system. The oscillation of the tool can not be over 0.01 mm.
 $N = 1000Vc / d_{eff} / 3.14159$
 When the rotating speed of the machine on site cannot reach the maximum rotation speed of the machine used for the calculation of the rotating speed: $Vf = fz * n * z$ (n: actual rotation of the machine).



- Bitte führen Sie einen Testschnitt mit 85% der Vc und 75% des fz durch.
 Nach erfolgtem Test können Sie die Schnittgeschwindigkeit bzw. die Vorschubwerte entsprechend erhöhen.
- Bitte verwenden Sie nur Spannmittel mit einer hohen Genauigkeit und einer hohen Spannkraft.
 Überprüfen Sie den Rundlauf der Werkzeuge. Sie sollten darauf achten, dass der Rundlauffehler nicht größer als 0.01 mm ist.

Sollten Sie aufgrund der Machinendrehzahl nicht in der Lage sein, die angegebenen Drehzahlen ein zuhalten, achten Sie darauf, dass Sie die Vf entsprechend anpassen. $Vf = fz * n * z$ (n: aktuelle Machinendrehzahl).

B

Solid Carbide end mills
Vollhartmetallschaftfräser

Recommended cutting data · Empfohlene Schnittdaten

Type Typ	Grade Sorte	Material Werkstoffe	d ₁ (mm)	z	V _c (m/min)	f _z (mm/z)	a _p (mm)	a _e (mm)	d _{eff} (mm)	n (min ⁻¹)	V _f (mm/min)
 	YK40F	N Forged aluminum alloy Geschmiedete Al-Legierung Cast aluminum alloy Al-Gusslegierung Si<6%	3.00	2	650	0.060	0.15	0.30	1.31		
			4.00	2	650	0.080	0.20	0.40	1.74		
			5.00	2	650	0.100	0.25	0.50	2.18		
			6.00	2	650	0.090	0.30	0.60	2.62		
			8.00	2	650	0.120	0.40	0.80	3.49		
			10.00	2	650	0.150	0.50	1.00	4.36		
			12.00	2	650	0.120	0.60	1.20	5.23		
			16.00	2	650	0.160	0.80	1.60	6.97		
			3.00	2	480	0.060	0.15	0.30	1.31		
			4.00	2	480	0.080	0.20	0.40	1.74		
			5.00	2	480	0.100	0.25	0.50	2.18		
			6.00	2	480	0.090	0.30	0.60	2.62		
			8.00	2	480	0.120	0.40	0.80	3.49		
			10.00	2	480	0.150	0.50	1.00	4.36		
		12.00	2	480	0.120	0.60	1.20	5.23			
		16.00	2	480	0.160	0.80	1.60	6.97			
		3.00	2	950	0.060	0.15	0.30	1.31			
		4.00	2	950	0.080	0.20	0.40	1.74			
		5.00	2	950	0.100	0.25	0.50	2.18			
		6.00	2	950	0.090	0.30	0.60	2.62			
		8.00	2	950	0.120	0.40	0.80	3.49			
		10.00	2	950	0.150	0.50	1.00	4.36			
		12.00	2	950	0.120	0.60	1.20	5.23			
		16.00	2	950	0.160	0.80	1.60	6.97			

- Please start a test cutting with 85% of the V_c or 75% of the f_z, then increase the cutting speed and feed rate.
- Please use high precision and high rigidity clamping system. The oscillation of the tool can not be over 0.01 mm.

$$N = 1000V_c / d_{eff} / 3.14159$$

When the rotating speed of the machine on site cannot reach the maximum rotation speed of the machine used for the calculation of the rotating speed: $V_f = f_z * n * z$ (n: actual rotation of the machine).

- Bitte führen Sie einen Testschnitt mit 85% der V_c und 75% des f_z durch.
Nach erfolgtem Test können Sie die Schnittgeschwindigkeit bzw. die Vorschubwerte entsprechend erhöhen.
- Bitte verwenden Sie nur Spannmittel mit einer hohen Genauigkeit und einer hohen Spannkraft.
Überprüfen Sie den Rundlauf der Werkzeuge. Sie sollten darauf achten, dass der Rundlauffehler nicht größer als 0.01 mm ist.

Sollten Sie aufgrund der Machinendrehzahl nicht in der Lage sein, die angegebenen Drehzahlen ein zuhalten, achten Sie darauf, dass Sie die V_f entsprechend anpassen. $V_f = f_z * n * z$ (n: aktuelle Machinendrehzahl).

Milling · Fräsen

Solid Carbide end mills · Vollhartmetallschaftfräser

Recommended cutting data · Empfohlene Schnittdaten

AL-2B

Workpiece material Werkstückmaterial	Aluminum alloy Alu Legierungen		Silicon aluminium alloy Si≤10% Silizium Alu Legierungen Si≤10%		
	Diameter Ø Durchmesser (mm)	Rotating Drehzahl (min ⁻¹)	Feed Vorschub (mm/min)	Rotating Drehzahl (min ⁻¹)	Feed Vorschub (mm/min)
R1.0		40000	2000	32000	1600
R1.5		26500	1950	21000	1550
R2.0		20000	1950	16000	1550
R2.5		16000	1950	13000	1550
R3.0		13000	2000	10600	1600
R4.0		10000	2450	8000	2000
R5.0		8000	2200	6500	1750
R6.0		6600	2050	5300	1650
Max. cutting depth max Schnitttiefe					

1. Please select high rigid and precise machine and tool holder. Vibration and unusual noise may be generated if the machine rigidity and workpiece fixture stability is low, please reduce the rotating speed and feed stated above correspondingly.
2. It is possible to increase the rotating speed and feed correspondingly if the cutting depth is small.
3. Please use water-soluble cutting liquid.
4. Make overhang as short as possible if no interference.

1. Bitte Maschine und Werkzeugaufnahme mit hoher Präzision und Stabilität wählen. Bei Vibrationen oder unüblichen Geräuschen reduzieren Sie die Schnittdaten (wie oben empfohlen) entsprechend.
2. Schnittdaten bei kleinen Schnitttiefen erhöhen.
3. Bitte wasserlösliche Kühlmittel verwenden.
4. Die Werkzeugauskragung so kurz wie möglich wählen.

● Ex Stock / ab Lager ○ On demand / auf Anfrage

AL-2R-AIR series for machining aluminium · **AL-2R-AIR** Serie für die Bearbeitung von Aluminium

2-flute end mills with straight shank
2-Schneiden Schaftfräser mit Zylinderschaft



Ultrahigh speed
HSC

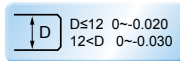
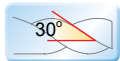
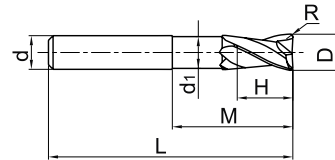

Type Typ	Dimension(mm) Abmessungen							Teeth Zähne Z	Grade Sorte YK40F
	D	R	d	d ₁	H	M	L		
AL-2R-D6.0R1.0- AIR	6	1.0	6	5.5	7	20	57	2	●
AL-2R-D8.0R1.0- AIR	8	1.0	8	7.4	9	26	63	2	●
AL-2R-D10.0R1.0- AIR	10	1.0	10	9.2	11	31	72	2	●
AL-2R-D10.0R2.0- AIR	10	2.0	10	9.2	11	31	72	2	●
AL-2R-D12.0R1.0- AIR	12	1.0	12	11	12	37	83	2	●
AL-2R-D12.0R2.0- AIR	12	2.0	12	11	12	37	83	2	●
AL-2R-D12.0R3.0- AIR	12	3.0	12	11	12	37	83	2	●
AL-2R-D16.0R1.0- AIR	16	1.0	16	15	16	43	92	2	●
AL-2R-D16.0R2.0- AIR	16	2.0	16	15	16	43	92	2	●
AL-2R-D16.0R3.0- AIR	16	3.0	16	15	16	43	92	2	●
AL-2R-D16.0R4.0- AIR	16	4.0	16	15	16	43	92	2	●
AL-2R-D20.0R1.0- AIR	20	1.0	20	19	20	53	104	2	●
AL-2R-D20.0R2.0- AIR	20	2.0	20	19	20	53	104	2	●
AL-2R-D20.0R3.0- AIR	20	3.0	20	19	20	53	104	2	●
AL-2R-D20.0R4.0- AIR	20	4.0	20	19	20	53	104	2	○
AL-2R-D20.0R5.0- AIR	20	5.0	20	19	20	53	104	2	●
AL-2R-D20.0R6.0- AIR	20	6.0	20	19	20	53	104	2	○

for air space industry · für Luft- und Raumfahrt - Industrie

Material Overview · Material Übersicht

✓ = Very suitable · Sehr empfohlen
✓ = Suitable · Empfohlen

YK 40F

Workpiece material Werkstückstoff											
Carbon steel Kohlenstoff Stahl	Alloy steel Legierter Stahl	Quenched and tempered steel · Vergüteter Stahl		Hardened steel · Gehärteter Stahl		Stainless steel · Rostfreier Stahl	Cast iron, Nodular cast iron Grauguss GGG	Copper alloy Kupfer Leg	Aluminum alloy Alu Leg	Titanium alloy Titan Leg	Heat resist alloy warmfeste Leg
		~40HRC	~50HRC	~60HRC	~68HRC						
									✓		

Code key **B252,B254**
ISO Kennzeichen

Cutting data **B491-B492**
Schnittdaten

Graphics identification & application **B253,B255**
Graphische Werkzeug- & Anwendungsbeschr.

Order form for non-standard products **B534-B535**
Bestellformular für Sonderwerkzeuge

Milling · Fräsen

Solid Carbide end mills · Vollhartmetallschaftfräser

AL-2RL-AIR series for machining aluminium · **AL-2RL-AIR** Serie für die Bearbeitung von Aluminium

2-flute radius end mills with long straight shank
2-Schneiden Radiusfräser mit langem Zylinderschaft



Ultrahigh speed
HSC

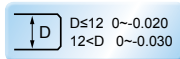
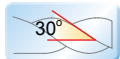
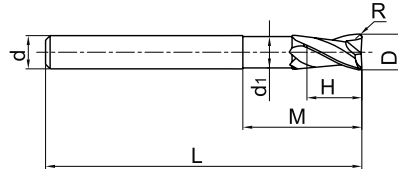

Type Typ	Dimension(mm) Abmessungen							Teeth Zähne Z	Grade Sorte YK40F
	D	R	d	d ₁	H	M	L		
AL-2RL-D6.0R1.0- AIR	6	1.0	6	5.5	7	43	80	2	●
AL-2RL-D8.0R1.0- AIR	8	1.0	8	7.4	9	53	90	2	●
AL-2RL-D10.0R1.0- AIR	10	1.0	10	9.2	11	59	100	2	●
AL-2RL-D10.0R2.0- AIR	10	2.0	10	9.2	11	59	100	2	●
AL-2RL-D12.0R1.0- AIR	12	1.0	12	11	12	74	120	2	●
AL-2RL-D12.0R2.0- AIR	12	2.0	12	11	12	74	120	2	●
AL-2RL-D12.0R3.0- AIR	12	3.0	12	11	12	74	120	2	○
AL-2RL-D16.0R1.0- AIR	16	1.0	16	15	16	84	140	2	●
AL-2RL-D16.0R2.0- AIR	16	2.0	16	15	16	84	140	2	●
AL-2RL-D16.0R3.0- AIR	16	3.0	16	15	16	84	140	2	●
AL-2RL-D16.0R4.0- AIR	16	4.0	16	15	16	84	140	2	●
AL-2RL-D20.0R1.0- AIR	20	1.0	20	19	20	89	140	2	○
AL-2RL-D20.0R2.0- AIR	20	2.0	20	19	20	89	140	2	●
AL-2RL-D20.0R3.0- AIR	20	3.0	20	19	20	89	140	2	●
AL-2RL-D20.0R4.0- AIR	20	4.0	20	19	20	89	140	2	●
AL-2RL-D20.0R5.0- AIR	20	5.0	20	19	20	89	140	2	○
AL-2RL-D20.0R6.0- AIR	20	6.0	20	19	20	89	140	2	○

for air space industry · für Luft- und Raumfahrt - Industrie

Material Overview · Material Übersicht

✓ = Very suitable · Sehr empfohlen
✓ = Suitable · Empfohlen

YK 40F

Workpiece material Werkstückstoff											
Carbon steel Kohlenstoff Stahl	Alloy steel Legierter Stahl	Quenched and tempered steel · Vergüteter Stahl		Hardened steel · Gehärteter Stahl		Stainless steel · Rostfreier Stahl	Cast iron, Nodular cast iron Grauguss GGG	Copper alloy Kupfer Leg	Aluminum alloy Alu Leg	Titanium alloy Titan Leg	Heat resist alloy warmfeste Leg
		~40HRC	~50HRC	~60HRC	~68HRC						
									✓		

● Ex Stock / ab Lager ○ On demand / auf Anfrage

Recommended cutting data · Empfohlene Schnittdaten

AL-2R-AIR

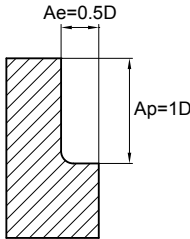
Workpiece material Werkstückstoff	Aluminum alloy Alu Legierungen		Silicon aluminium alloy Si≤10% Silizium Alu Legierungen Si≤10%	
Cutting speed Schnittgeschw.	500~800m/min		500~800m/min	
Diameter Ø Durchmesser (mm)	Rotating Drehzahl (min ⁻¹)	Feed Vorschub (mm/min)	Rotating Drehzahl (min ⁻¹)	Feed Vorschub (mm/min)
6	35000	3500	35000	3500
8	26000	3800	26000	3800
10	21000	4000	21000	4000
12	18000	4300	18000	4300
16	15000	4800	15000	4800
20	12000	5500	12000	5500
Max. cutting depth max Schnitttiefe	 <p>The diagram illustrates the maximum cutting depth parameters for a ball nose end mill. It shows a cross-section of the tool cutting into a workpiece. The axial cutting depth is labeled as $A_e = 0.5D$, where D is the diameter of the tool. The radial cutting depth is labeled as $A_p = 1D$.</p>			

1. The cutting parameters above are applied for high speed machining Al alloy.
2. Please use cutting liquid or strong air blow to remove chips.
3. Sparks generated during machining process or heat caused by tool breakage may cause burning or fire. Please be careful of fireproof.
4. Dynamic balance test must be done before machining.

1. Obige Schnittdaten sind Hochgeschwindigkeits-Schnittdaten für die Bearbeitung von Alu Legierungen.
2. Bitte Kühlschmiermittel oder Luft mit hohem Druck zur Spanabfuhr benutzen.
3. Während der Bearbeitung können durch Funken Feuer entstehen. Bitte Vorkehrungen treffen.
4. Dynamische Auswuchtvorschriften beachten.

Milling · Fräsen

Solid Carbide end mills · Vollhartmetallschaftfräser

Recommended cutting data · Empfohlene Schnittdaten

AL-2RL-AIR

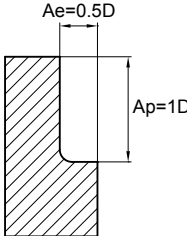
Workpiece material Werkstückstoff	Aluminum alloy Alu Legierungen		Silicon aluminium alloy Si≤10% Silizium Alu Legierungen Si≤10%	
Cutting speed Schnittgeschw.	500~800m/min		500~800m/min	
Diameter Ø Durchmesser (mm)	Rotating Drehzahl (min ⁻¹)	Feed Vorschub (mm/min)	Rotating Drehzahl (min ⁻¹)	Feed Vorschub (mm/min)
6	30000	3000	30000	3000
8	24000	3200	24000	3200
10	20000	3500	20000	3500
12	16000	3800	16000	3800
16	12000	4000	12000	4000
20	10000	4600	10000	4600
Max. cutting depth max Schnitttiefe	 <p>The diagram illustrates the maximum cutting depth parameters for a ball-nose end mill. It shows a cross-section of the tool cutting into a workpiece. The axial cutting depth is labeled as $A_e = 0.5D$, where D is the diameter of the tool. The radial cutting depth is labeled as $A_p = 1D$.</p>			

1. The cutting parameters above are applied for high speed machining Al alloy.
2. Please use cutting liquid or strong air blow to remove chips.
3. Sparks generated during machining process or heat caused by tool breakage may cause burning or fire. Please be careful of fireproof.
4. Dynamic balance test must be done before machining.

1. Obige Schnittdaten sind Hochgeschwindigkeits-Schnittdaten für die Bearbeitung von Alu Legierungen.
2. Bitte Kühlschmiermittel oder Luft mit hohem Druck zur Spanabfuhr benutzen.
3. Während der Bearbeitung können durch Funken Feuer entstehen. Bitte Vorkehrungen treffen.
4. Dynamische Auswuchtvorschriften beachten.

● Ex Stock / ab Lager ○ On demand / auf Anfrage

AL-3R-AIR series for machining aluminium · **AL-3R-AIR** Serie für die Bearbeitung von Aluminium

3-flute radius end mills with straight shank
3-Schneiden Radiusfräser mit langem Zylinderschaft



Ultrahigh speed

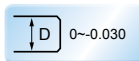
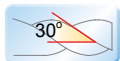
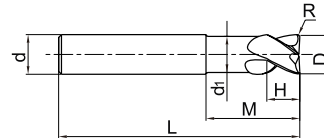

Type Typ	Dimension (mm) Abmessungen							Teeth Zähne Z	Grade Sorte YK40F
	D	R	d	d ₁	H	M	L		
AL-3R-D12.0R1.0- AIR	12	1.0	12	11	12	37	83	3	●
AL-3R-D12.0R2.0- AIR	12	2.0	12	11	12	37	83	3	●
AL-3R-D12.0R3.0- AIR	12	3.0	12	11	12	37	83	3	●
AL-3R-D16.0R1.0- AIR	16	1.0	16	15	16	43	92	3	●
AL-3R-D16.0R2.0- AIR	16	2.0	16	15	16	43	92	3	●
AL-3R-D16.0R3.0- AIR	16	3.0	16	15	16	43	92	3	●
AL-3R-D16.0R4.0- AIR	16	4.0	16	15	16	43	92	3	●
AL-3R-D20.0R1.0- AIR	20	1.0	20	19	20	53	104	3	●
AL-3R-D20.0R2.0- AIR	20	2.0	20	19	20	53	104	3	○
AL-3R-D20.0R3.0- AIR	20	3.0	20	19	20	53	104	3	○
AL-3R-D20.0R4.0- AIR	20	4.0	20	19	20	53	104	3	○
AL-3R-D20.0R5.0- AIR	20	5.0	20	19	20	53	104	3	●
AL-3R-D20.0R6.0- AIR	20	6.0	20	19	20	53	104	3	○

for air space industry · für Luft- und Raumfahrt - Industrie

B

Solid Carbide end mills
Vollhartmetallschaftfräser

Material Overview · Material Übersicht

✓ = Very suitable · Sehr empfohlen
✓ = Suitable · Empfohlen

Workpiece material Werkstückstoff											
Carbon steel Kohlenstoff Stahl	Alloy steel Legierter Stahl	Quenched and tempered steel · Vergüteter Stahl		Hardened steel · Gehärteter Stahl		Stainless steel · Rostfreier Stahl	Cast iron, Nodular cast iron Grauguss GGG	Copper alloy Kupfer Leg	Aluminum alloy Alu Leg	Titanium alloy Titan Leg	Heat resist alloy warmfeste Leg
		~40HRC	~50HRC	~60HRC	~68HRC						
									✓		

YK 40F

Code key B252,B254
ISO Kennzeichen

Cutting data B495-B496
Schnittdaten

Graphics identification & application B253,B255
Graphische Werkzeug- & Anwendungsbeschr.

Order form for non-standard products B534-B535
Bestellformular für Sonderwerkzeuge

Milling · Fräsen

Solid Carbide end mills · Vollhartmetallschaftfräser

AL-3RL-AIR series for machining aluminium · **AL-3RL-AIR** Serie für die Bearbeitung von Aluminium

3-flute radius end mills with long straight shank
3-Schneiden Radiusfräser mit langem Zylinderschaft



Ultrahigh speed
HSC

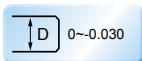
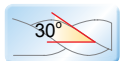
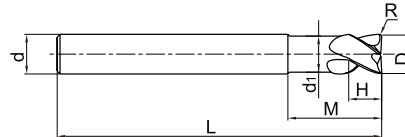

Type Typ	Dimension(mm) Abmessungen							Teeth Zähne Z	Grade Sorte YK40F
	D	R	d	d ₁	H	M	L		
AL-3RL-D12.0R1.0- AIR	12	1.0	12	11	12	74	120	3	●
AL-3RL-D12.0R2.0- AIR	12	2.0	12	11	12	74	120	3	●
AL-3RL-D12.0R3.0- AIR	12	3.0	12	11	12	74	120	3	●
AL-3RL-D16.0R1.0- AIR	16	1.0	16	15	16	84	140	3	●
AL-3RL-D16.0R2.0- AIR	16	2.0	16	15	16	84	140	3	○
AL-3RL-D16.0R3.0- AIR	16	3.0	16	15	16	84	140	3	●
AL-3RL-D16.0R4.0- AIR	16	4.0	16	15	16	84	140	3	●
AL-3RL-D20.0R1.0- AIR	20	1.0	20	19	20	89	140	3	●
AL-3RL- D20.0R2.0- AIR	20	2.0	20	19	20	89	140	3	○
AL-3RL- D20.0R3.0- AIR	20	3.0	20	19	20	89	140	3	○
AL-3RL-D20.0R4.0- AIR	20	4.0	20	19	20	89	140	3	○
AL-3RL- D20.0R5.0- AIR	20	5.0	20	19	20	89	140	3	○
AL-3RL- D20.0R6.0- AIR	20	6.0	20	19	20	89	140	3	○

for air space industry · für Luft- und Raumfahrt - Industrie

Material Overview · Material Übersicht

✓ = Very suitable · Sehr empfohlen
✓ = Suitable · Empfohlen

Workpiece material Werkstückstoff											
Carbon steel Kohlenstoff Stahl	Alloy steel Legierter Stahl	Quenched and tempered steel · Vergüteter Stahl		Hardened steel · Gehärteter Stahl		Stainless steel · Rostfreier Stahl	Cast iron, Nodular cast iron Grauguss GGG	Copper alloy Kupfer Leg	Aluminum alloy Alu Leg	Titanium alloy Titan Leg	Heat resist alloy warmfeste Leg
		~40HRC	~50HRC	~60HRC	~68HRC						
									✓		

● Ex Stock / ab Lager ○ On demand / auf Anfrage

YK 40F

Recommended cutting data · Empfohlene Schnittdaten

AL-3R-AIR

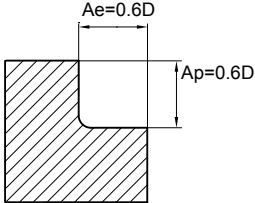
Workpiece material Werkstückstoff	Aluminum alloy Alu Legierungen		Silicon aluminium alloy Si≤10% Silizium Alu Legierungen Si≤10%	
Cutting speed Schnittgeschw.	800~1200m/min		800~1200m/min	
Diameter Ø Durchmesser (mm)	Rotating Drehzahl (min ⁻¹)	Feed Vorschub (mm/min)	Rotating Drehzahl (min ⁻¹)	Feed Vorschub (mm/min)
12	25000	6000	25000	6000
16	20000	6400	20000	6400
20	15000	7000	15000	7000
Max. cutting depth max Schnitttiefe	 <p>The diagram illustrates the maximum cutting parameters for a ball nose end mill. It shows a cross-section of the tool cutting into a workpiece. The axial cutting depth is labeled as $A_e = 0.6D$, and the radial cutting depth is labeled as $A_p = 0.6D$, where D is the diameter of the tool.</p>			

1. The cutting parameters above are applied for high speed machining Al alloy.
2. Please use cutting liquid or strong air blow to remove chips.
3. Sparks generated during machining process or heat caused by tool breakage may cause burning or fire. Please be careful of fireproof.
4. Dynamic balance test must be done before machining.

1. Obige Schnittdaten sind Hochgeschwindigkeits-Schnittdaten für die Bearbeitung von Alu Legierungen.
2. Bitte Kühlschmiermittel oder Luft mit hohem Druck zur Spanabfuhr benutzen.
3. Während der Bearbeitung können durch Funken Feuer entstehen. Bitte Vorkehrungen treffen.
4. Dynamische Auswuchtvorschriften beachten.

B

Solid Carbide end mills
Vollhartmetallschaftfräser

Milling · Fräsen

Solid Carbide end mills · Vollhartmetallschaftfräser

Recommended cutting data · Empfohlene Schnittdaten

AL-3RL-AIR

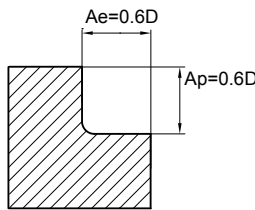
Workpiece material Werkstückstoff	Aluminum alloy Alu Legierungen		Silicon aluminium alloy Si≤10% Silizium Alu Legierungen Si≤10%	
Cutting speed Schnittgeschw.	800~1200m/min		800~1200m/min	
Diameter Ø Durchmesser (mm)	Rotating Drehzahl (min ⁻¹)	Feed Vorschub (mm/min)	Rotating Drehzahl (min ⁻¹)	Feed Vorschub (mm/min)
12	22000	5300	22000	5300
16	18000	5700	18000	5700
20	13000	6000	13000	6000
Max. cutting depth max Schnitttiefe	 <p>The diagram illustrates the maximum cutting parameters for a ball end mill. It shows a cross-section of the mill cutting into a workpiece. The maximum axial cutting depth is labeled as $A_e = 0.6D$, and the maximum radial cutting depth is labeled as $A_p = 0.6D$, where D is the diameter of the mill.</p>			

1. The cutting parameters above are applied for high speed machining Al alloy.
2. Please use cutting liquid or strong air blow to remove chips.
3. Sparks generated during machining process or heat caused by tool breakage may cause burning or fire. Please be careful of fireproof.
4. Dynamic balance test must be done before machining.

1. Obige Schnittdaten sind Hochgeschwindigkeits-Schnittdaten für die Bearbeitung von Alu Legierungen.
2. Bitte Kühlschmiermittel oder Luft mit hohem Druck zur Spanabfuhr benutzen.
3. Während der Bearbeitung können durch Funken Feuer entstehen. Bitte Vorkehrungen treffen.
4. Dynamische Auswuchtvorschriften beachten.

B

Solid Carbide end mills
Vollhartmetallschaftfräser

- Unique geometry design with unequal helix angle (38°/41°) in optimal combination of top grade, KMG 405.
- Suitable for roughing and finishing of steel, alloy steel and stainless steel, heat resistance super alloy.
- Effective milling with higher feed rate and bigger cutting depth.
- Quiet machining without vibration.
- Long tool life and good surface finishing.

- *Einzigartige Geometrie mit ungleichem Spiralwinkel (38°/41°), in Kombination mit der Hochleistungssorte KMG 405.*
- *Geeignet zur Schrapp- und Schlichtbearbeitung von Stahl, legiertem Stahl, rostfreiem Stahl.*
- *Effektive Fräsbearbeitung mit höheren Vorschüben und größeren Schnitttiefen.*
- *Ruhige Bearbeitung ohne Vibrationen.*
- *Höhere Standzeit und bessere Oberflächengüte.*



HPC Endmills

HPC Fräser

High Performance Solide Carbide Endmills
Hochleistungs-VHM-Fräser

HPC Endmills

HPC Fräser

UM Serie

- 1 Unique geometry design with different helix angle ($38^\circ/41^\circ$)
- 2 Optimal core structure for increasing the rigidity of the tools and optimized flute space
- 3 Individual cutting edge geometry for improved cutting edge stability
- 4 Universally applicable for machining of various materials with high cutting performance and a high surface quality.

- 1 Geometrie mit ungleichem Spiralwinkel ($38^\circ/41^\circ$)
- 2 Optimierte Kernstruktur für verbesserte Steifigkeit und Spanabfuhr des Werkzeugs
- 3 Unterschiedliche Schneidkanten Geometrie für verbesserte Stabilität der Schneidkanten
- 4 Universell einsetzbar für die Bearbeitung von unterschiedlichen Materialien mit hoher Zerspanungsleistung und einer hohen Oberflächengüte.

Material : 42CrMo(HRC35)
Material:

Square shoulder milling
Eckfräsen

Type : UM-4E-D10.0
Werkzeug:

$n=6000\text{r/min}$
 $fz=0.16\text{mm/z}$
 $ap=10\text{mm}$
 $ae=1\text{mm}$



Wear comparison
Verschleißvergleich

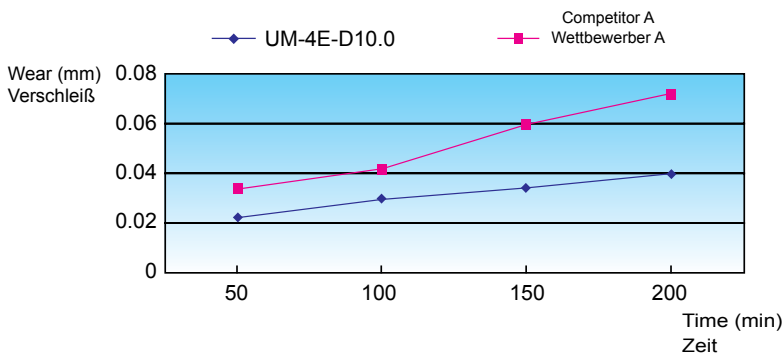

$\alpha_1 \neq \alpha_2$

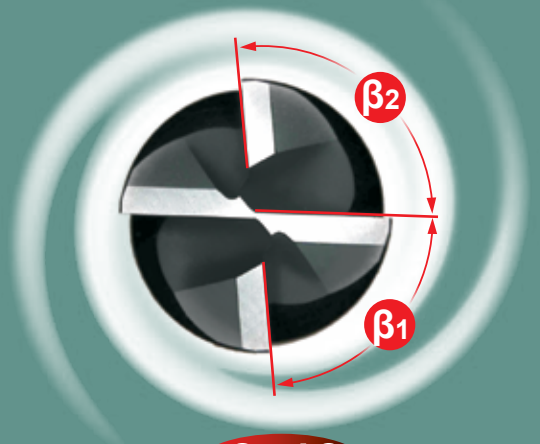

$\beta_1 \neq \beta_2$

Vibration Test / Vibrationsuntersuchung

Diameter / Durchmesser Ømm	Material	V _c m/min	f _z mm/z	a _p mm	a _e mm
6	1Cr18Ni9Ti	80	0,05	9	0,3

- Surface quality of the contour with the conventional end mills
- Oberflächengüte der Kontur mit herkömmlichem VHM-Fräser



- Surface quality of the contour with the ZCCCT HPC end mill
- Oberflächengüte der Kontur mit HPC VHM-Fräser von ZCCCT

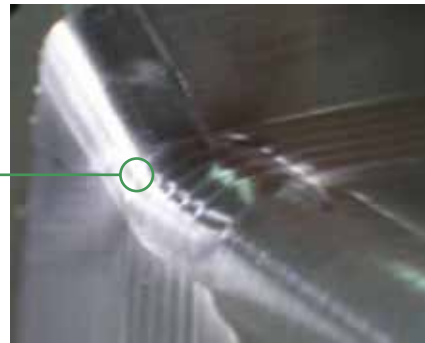

Tool Life / Standzeit (Machining time / Bearbeitungszeit: 180min.)

Diameter / Durchmesser Ømm	Material	V _c m/min	f _z mm/z	a _p mm	a _e mm
8	42CrMo HRC35	160	0,04	12	1,2

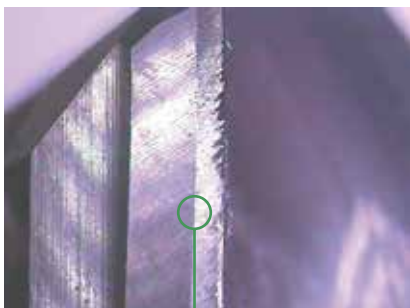

Company A / Wettbewerber A
HPC 35°/ 38°
V_{bmax} = 0,117mm

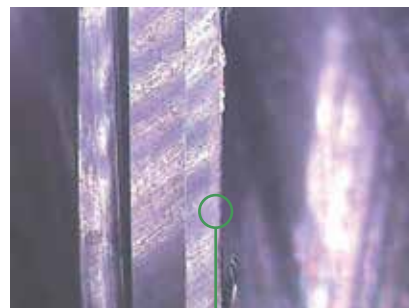

ZCCCT
HPC 38°/41°
V_{bmax}=0.072mm

Milling · Fräsen

Solid Carbide end mills · Vollhartmetallschaftfräser

Roughing / Schruppen



Workpiece	Werkstück	alloy steel leg. Stahl	alloy steel leg. Stahl	Ferritic stainless steel rostfreier Stahl	Ferritic stainless steel rostfreier Stahl
Material	Werkstoff	1.2714 steel	1.2714 steel	1.4313 X5CrNi134	1.4301 X5CrNi189
Hardness	Härte				
Tensile Strength	Zugfestigkeit N/mm ²	1400	1400		
Cutting tools	Werkzeug				
Teeth Z	Zähnezahl Z	4	4	4	4
Producer/Supplier	Hersteller (Werkzeug)	ZCCCT	ZCCCT	ZCCCT	ZCCCT
Grade	Schneidstoff Sorte	KMG405	KMG405	KMG405	KMG405
Solid carbide tools art no.	Vollhartmetallwerkzeug Nr.	D8, λ=38/41	D12, λ=38/41	D12, λ=38/41	D12, λ=38/41
Cutting condition	Schnittdaten				
RPM n=r/min	Drehzahl n=U/min	5971	3980	4775	4775
Cutting speed Vc=m/min	Schnittgeschw. Vc=m/min	150	150	180	180
Feed rate f=mm/r	Vorschub f=mm/U	fz=0.05	fz=0.075	0.15	0.15
Depth of cut ap mm	Schnitttiefe ap mm	8	12	25	25
Depth of cut ae mm	Schnittbreite ae mm	3,6	5,4	1,5	1,5

● Ex Stock / ab Lager ○ On demand / auf Anfrage

5501R38414GM

4-flute end mills
4-Schneiden VHM Schaftfräser

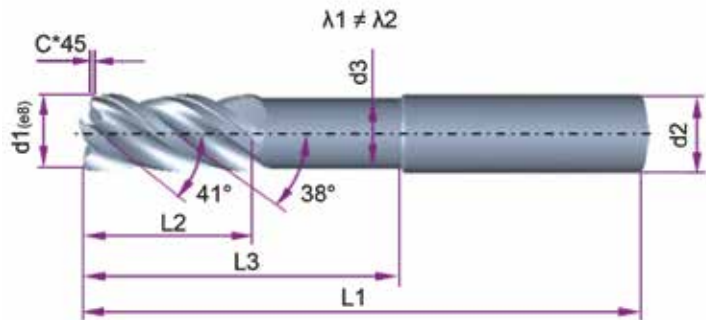
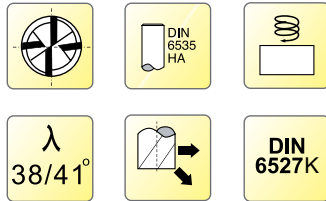

Type Typ	Dimension(mm) Abmessungen							Teeth Zähne	Application Anwendung	Grade Sorte	P M K
	d1(e8)	d2(h6)	L1	L2	d3	L3	C*45°				
5501R38414GM-0400	4	6	54	8	3.70	16	0.01-0.06	4			●
5501R38414GM-0500	5	6	54	9	4.70	17	0.01-0.06	4			●
5501R38414GM-0600	6	6	54	10	5.70	18	0.06-0.10	4			●
5501R38414GM-0800	8	8	58	12	7.70	22	0.06-0.10	4			●
5501R38414GM-1000	10	10	66	14	9.50	26	0.06-0.10	4			●
5501R38414GM-1200	12	12	73	16	11.50	28	0.10-0.15	4			●
5501R38414GM-1400	14	14	75	18	13.50	30	0.10-0.15	4			●
5501R38414GM-1600	16	16	82	22	15.50	34	0.10-0.15	4			●
5501R38414GM-1800	18	18	84	24	17.50	36	0.10-0.15	4			●
5501R38414GM-2000	20	20	92	26	19.50	42	0.15-0.20	4			●

B

Solid Carbide end mills
Vollhartmetallschaftfräser

Material Overview · Material Übersicht

✓ = Very suitable · Sehr empfohlen
✓ = Suitable · Empfohlen

KMG405	Workpiece material Werkstückstoff											
	Carbon steel Kohlenstoff Stahl	Alloy steel Legierter Stahl	Quenched and tempered steel · Vergüteter Stahl		Hardened steel · Gehärteter Stahl		Stainless steel · Rostfreier Stahl	Cast iron, Nodular cast iron Grauguss GGG	Copper alloy Kupfer Leg	Aluminum alloy Alu Leg	Titanium alloy Titan Leg	Heat resist alloy warmfeste Leg
			~40HRC	~50HRC	~60HRC	~68HRC						
✓	✓	✓	✓			✓	✓			✓	✓	

Code key [B252,B254](#)
ISO Kennzeichen

Cutting data [B506-B507](#)
Schnittdaten

Graphics identification & application [B253,B255](#)
Graphische Werkzeug- & Anwendungsbeschr.

Order form for non-standard products [B534-B535](#)
Bestellformular für Sonderwerkzeuge

Milling · Fräsen

Solid Carbide end mills · Vollhartmetallschaftfräser

5502R38414GM

4-flute end mills
4-Schneiden VHM Schaftfräser

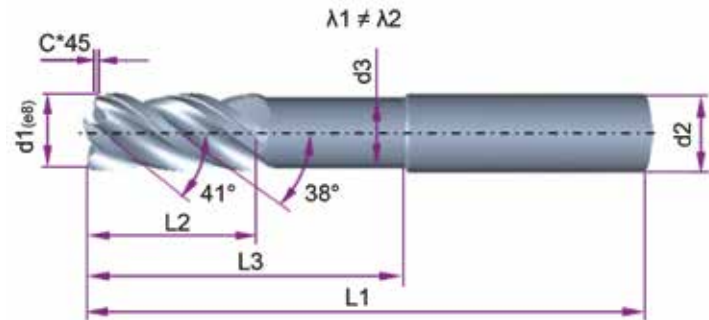
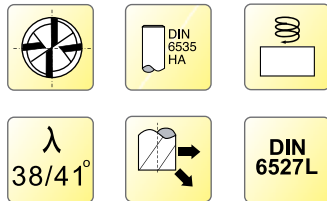
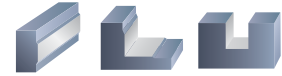

Type Typ	Dimension(mm) Abmessungen							Teeth Zähne	Applicaion Anwendung	P M K		
	d1(e8)	d2(h6)	L1	L2	d3	L3	C*45°			Grade Sorte	KMG 405	
5502R38414GM-0400	4	6	57	11	3.70	19	0.01-0.06	4			●	
5502R38414GM-0500	5	6	57	13	4.70	21	0.01-0.06	4			●	
5502R38414GM-0600	6	6	57	13	5.70	21	0.06-0.10	4			●	
5502R38414GM-0800	8	8	63	19	7.70	27	0.06-0.10	4			●	
5502R38414GM-1000	10	10	72	22	9.50	32	0.06-0.10	4			●	
5502R38414GM-1200	12	12	83	26	11.50	38	0.10-0.15	4			●	
5502R38414GM-1400	14	14	83	26	13.50	38	0.10-0.15	4			●	
5502R38414GM-1600	16	16	92	32	15.50	44	0.10-0.15	4			●	
5502R38414GM-1800	18	18	92	32	17.50	44	0.10-0.15	4			●	
5502R38414GM-2000	20	20	104	38	19.50	54	0.15-0.20	4			●	

Material Overview · Material Übersicht

✓ = Very suitable · Sehr empfohlen
✓ = Suitable · Empfohlen

KMG405

Workpiece material Werkstückstoff											
Carbon steel Kohlenstoff Stahl	Alloy steel Legierter Stahl	Quenched and tempered steel · Vergüteter Stahl		Hardened steel · Gehärteter Stahl		Stainless steel · Rostfreier Stahl	Cast iron, Nodular cast iron Grauguss GGG	Copper alloy Kupfer Leg	Aluminum alloy Alu Leg	Titanium alloy Titan Leg	Heat resist alloy warmfeste Leg
		~40HRC	~50HRC	~60HRC	~68HRC						
✓	✓	✓	✓			✓	✓			✓	✓

● Ex Stock / ab Lager ○ On demand / auf Anfrage

5602R38414GM

4-flute end mills
4-Schneiden VHM Schaftfräser

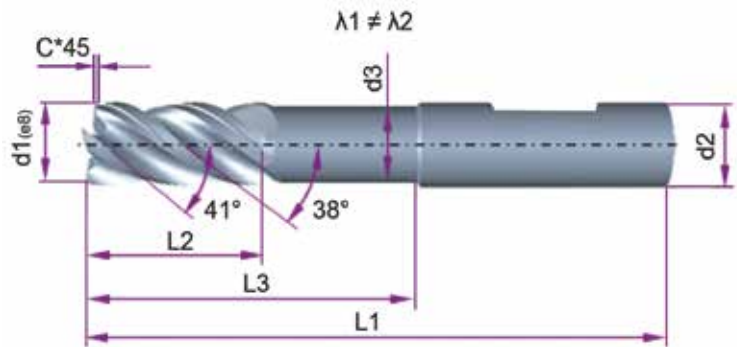
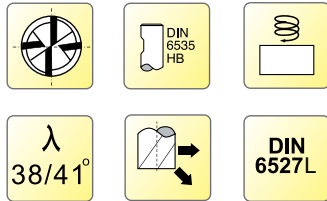

Type Typ	Dimension(mm) Abmessungen							Teeth Zähne	Application Anwendung	P	M	K
	d1(e8)	d2(h6)	L1	L2	d3	L3	C*45°	Z	Grade Sorte	KMG 405		
5602R38414GM-0400	4	6	57	11	3.70	19	0.01-0.06	4			●	
5602R38414GM-0500	5	6	57	13	4.70	21	0.01-0.06	4			●	
5602R38414GM-0600	6	6	57	13	5.70	21	0.06-0.10	4			●	
5602R38414GM-0800	8	8	63	19	7.70	27	0.06-0.10	4			●	
5602R38414GM-1000	10	10	72	22	9.50	32	0.06-0.10	4			●	
5602R38414GM-1200	12	12	83	26	11.50	38	0.10-0.15	4			●	
5602R38414GM-1400	14	14	83	26	13.50	38	0.10-0.15	4			●	
5602R38414GM-1600	16	16	92	32	15.50	44	0.10-0.15	4			●	
5602R38414GM-1800	18	18	92	32	17.50	44	0.10-0.15	4			●	
5602R38414GM-2000	20	20	104	38	19.50	54	0.15-0.20	4			●	

B

Solid Carbide end mills
Vollhartmetallschaftfräser

Material Overview · Material Übersicht

✓ = Very suitable · Sehr empfohlen
✓ = Suitable · Empfohlen

Carbon steel Kohlenstoff Stahl	Alloy steel Legierter Stahl	Quenched and tempered steel · Vergüteter Stahl		Hardened steel · Gehärteter Stahl		Stainless steel · Rostfreier Stahl	Cast iron, Nodular cast iron Grauguss GGG	Copper alloy Kupfer Leg	Aluminum alloy Alu Leg	Titanium alloy Titan Leg	Heat resist alloy warmfeste Leg
		~40HRC	~50HRC	~60HRC	~68HRC						
✓	✓	✓	✓			✓	✓			✓	✓

KMG405

Code key [B252,B254](#)
ISO Kennzeichen

Cutting data [B506-B507](#)
Schnittdaten

Graphics identification & application [B253,B255](#)
Graphische Werkzeug- & Anwendungsbeschr.

Order form for non-standard products [B534-B535](#)
Bestellformular für Sonderwerkzeuge

B 503

Milling · Fräsen

Solid Carbide end mills · Vollhartmetallschaftfräser

5502R38414GM-R

4-flute end mills with radius
4-Schneiden VHM Schaftfräser mit Radius

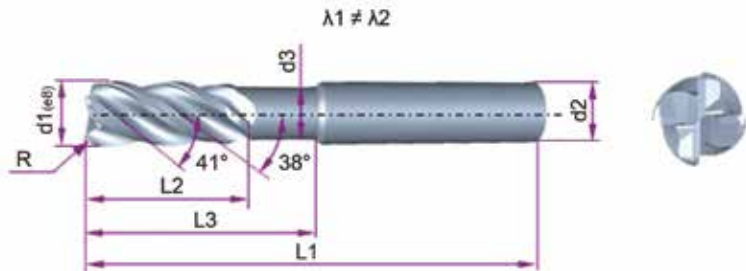
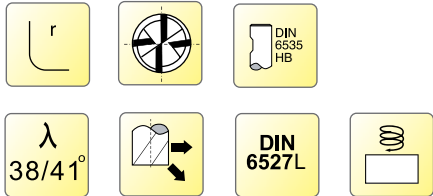

Type Typ	Dimension(mm) Abmessungen							Teeth Zähne Z	Application Anwendung Grade Sorte	P M K
	d1(e8)	R±0.01	d2(h6)	L1	L2	d3	L3			
5502R38414GM-R02-0400	4	0.2	6	57	11	3.70	19	4		●
5502R38414GM-R05-0400	4	0.5	6	57	11	3.70	19	4		●
5502R38414GM-R02-0500	5	0.2	6	57	13	4.70	21	4		●
5502R38414GM-R05-0500	5	0.5	6	57	13	4.70	21	4		●
5502R38414GM-R02-0600	6	0.2	6	57	13	5.70	21	4		●
5502R38414GM-R05-0600	6	0.5	6	57	13	5.70	21	4		●
5502R38414GM-R10-0600	6	1.0	6	57	13	5.70	21	4		●
5502R38414GM-R02-0800	8	0.2	8	63	19	7.70	27	4		●
5502R38414GM-R05-0800	8	0.5	8	63	19	7.70	27	4		●
5502R38414GM-R10-0800	8	1.0	8	63	19	7.70	27	4		●
5502R38414GM-R15-0800	8	1.5	8	63	19	7.70	27	4		●
5502R38414GM-R20-0800	8	2.0	8	63	19	7.70	27	4		●
5502R38414GM-R02-1000	10	0.2	10	72	22	9.50	32	4		●
5502R38414GM-R05-1000	10	0.5	10	72	22	9.50	32	4		●
5502R38414GM-R10-1000	10	1.0	10	72	22	9.50	32	4		●
5502R38414GM-R15-1000	10	1.5	10	72	22	9.50	32	4		●
5502R38414GM-R20-1000	10	2.0	10	72	22	9.50	32	4		●
5502R38414GM-R05-1200	12	0.5	12	83	26	11.50	38	4		●
5502R38414GM-R10-1200	12	1.0	12	83	26	11.50	38	4		●
5502R38414GM-R15-1200	12	1.5	12	83	26	11.50	38	4		●
5502R38414GM-R20-1200	12	2.0	12	83	26	11.50	38	4		●
5502R38414GM-R10-1600	16	1.0	16	92	32	15.50	44	4		●
5502R38414GM-R15-1600	16	1.5	16	92	32	15.50	44	4		●
5502R38414GM-R20-1600	16	2.0	16	92	32	15.50	44	4		●
5502R38414GM-R30-1600	16	3.0	16	92	32	15.50	44	4		●
5502R38414GM-R10-2000	20	1.0	20	104	38	19.50	54	4		●
5502R38414GM-R15-2000	20	1.5	20	104	38	19.50	54	4		●
5502R38414GM-R20-2000	20	2.0	20	104	38	19.50	54	4		●
5502R38414GM-R30-2000	20	3.0	20	104	38	19.50	54	4		●

Material Overview · Material Übersicht

✓ = Very suitable · Sehr empfohlen
✓ = Suitable · Empfohlen

KMG405

Workpiece material Werkstückstoff											
Carbon steel Kohlenstoff Stahl	Alloy steel Legierter Stahl	Quenched and tempered steel · Vergüteter Stahl		Hardened steel · Gehärteter Stahl		Stainless steel · Rostfreier Stahl	Cast iron, Nodular cast iron Grauguss GGG	Copper alloy Kupfer Leg	Aluminum alloy Alu Leg	Titanium alloy Titan Leg	Heat resist alloy warmfeste Leg
		~40HRC	~50HRC	~60HRC	~68HRC						
✓	✓	✓	✓			✓	✓			✓	✓

● Ex Stock / ab Lager ○ On demand / auf Anfrage

5602R38414GM-R

4-flute end mills with radius
4-Schneiden VHM Schafffräser mit Radius

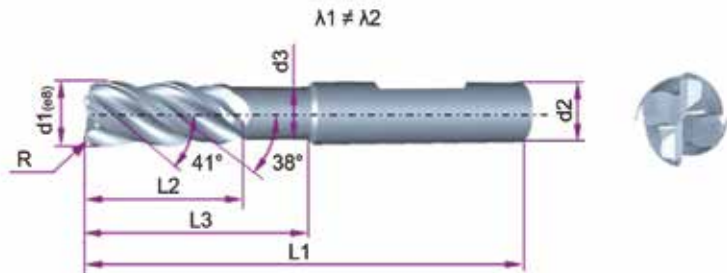
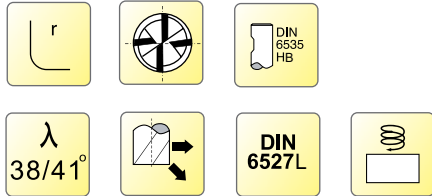

Type Typ	Dimension(mm) Abmessungen							Teeth Zähne Z	Application Anwendung Grade Sorte	P M K
	d1(e8)	R±0.01	d2(h6)	L1	L2	d3	L3			
5602R38414GM-R02-0400	4	0.2	6	57	11	3.70	19	4		•
5602R38414GM-R05-0400	4	0.5	6	57	11	3.70	19	4		•
5602R38414GM-R02-0500	5	0.2	6	57	13	4.70	21	4		•
5602R38414GM-R05-0500	5	0.5	6	57	13	4.70	21	4		•
5602R38414GM-R02-0600	6	0.2	6	57	13	5.70	21	4		•
5602R38414GM-R05-0600	6	0.5	6	57	13	5.70	21	4		•
5602R38414GM-R10-0600	6	1.0	6	57	13	5.70	21	4		•
5602R38414GM-R02-0800	8	0.2	8	63	19	7.70	27	4		•
5602R38414GM-R05-0800	8	0.5	8	63	19	7.70	27	4		•
5602R38414GM-R10-0800	8	1.0	8	63	19	7.70	27	4		•
5602R38414GM-R15-0800	8	1.5	8	63	19	7.70	27	4		•
5602R38414GM-R20-0800	8	2.0	8	63	19	7.70	27	4		•
5602R38414GM-R02-1000	10	0.2	10	72	22	9.50	32	4		•
5602R38414GM-R05-1000	10	0.5	10	72	22	9.50	32	4		•
5602R38414GM-R10-1000	10	1.0	10	72	22	9.50	32	4		•
5602R38414GM-R15-1000	10	1.5	10	72	22	9.50	32	4		•
5602R38414GM-R20-1000	10	2.0	10	72	22	9.50	32	4		•
5602R38414GM-R05-1200	12	0.5	12	83	26	11.50	38	4		•
5602R38414GM-R10-1200	12	1.0	12	83	26	11.50	38	4		•
5602R38414GM-R15-1200	12	1.5	12	83	26	11.50	38	4		•
5602R38414GM-R20-1200	12	2.0	12	83	26	11.50	38	4		•
5602R38414GM-R10-1600	16	1.0	16	92	32	15.50	44	4		•
5602R38414GM-R15-1600	16	1.5	16	92	32	15.50	44	4		•
5602R38414GM-R20-1600	16	2.0	16	92	32	15.50	44	4		•
5602R38414GM-R30-1600	16	3.0	16	92	32	15.50	44	4		•
5602R38414GM-R10-2000	20	1.0	20	104	38	19.50	54	4		•
5602R38414GM-R15-2000	20	1.5	20	104	38	19.50	54	4		•
5602R38414GM-R20-2000	20	2.0	20	104	38	19.50	54	4		•
5602R38414GM-R30-2000	20	3.0	20	104	38	19.50	54	4		•

B

Solid Carbide end mills
Vollhartmetallschaftfräser

Material Overview · Material Übersicht

✓ = Very suitable · Sehr empfohlen
✓ = Suitable · Empfohlen

Workpiece material Werkstückstoff											
Carbon steel Kohlenstoff Stahl	Alloy steel Legierter Stahl	Quenched and tempered steel · Vergüteter Stahl		Hardened steel · Gehärteter Stahl		Stainless steel · Rostfreier Stahl	Cast iron, Nodular cast iron Grauguss GGG	Copper alloy Kupfer Leg	Aluminum alloy Alu Leg	Titanium alloy Titan Leg	Heat resist alloy warmfeste Leg
		~40HRC	~50HRC	~60HRC	~68HRC						
✓	✓	✓	✓			✓	✓			✓	✓

KMG405

Code key **B252,B254**
ISO Kennzeichen

Cutting data **B506-B507**
Schnittdaten

Graphics identification & application **B253,B255**
Graphische Werkzeug- & Anwendungsbeschr.

Order form for non-standard products **B534-B535**
Bestellformular für Sonderwerkzeuge

Milling - Fräsen

Solid Carbide end mills - Vollhartmetallschaftfräser

Recommended cutting data - Empfohlene Schnittdaten

5501R38414GM | 5502R38414GM(-R) | 5602R38414GM(-R)

Workpiece material Werkstückmaterial	Carbon steel, Alloy steel Kohlenstoffstahl Leg. Stahl ~30HRC		Alloy steel, Tool steel, Pre-hardened steel Leg. Stahl, Vergüteter Stahl 30 ~ 45HRC		Austenitic Stainless steel, Titanium alloy Austenitischer rostfreier Stahl, Titan-Legier.		hardened steel Gehärteter Stahl 45 ~ 55 HRC		Heat resist. super alloy Warmfeste Superlegierung.	
	Diameter Ø Durchmesser (mm)	Rotating Drehzahl (min ⁻¹)	Feed Vorschub (mm/min)	Rotating Drehzahl (min ⁻¹)	Feed Vorschub (mm/min)	Rotating Drehzahl (min ⁻¹)	Feed Vorschub (mm/min)	Rotating Drehzahl (min ⁻¹)	Feed Vorschub (mm/min)	Rotating Drehzahl (min ⁻¹)
4	10000	1800	10000	1800	6800	1080	4800	384	2800	224
5	8000	1760	8000	1760	5500	1100	3800	380	2200	220
6	7000	1960	7000	1960	4600	1120	3200	384	1900	228
8	5000	1400	5000	1400	3400	800	2400	384	1400	168
10	4000	1200	4000	1200	2700	680	1900	380	1100	144
12	3500	1040	3500	1040	2300	640	1600	320	900	136
14	3000	1020	3000	1020	2000	560	1400	308	800	120
16	2600	920	2600	920	1700	480	1200	288	700	116
18	2300	840	2300	840	1500	420	1100	308	620	100
20	2100	760	2100	760	1400	440	1000	320	560	96

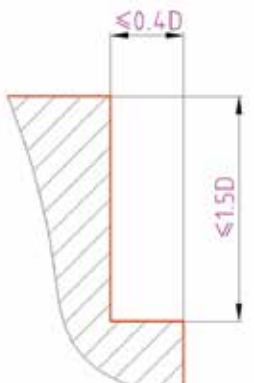
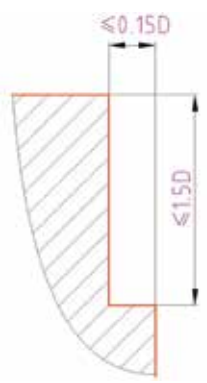
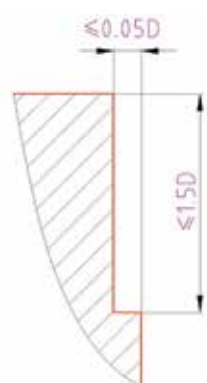
Max. cutting depth max. Schnitttiefe			
---	---	---	---

- The above table shows the standard value of side milling.
- Please select high precise machine and tool holder.
- Please use air blow or cutting liquid with high mist retardant property.
- Down milling is recommended in side milling.
- Vibration and unusual noise may be generated if the machine rigidity and workpiece fixture stability is low, please reduce the rotating speed and feed rate like mentioned above.
- Make overhang as short as possible if no interference.

- Die obige Tabelle zeigt Standard Werte für das Eckfräsen.
- Bitte präzise Maschinen und Werkzeughalter verwenden.
- Bitte Luftkühlung oder Schneidflüssigkeit benutzen.
- Empfohlene Fräsmethode: Gleichlaufräsen.
- Bei Vibrationen oder ungewöhnlichen Geräuschen reduzieren Sie die Schnittdaten (wie oben empfohlen) entsprechend.
- Werkzeugauskragung so kurz wie möglich wählen.

Recommended cutting data · Empfohlene Schnittdaten

5501R38414GM | 5502R38414GM(-R) | 5602R38414GM (-R)

Workpiece material Werkstückmaterial	Carbon steel, Alloy steel Kohlenstoffstahl Leg. Stahl ~30HRC		Alloy steel, Tool steel, Pre-hardened steel Leg. Stahl, Vergüteter Stahl 30 ~ 45HRC		Austenitic Stainless steel, Titanium alloy Austenitischer rostfreier Stahl, Titan-Legier.		hardened steel Gehärteter Stahl 45 ~ 55 HRC		Heat resist. super alloy Warmfeste Superlegierung	
	Diameter Ø Durchmesser (mm)	Rotating Drehzahl (min ⁻¹)	Feed Vorschub (mm/min)	Rotating Drehzahl (min ⁻¹)	Feed Vorschub (mm/min)	Rotating Drehzahl (min ⁻¹)	Feed Vorschub (mm/min)	Rotating Drehzahl (min ⁻¹)	Feed Vorschub (mm/min)	Rotating Drehzahl (min ⁻¹)
4	8400	1000	4800	480	4800	480	2100	160	2100	160
5	6700	1080	3800	480	3800	480	1700	140	1700	140
6	5600	1120	3200	520	3200	520	1400	140	1400	140
8	4200	1000	2400	480	2400	480	1000	120	1000	120
10	3300	800	1900	400	1900	400	800	120	800	120
12	2800	720	1600	360	1600	360	700	120	700	120
14	2400	640	1400	320	1400	320	600	96	600	96
16	2100	600	1200	280	1200	280	500	80	500	80
18	1900	520	1100	280	1100	280	500	80	500	80
20	1700	560	1000	240	1000	240	400	80	400	80

Max. cutting depth max Schnitttiefe			
--	--	--	--

1. The above table shows the standard value of slot milling..
2. Please select high precise machine and tool holder.
3. Please use air blow or cutting liquid with high mist retardant property.
4. Down milling is recommended in side milling.
5. Vibration and unusual noise may be generated if the machine rigidity and workpiece fixture stability is low, please reduce the rotating speed and feed rate like mentioned above.
6. Make overhang as short as possible if no interference.

1. Die obige Tabelle zeigt Standard Werte für das Nutenfräsen.
2. Bitte präzise Maschinen und Werkzeughalter verwenden.
3. Bitte Luftkühlung oder Schneidflüssigkeit benutzen.
4. Empfohlene Fräsmethode: Gleichlaufräsen.
5. Bei Vibrationen oder unüblichen Geräuschen reduzieren Sie die Schnittdaten (wie oben empfohlen) entsprechend.
6. Werkzeugauskragung so kurz wie möglich wählen.

Milling · Fräsen

Solid Carbide end mills · Vollhartmetallschaftfräser

4-flute flattened end mills with straight shank 4-Schneiden Eckfräser mit Zylinderschaft



UM-4E

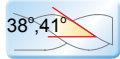
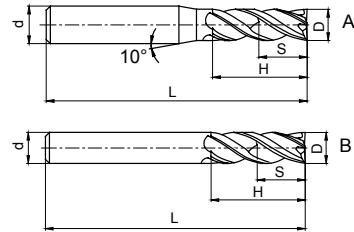

$\frac{D}{d}$	D ≤ 6 -0.020~-0.038	6 < D ≤ 10 -0.025~-0.047
	10 < D ≤ 18 -0.032~-0.059	18 < D -0.04~-0.073



Type Typ	Dimension(mm) Abmessungen					Teeth Zähne Z	Geometry Ausführung	Stock Lager
	D	d	H	S	L			
UM-4E-D4.0S	4.0	4	11	6.00	50	4	B	●
UM-4E-D4.0	4.0	6	11	6.00	50	4	A	●
UM-4E-D4.5	4.5	6	11	6.75	50	4	A	●
UM-4E-D5.0	5.0	6	13	7.50	50	4	A	●
UM-4E-D5.5	5.5	6	16	8.25	50	4	A	●
UM-4E-D6.0	6.0	6	16	9.00	50	4	B	●
UM-4E-D7.0	7.0	8	20	10.5	60	4	A	●
UM-4E-D8.0	8.0	8	20	12.0	60	4	B	●
UM-4E-D9.0	9.0	10	22	13.5	75	4	A	●
UM-4E-D10.0	10.0	10	25	15.0	75	4	B	●
UM-4E-D11.0	11.0	12	26	16.5	75	4	A	●
UM-4E-D12.0	12.0	12	30	18.0	75	4	B	●
UM-4E-D14.0	14.0	14	32	21.0	75	4	B	●
UM-4E-D16.0	16.0	16	45	24.0	100	4	B	●
UM-4E-D18.0	18.0	18	45	27.0	100	4	B	●
UM-4E-D20.0	20.0	20	45	30.0	100	4	B	●

B

Solid Carbide end mills
Vollhartmetallschaftfräser

Material Overview · Material Übersicht

✓ = Very suitable · Sehr empfohlen
✓ = Suitable · Empfohlen

Workpiece material Werkstückstoff											
Carbon steel Kohlenstoff Stahl	Alloy steel Legierter Stahl	Quenched and tempered steel · Vergüteter Stahl		Hardened steel · Gehärteter Stahl		Stainless steel · Rostfreier Stahl	Cast iron, Nodular cast iron Grauguss GGG	Copper alloy Kupfer Leg	Aluminum alloy Alu Leg	Titanium alloy Titan Leg	Heat resist alloy warmfeste Leg
		~40HRC	~50HRC	~55HRC	~68HRC						
✓	✓	✓	✓	✓		✓	✓			✓	✓

● Ex Stock / ab Lager ○ On demand / auf Anfrage

4-flute flattened end mills with straight shank 4-Schneiden Eckfräser mit Zylinderschaft



UM-4E-W

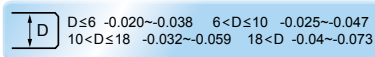
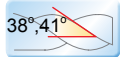
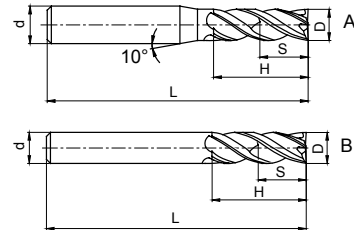

Type Typ	Dimension(mm) Abmessungen					Teeth Zähne Z	Geometry Ausführung	Stock Lager
	D	d	H	S	L			
UM-4E-D4.0S-W	4.0	4	11	6.00	50	4	B	•
UM-4E-D4.0-W	4.0	6	11	6.00	50	4	A	•
UM-4E-D4.5-W	4.5	6	11	6.75	50	4	A	•
UM-4E-D5.0-W	5.0	6	13	7.50	50	4	A	•
UM-4E-D5.5-W	5.5	6	16	8.25	50	4	A	•
UM-4E-D6.0-W	6.0	6	16	9.00	50	4	B	•
UM-4E-D7.0-W	7.0	8	20	10.5	60	4	A	•
UM-4E-D8.0-W	8.0	8	20	12.0	60	4	B	•
UM-4E-D9.0-W	9.0	10	22	13.5	75	4	A	•
UM-4E-D10.0-W	10.0	10	25	15.0	75	4	B	•
UM-4E-D11.0-W	11.0	12	26	16.5	75	4	A	•
UM-4E-D12.0-W	12.0	12	30	18.0	75	4	B	•
UM-4E-D14.0-W	14.0	14	32	21.0	75	4	B	•
UM-4E-D16.0-W	16.0	16	45	24.0	100	4	B	•
UM-4E-D18.0-W	18.0	18	45	27.0	100	4	B	•
UM-4E-D20.0-W	20.0	20	45	30.0	100	4	B	•

B

Solid Carbide end mills
Vollhartmetallschaftfräser

Material Overview · Material Übersicht

✓ = Very suitable · Sehr empfohlen
✓ = Suitable · Empfohlen

Workpiece material Werkstückstoff											
Carbon steel Kohlenstoff Stahl	Alloy steel Legierter Stahl	Quenched and tempered steel · Vergüteter Stahl		Hardened steel · Gehärteter Stahl		Stainless steel · Rostfreier Stahl	Cast iron, Nodular cast iron Grauguss GGG	Copper alloy Kupfer Leg	Aluminum alloy Alu Leg	Titanium alloy Titan Leg	Heat resist alloy warmfeste Leg
		~40HRC	~50HRC	~55HRC	~68HRC						
✓	✓	✓	✓	✓		✓	✓			✓	✓

Code key **B252,B254**
ISO Kennzeichen

Cutting data **B514-B517**
Schnittdaten

Graphics identification & application **B253,B255**
Graphische Werkzeug- & Anwendungsbeschr.

Order form for non-standard products **B534-B535**
Bestellformular für Sonderwerkzeuge

Milling · Fräsen

Solid Carbide end mills · Vollhartmetallschaftfräser

4-flute flattened end mills with straight shank and long cutting edge
4-Schneiden Eckfräser mit langer Schneide und Zylinderschaft



UM-4EL

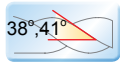
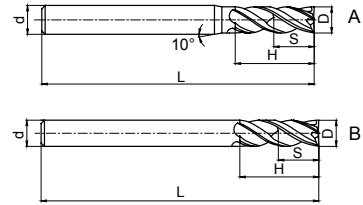

D	D ≤ 6	-0.020 ~ -0.038	6 < D ≤ 10	-0.025 ~ -0.047
	10 < D ≤ 18	-0.032 ~ -0.059	18 < D	-0.04 ~ -0.073



Type Typ	Dimension (mm) Abmessungen					Teeth Zähne Z	Geometry Ausführung	Stock Lager
	D	d	H	S	L			
UM-4EL-D4.0	4.0	6	15	6.00	75	4	A	●
UM-4EL-D5.0	5.0	6	20	7.50	75	4	A	●
UM-4EL-D6.0	6.0	6	20	9.00	75	4	B	●
UM-4EL-D8.0	8.0	8	25	12.0	100	4	B	●
UM-4EL-D10.0	10.0	10	30	15.0	100	4	B	●
UM-4EL-D12.0	12.0	12	35	18.0	100	4	B	●
UM-4EL-D14.0	14.0	14	40	21.0	100	4	B	●
UM-4EL-D16.0	16.0	16	50	24.0	150	4	B	●
UM-4EL-D20.0	20.0	20	55	30.0	150	4	B	●

B

Solid Carbide end mills
Vollhartmetallschaftfräser

Material Overview · Material Übersicht

✓ = Very suitable · Sehr empfohlen
✓ = Suitable · Empfohlen

Workpiece material Werkstückstoff											
Carbon steel Kohlenstoff Stahl	Alloy steel Legierter Stahl	Quenched and tempered steel · Vergüteter Stahl		Hardened steel · Gehärteter Stahl		Stainless steel · Rostfreier Stahl	Cast iron, Nodular cast iron Grauguss GGG	Copper alloy Kupfer Leg	Aluminum alloy Alu Leg	Titanium alloy Titan Leg	Heat resist alloy warmfeste Leg
		~40HRC	~50HRC	~55HRC	~68HRC						
✓	✓	✓	✓	✓		✓	✓			✓	✓

● Ex Stock / ab Lager ○ On demand / auf Anfrage

4-flute flattened end mills with straight shank and long cutting edge
4-Schneiden Eckfräser mit langer Schneide und Zylinderschaft



UM-4EL-W

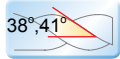
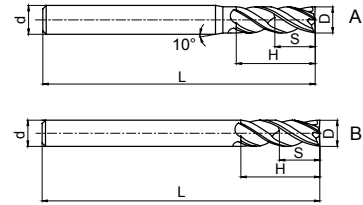

D	D ≤ 6	-0.020 ~ -0.038	6 < D ≤ 10	-0.025 ~ -0.047
	10 < D ≤ 18	-0.032 ~ -0.059	18 < D	-0.04 ~ -0.073



Type Typ	Dimension (mm) Abmessungen					Teeth Zähne Z	Geometry Ausführung	Stock Lager
	D	d	H	S	L			
UM-4EL-D4.0-W	4.0	6	15	6.00	75	4	A	●
UM-4EL-D5.0-W	5.0	6	20	7.50	75	4	A	●
UM-4EL-D6.0-W	6.0	6	20	9.00	75	4	B	●
UM-4EL-D8.0-W	8.0	8	25	12.0	100	4	B	●
UM-4EL-D10.0-W	10.0	10	30	15.0	100	4	B	●
UM-4EL-D12.0-W	12.0	12	35	18.0	100	4	B	●
UM-4EL-D14.0-W	14.0	14	40	21.0	100	4	B	●
UM-4EL-D16.0-W	16.0	16	50	24.0	150	4	B	●
UM-4EL-D20.0-W	20.0	20	55	30.0	150	4	B	●

B

Solid Carbide end mills
Vollhartmetallschaftfräser

Material Overview · Material Übersicht

✓ = Very suitable · Sehr empfohlen
✓ = Suitable · Empfohlen

Workpiece material Werkstückstoff											
Carbon steel Kohlenstoff Stahl	Alloy steel Legierter Stahl	Quenched and tempered steel · Vergüteter Stahl		Hardened steel · Gehärteter Stahl		Stainless steel · Rostfreier Stahl	Cast iron, Nodular cast iron Grauguss GGG	Copper alloy Kupfer Leg	Aluminum alloy Alu Leg	Titanium alloy Titan Leg	Heat resist alloy warmfeste Leg
		~40HRC	~50HRC	~55HRC	~68HRC						
✓	✓	✓	✓	✓		✓	✓			✓	✓

Code key **B252, B254**
ISO Kennzeichen

Cutting data **B514-B517**
Schnittdaten

Graphics identification & application **B253, B255**
Graphische Werkzeug- & Anwendungsbeschr.

Order form for non-standard products **B534-B535**
Bestellformular für Sonderwerkzeuge

Milling · Fräsen

Solid Carbide end mills · Vollhartmetallschaftfräser

4-flute flattened end mills with straight shank and long cutting edge
4-Schneiden Eckfräser mit langer Schneide und Zylinderschaft



UM-4ELP-W

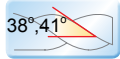
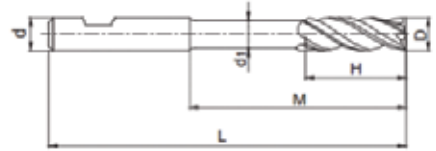

D ≤ 6 -0.020~-0.038 6 < D ≤ 10 -0.025~-0.047
10 < D ≤ 18 -0.032~-0.059 18 < D -0.04~-0.073



Type Typ	Dimension(mm) Abmessungen						Teeth Zähne Z	Stock Lager
	D	M	d1	H	L	d		
UM-4ELP-D4.0-W	4.0	36	3,8	15	75	6	4	●
UM-4ELP-D5.0-W	5.0	36	4,8	20	75	6	4	●
UM-4ELP-D6.0-W	6.0	36	5,7	20	75	6	4	●
UM-4ELP-D8.0-W	8.0	60	7,7	25	100	8	4	●
UM-4ELP-D10.0-W	10.0	55	9,5	30	100	10	4	●
UM-4ELP-D12.0-W	12.0	50	11,5	35	100	12	4	●
UM-4ELP-D14.0-W	14.0	50	13,5	40	100	14	4	●
UM-4ELP-D16.0-W	16.0	100	15,5	50	150	16	4	●
UM-4ELP-D20.0-W	20.0	98	19,5	55	150	20	4	●

B

Solid Carbide end mills
Vollhartmetallschaftfräser

Material Overview · Material Übersicht

✓ = Very suitable · Sehr empfohlen
✓ = Suitable · Empfohlen

Workpiece material Werkstückstoff											
Carbon steel Kohlenstoff Stahl	Alloy steel Legierter Stahl	Quenched and tempered steel · Vergüteter Stahl		Hardened steel · Gehärteter Stahl		Stainless steel · Rostfreier Stahl	Cast iron, Nodular cast iron Grauguss GGG	Copper alloy Kupfer Leg	Aluminum alloy Alu Leg	Titanium alloy Titan Leg	Heat resist alloy warmfeste Leg
		~40HRC	~50HRC	~55HRC	~68HRC						
✓	✓	✓	✓	✓		✓	✓			✓	✓

● Ex Stock / ab Lager ○ On demand / auf Anfrage

4-flute flattened end mills with short cutting edge and long neck 4-Schneiden Eckfräser mit kurzer Schneide und Zylinderschaft



UM-4EFP

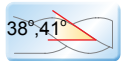
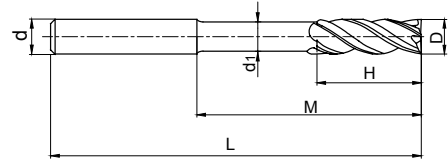

D ≤ 6 -0.020~-0.038 6 < D ≤ 10 -0.025~-0.047
10 < D ≤ 18 -0.032~-0.059 18 < D -0.04~-0.073



Type Typ	Dimension(mm) Abmessungen						Teeth Zähne Z	Stock Lager
	D	d	H	M	d ₁	L		
UM-4EFP-D6.0	6.0	6	9	30	5.8	75	4	•
UM-4EFP-D8.0	8.0	8	12	40	7.8	100	4	•
UM-4EFP-D10.0	10.0	10	15	50	9.6	100	4	•
UM-4EFP-D12.0	12.0	12	18	50	11.5	100	4	•
UM-4EFP-D16.0	16.0	16	24	50	15.5	150	4	•
UM-4EFP-D20.0	20.0	20	30	60	19.5	150	4	•

B

Solid Carbide end mills
Vollhartmetallschaftfräser

Material Overview · Material Übersicht

✓ = Very suitable · Sehr empfohlen
✓ = Suitable · Empfohlen

Workpiece material Werkstückstoff											
Carbon steel Kohlenstoff Stahl	Alloy steel Legierter Stahl	Quenched and tempered steel · Vergüteter Stahl		Hardened steel · Gehärteter Stahl		Stainless steel · Rostfreier Stahl	Cast iron, Nodular cast iron Grauguss GGG	Copper alloy Kupfer Leg	Aluminum alloy Alu Leg	Titanium alloy Titan Leg	Heat resist alloy warmfeste Leg
		~40HRC	~50HRC	~55HRC	~68HRC						
✓	✓	✓	✓	✓		✓	✓			✓	✓

Code key **B252,B254**
ISO Kennzeichen

Cutting data **B514-B517**
Schnittdaten

Graphics identification & application **B253,B255**
Graphische Werkzeug- & Anwendungsbeschr.

Order form for non-standard products **B534-B535**
Bestellformular für Sonderwerkzeuge

Milling - Fräsen

Solid Carbide end mills - Vollhartmetallschaftfräser

Recommended cutting data · Empfohlene Schnittdaten

UM-4E*UM-4EL*UM-4ELP(normal)

Workpiece material Werkstückmaterial	Carbon steel, Alloy steel Kohlenstoffstahl Leg. Stahl ~30HRC		Stainless steel Rostfreier Stahl		Pre-hardened steel, Quenched and tempered steel Vergüteter Stahl ~40HRC		Pre-hardened steel, Quenched and tempered steel Vergüteter Stahl ~50HRC		Hardened steel Gehärteter Stahl ~55HRC																
	Diameter Ø Durchmesser (mm)	Rotating Drehzahl (min ⁻¹)	Feed Vorschub (mm/min)	Rotating Drehzahl (min ⁻¹)	Feed Vorschub (mm/min)	Rotating Drehzahl (min ⁻¹)	Feed Vorschub (mm/min)	Rotating Drehzahl (min ⁻¹)	Feed Vorschub (mm/min)	Rotating Drehzahl (min ⁻¹)	Feed Vorschub (mm/min)														
4	10800	1000	5500	180	8000	770	6500	605	5570	440															
5	8200	1050	4500	180	6400	810	5000	635	4460	465															
6	7000	1080	3700	195	5300	825	4200	645	3710	465															
8	5200	1065	2800	195	4000	815	3200	665	2785	485															
10	4200	1050	2200	195	3200	810	2500	630	2230	450															
12	3500	1050	1850	195	2650	810	2100	630	1855	450															
14	3000	975	1600	180	2300	755	1800	595	1590	430															
16	2600	975	1400	170	2000	755	1600	595	1390	430															
18	2300	960	1250	150	1800	745	1400	580	1240	420															
20	2050	960	1100	150	1600	745	1250	580	1115	420															
Max. cutting depth max Schnitttiefe																									
	<table border="1"> <thead> <tr><th>Ø</th><th>Ap</th></tr> </thead> <tbody> <tr><td>Ø1≤D<Ø3</td><td>0.15D</td></tr> <tr><td>Ø3≤D<Ø6</td><td>0.3D</td></tr> <tr><td>Ø6≤D≤Ø20</td><td>0.5D</td></tr> </tbody> </table>				Ø	Ap	Ø1≤D<Ø3	0.15D	Ø3≤D<Ø6	0.3D	Ø6≤D≤Ø20	0.5D			<table border="1"> <thead> <tr><th>Ø</th><th>Ap</th></tr> </thead> <tbody> <tr><td>Ø1≤D<Ø3</td><td>0.1D</td></tr> <tr><td>Ø3≤D</td><td>0.2D</td></tr> </tbody> </table>		Ø	Ap	Ø1≤D<Ø3	0.1D	Ø3≤D	0.2D			
Ø	Ap																								
Ø1≤D<Ø3	0.15D																								
Ø3≤D<Ø6	0.3D																								
Ø6≤D≤Ø20	0.5D																								
Ø	Ap																								
Ø1≤D<Ø3	0.1D																								
Ø3≤D	0.2D																								

- The above table shows the standard value of side milling. When slot milling, of rotating speed 50%~70% and feed rate like mentioned above 40%~60%.
- Please select high precise machine and tool holder.
- Please use air blow or cutting liquid with high mist retardant property.
- Down milling is recommended in side milling.
- Vibration and unusual noise may be generated if the machine rigidity and workpiece fixture stability is low, please reduce the rotating speed and feed rate like mentioned above.
- Make overhang as short as possible if no interference.

- Die obige Tabelle zeigt Standard Werte für das Eckfräsen. Bei Nutenfräsen, Schnittgeschwindigkeit auf 50-70% und den Vorschub auf 40-60% reduzieren.
- Bitte präzise Maschinen und Werkzeughalter verwenden.
- Bitte Luftkühlung oder Schneidflüssigkeit benutzen.
- Empfohlene Fräsmethode: Gleichlaufräsen.
- Bei Vibrationen oder unüblichen Geräuschen reduzieren Sie die Schnittdaten (wie oben empfohlen) entsprechend.
- Werkzeugauskragung so kurz wie möglich wählen.

Recommended cutting data · Empfohlene Schnittdaten

UM-4E*UM-4EL*UM-4ELP(highspeed)

Workpiece material Werkstückmaterial	Carbon steel, Alloy steel Kohlenstoffstahl Leg. Stahl ~30HRC		Pre-hardened steel, Quenched and tempered steel Vergüteter Stahl ~40HRC		Pre-hardened steel, Quenched and tempered steel Vergüteter Stahl ~45HRC		Pre-hardened steel, Quenched and tempered steel Vergüteter Stahl ~50HRC		Hardened steel Gehärteter Stahl ~55HRC		
Cutting speed Schnittgeschw.	300m/min		250 m/min		200 m/min		150 m/min		100 m/min		
Diameter Ø Durchmesser (mm)	Rotating Drehzahl (min ⁻¹)	Feed Vorschub (mm/min)	Rotating Drehzahl (min ⁻¹)	Feed Vorschub (mm/min)	Rotating Drehzahl (min ⁻¹)	Feed Vorschub (mm/min)	Rotating Drehzahl (min ⁻¹)	Feed Vorschub (mm/min)	Rotating Drehzahl (min ⁻¹)	Feed Vorschub (mm/min)	
6	15915	2045	13260	1700	10600	1360	7960	1020	5300	680	
8	11935	2040	9950	1680	7960	1355	5970	1020	3980	680	
10	9550	1990	7960	1655	6370	1330	4775	995	3180	660	
12	7960	1990	6630	1655	5300	1330	3980	995	2650	660	
14	6820	1850	5685	1545	4550	1235	3410	1080	2275	615	
16	5970	1850	4975	1545	3980	1235	2985	1080	1990	615	
18	5305	1850	4420	1545	3540	1235	2650	1080	1770	615	
20	4775	1850	3980	1545	3180	1235	2390	1080	1590	615	
Max. cutting depth max Schnitttiefe											

1. Please select high precise machine and tool holder.
2. Please use air blow or MQL (minimum oil mist cooling).
3. Down milling is recommended in side milling.
4. Vibration and unusual noise may be generated if the machine rigidity and workpiece fixture stability is low, please reduce the rotating speed and feed rate like mentioned above.
5. Make overhang as short as possible if no interference.

1. Bitte präzise Maschinen und Werkzeughalter verwenden.
2. Als Kühlmittel bitte Luft oder MQL (Minimalmengen) verwenden.
3. Empfohlene Fräsmethode: Gleichlaufräsen.
4. Bei Vibrationen oder unüblichen Geräuschen reduzieren Sie die Schnittdaten (wie oben empfohlen) entsprechend.
5. Werkzeugauskragung so kurz wie möglich wählen.

Milling · Fräsen

Solid Carbide end mills · Vollhartmetallschaftfräser

Recommended cutting data · Empfohlene Schnittdaten

UM-4EFP (normal)

Workpiece material Werkstückmaterial	Cast iron, Nodular cast iron Grauguss GGG		Stainless steel Rostfreier Stahl		Pre-hardened steel, Quenched and tempered steel Vergüteter Stahl ~40HRC		Pre-hardened steel, Quenched and tempered steel Vergüteter Stahl ~50HRC		Hardened steel Gehärteter Stahl ~55HRC	
	Rotating Drehzahl (min ⁻¹)	Feed Vorschub (mm/min)	Rotating Drehzahl (min ⁻¹)	Feed Vorschub (mm/min)	Rotating Drehzahl (min ⁻¹)	Feed Vorschub (mm/min)	Rotating Drehzahl (min ⁻¹)	Feed Vorschub (mm/min)	Rotating Drehzahl (min ⁻¹)	Feed Vorschub (mm/min)
6	7000	1400	3700	250	5300	1080	4200	845	3710	610
8	5200	1385	2800	250	4000	1060	3200	865	2785	630
10	4200	1365	2200	250	3200	1050	2500	815	2230	585
12	3500	1365	1850	250	2650	1050	2100	815	1855	585
16	2600	1270	1400	220	2000	975	1600	770	1390	560
20	2050	1255	1100	195	1600	965	1250	755	1115	545

Max. cutting depth max Schnitttiefe			

1. The above table shows the standard value of side milling. When slot milling, of rotating speed 50%~70% and feed rate like mentioned above 40%~60%.
2. Please select high precise machine and tool holder.
3. Please use air blow or cutting liquid with high mist retardant property.
4. Down milling is recommended in side milling.
5. Vibration and unusual noise may be generated if the machine rigidity and workpiece fixture stability is low, please reduce the rotating speed and feed rate like mentioned above.
6. Make overhang as short as possible if no interference.

1. Die obige Tabelle zeigt Standard Werte für das Eckfräsen. Bei Nutenfräsen, Schnittgeschwindigkeit auf 50-70% und den Vorschub auf 40-60% reduzieren.
2. Bitte präzise Maschinen und Werkzeughalter verwenden.
3. Bitte Luftkühlung oder Schneidflüssigkeit benutzen.
4. Empfohlene Fräsmethode: Gleichlaufräsen.
5. Bei Vibrationen oder unüblichen Geräuschen reduzieren Sie die Schnittdaten (wie oben empfohlen) entsprechend.
6. Werkzeugauskragung so kurz wie möglich wählen.

Recommended cutting data · Empfohlene Schnittdaten

UM-4EFP (highspeed)

Workpiece material Werkstückmaterial	Carbon steel, Alloy steel Kohlenstoffstahl Leg. Stahl ~30HRC		Pre-hardened steel, Quenched and tempered steel Vergüteter Stahl ~40HRC		Pre-hardened steel, Quenched and tempered steel Vergüteter Stahl ~45HRC		Pre-hardened steel, Quenched and tempered steel Vergüteter Stahl ~50HRC		Hardened steel Gehärteter Stahl ~55HRC	
	Cutting speed Schnittgeschw.		250 m/min		200 m/min		150 m/min		100 m/min	
Diameter Ø Durchmesser (mm)	Rotating Drehzahl (min ⁻¹)	Feed Vorschub (mm/min)	Rotating Drehzahl (min ⁻¹)	Feed Vorschub (mm/min)	Rotating Drehzahl (min ⁻¹)	Feed Vorschub (mm/min)	Rotating Drehzahl (min ⁻¹)	Feed Vorschub (mm/min)	Rotating Drehzahl (min ⁻¹)	Feed Vorschub (mm/min)
6	15915	2655	13260	2210	10600	1770	7960	1325	5300	885
8	11935	2650	9950	2180	7960	1760	5970	1295	3980	885
10	9550	2590	7960	2150	6370	1730	4775	1295	3180	855
12	7960	2590	6630	2150	5300	1730	3980	1400	2650	855
16	5970	2410	4975	2015	3980	1605	2985	1400	1990	800
20	4775	2410	3980	2375	3180	1605	2390	1325	1590	800
Max. cutting depth max Schnitttiefe										

1. Please select high precise machine and tool holder.
2. Please use air blow or MQL (minimum oil mist cooling).
3. Down milling is recommended in side milling.
4. Vibration and unusual noise may be generated if the machine rigidity and workpiece fixture stability is low, please reduce the rotating speed and feed rate like mentioned above.
5. Make overhang as short as possible if no interference.

1. Bitte präzise Maschinen und Werkzeughalter verwenden.
2. Als Kühlmittel bitte Luft oder MQL (Minimalmengen) verwenden.
3. Empfohlene Fräsmethode: Gleichlaufräsen.
4. Bei Vibrationen oder unüblichen Geräuschen reduzieren Sie die Schnittdaten (wie oben empfohlen) entsprechend.
5. Werkzeugauskragung so kurz wie möglich wählen.

Milling · Fräsen

Solid Carbide end mills · Vollhartmetallschaftfräser

4-flute radius end mills with straight shank 4-Schneiden Radiuseckfräser mit Zylinderschaft



UM-4R

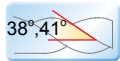
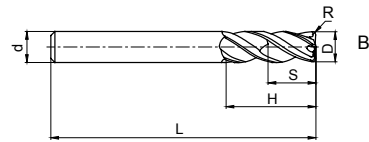
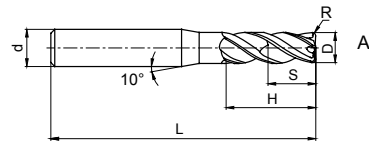

$\frac{D}{\downarrow}$	D ≤ 6	-0.020 ~ -0.038	6 < D ≤ 10	-0.025 ~ -0.047
	10 < D ≤ 18	-0.032 ~ -0.059	18 < D	-0.04 ~ -0.073



Type Typ	Dimension (mm) Abmessungen						Teeth Zähne Z	Geometry Ausführung	Stock Lager
	D	R	d	H	S	L			
UM-4R-D4.0R0.3	4.0	0.3	6	10	6.0	50	4	A	●
UM-4R-D4.0R0.5	4.0	0.5	6	10	6.0	50	4	A	●
UM-4R-D5.0R0.5	5.0	0.5	6	13	7.5	50	4	A	●
UM-4R-D5.0R1.0	5.0	1.0	6	13	7.5	50	4	A	●
UM-4R-D6.0R0.5	6.0	0.5	6	16	9.0	50	4	B	●
UM-4R-D6.0R1.0	6.0	1.0	6	16	9.0	50	4	B	●
UM-4R-D8.0R0.5	8.0	0.5	8	20	12	60	4	B	●
UM-4R-D8.0R1.0	8.0	1.0	8	20	12	60	4	B	●
UM-4R-D10.0R0.5	10.0	0.5	10	25	15	75	4	B	●
UM-4R-D10.0R1.0	10.0	1.0	10	25	15	75	4	B	●
UM-4R-D10.0R2.0	10.0	2.0	10	25	15	75	4	B	●
UM-4R-D10.0R3.0	10.0	3.0	10	25	15	75	4	B	●
UM-4R-D12.0R0.5	12.0	0.5	12	30	18	75	4	B	●
UM-4R-D12.0R1.0	12.0	1.0	12	30	18	75	4	B	●
UM-4R-D12.0R2.0	12.0	2.0	12	30	18	75	4	B	●
UM-4R-D12.0R3.0	12.0	3.0	12	30	18	75	4	B	●
UM-4R-D16.0R1.0	16.0	1.0	16	45	24	100	4	B	●
UM-4R-D16.0R2.0	16.0	2.0	16	45	24	100	4	B	●
UM-4R-D16.0R3.0	16.0	3.0	16	45	24	100	4	B	●
UM-4R-D20.0R1.0	20.0	1.0	20	45	30	100	4	B	●
UM-4R-D20.0R2.0	20.0	2.0	20	45	30	100	4	B	●
UM-4R-D20.0R3.0	20.0	3.0	20	45	30	100	4	B	●

WW

Material Overview · Material Übersicht

✓ = Very suitable · Sehr empfohlen
 ✓ = Suitable · Empfohlen

Workpiece material Werkstückstoff											
Carbon steel Kohlenstoff Stahl	Alloy steel Legierter Stahl	Quenched and tempered steel · Vergüteter Stahl		Hardened steel · Gehärteter Stahl		Stainless steel · Rostfreier Stahl	Cast iron, Nodular cast iron Grauguss GGG	Copper alloy Kupfer Leg	Aluminum alloy Alu Leg	Titanium alloy Titan Leg	Heat resist alloy warmfeste Leg
		~40HRC	~50HRC	~55HRC	~68HRC						
✓	✓	✓	✓	✓		✓	✓			✓	✓

● Ex Stock / ab Lager ○ On demand / auf Anfrage

4-flute radius end mills with straight shank and long cutting edge
4-Schneiden Radiuseckfräser mit langer Schneide und Zylinderschaft



UM-4RL

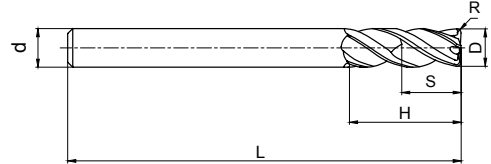

D	D ≤ 6	-0.020 ~ -0.038	6 < D ≤ 10	-0.025 ~ -0.047
	10 < D ≤ 18	-0.032 ~ -0.059	18 < D	-0.04 ~ -0.073



Type Typ	Dimension (mm) Abmessungen						Teeth Zähne Z	Stock Lager
	D	R	d	H	S	L		
UM-4RL-D6.0R0.5	6.0	0.5	6	16	9	75	4	•
UM-4RL-D6.0R1.0	6.0	1.0	6	16	9	75	4	•
UM-4RL-D8.0R0.5	8.0	0.5	8	20	12	100	4	•
UM-4RL-D8.0R1.0	8.0	1.0	8	20	12	100	4	•
UM-4RL-D10.0R0.5	10.0	0.5	10	25	15	100	4	•
UM-4RL-D10.0R1.0	10.0	1.0	10	25	15	100	4	•
UM-4RL-D10.0R2.0	10.0	2.0	10	25	15	100	4	•
UM-4RL-D12.0R0.5	12.0	0.5	12	30	18	100	4	•
UM-4RL-D12.0R1.0	12.0	1.0	12	30	18	100	4	•
UM-4RL-D12.0R2.0	12.0	2.0	12	30	18	100	4	•
UM-4RL-D16.0R1.0	16.0	1.0	16	45	24	150	4	•
UM-4RL-D16.0R2.0	16.0	2.0	16	45	24	150	4	•

B

Solid Carbide end mills
Vollhartmetallschaftfräser

Material Overview · Material Übersicht

✓ = Very suitable · Sehr empfohlen
✓ = Suitable · Empfohlen

Workpiece material Werkstückstoff											
Carbon steel Kohlenstoff Stahl	Alloy steel Legierter Stahl	Quenched and tempered steel · Vergüteter Stahl		Hardened steel · Gehärteter Stahl		Stainless steel · Rostfreier Stahl	Cast iron, Nodular cast iron Grauguss GGG	Copper alloy Kupfer Leg	Aluminum alloy Alu Leg	Titanium alloy Titan Leg	Heat resist alloy wärmefeste Leg
		~40HRC	~50HRC	~55HRC	~68HRC						
✓	✓	✓	✓	✓		✓	✓			✓	✓

Code key **B252, B254**
ISO Kennzeichen

Cutting data **B521-B523**
Schnittdaten

Graphics identification & application **B253, B255**
Graphische Werkzeug- & Anwendungsbeschr.

Order form for non-standard products **B534-B535**
Bestellformular für Sonderwerkzeuge

Milling · Fräsen

Solid Carbide end mills · Vollhartmetallschaftfräser

4-flute radius end mills with straight shank and short cutting edge and long neck
4-Schneiden Radiuseckfräser mit kurzer Schneide und Zylinderschaft



UM-4RFP

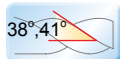
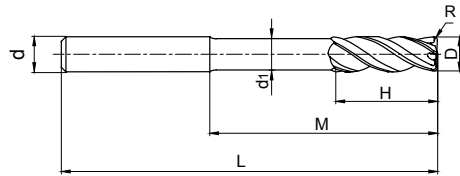

D	D ≤ 6	-0.020 ~ -0.038	6 < D ≤ 10	-0.025 ~ -0.047
	10 < D ≤ 18	-0.032 ~ -0.059	18 < D	-0.04 ~ -0.073



Type Typ	Dimension (mm) Abmessungen							Teeth Zähne Z	Stock Lager
	D	R	d	d ₁	H	M	L		
UM-4RFP-D6.0R0.5	6.0	0.5	6	5.8	6	18	75	4	●
UM-4RFP-D6.0R1.0	6.0	1.0	6	5.8	6	18	75	4	●
UM-4RFP-D8.0R0.5	8.0	0.5	8	7.7	8	24	100	4	●
UM-4RFP-D8.0R1.0	8.0	1.0	8	7.7	8	24	100	4	●
UM-4RFP-D10.0R0.5	10.0	0.5	10	9.6	10	30	100	4	●
UM-4RFP-D10.0R1.0	10.0	1.0	10	9.6	10	30	100	4	●
UM-4RFP-D10.0R2.0	10.0	2.0	10	9.6	10	30	100	4	●
UM-4RFP-D12.0R0.5	12.0	0.5	12	11.5	12	36	100	4	●
UM-4RFP-D12.0R1.0	12.0	1.0	12	11.5	12	36	100	4	●
UM-4RFP-D12.0R2.0	12.0	2.0	12	11.5	12	36	100	4	●
UM-4RFP-D16.0R1.0	16.0	1.0	16	15.5	16	40	150	4	●
UM-4RFP-D16.0R2.0	16.0	2.0	16	15.5	16	40	150	4	●

Solid Carbide end mills
Vollhartmetallschaftfräser

B

Material Overview · Material Übersicht

✓ = Very suitable · Sehr empfohlen
✓ = Suitable · Empfohlen

Workpiece material Werkstückstoff											
Carbon steel Kohlenstoff Stahl	Alloy steel Legierter Stahl	Quenched and tempered steel · Vergüteter Stahl		Hardened steel · Gehärteter Stahl		Stainless steel · Rostfreier Stahl	Cast iron, Nodular cast iron Grauguss GGG	Copper alloy Kupfer Leg	Aluminum alloy Alu Leg	Titanium alloy Titan Leg	Heat resist alloy warmfeste Leg
		~40HRC	~50HRC	~55HRC	~68HRC						
✓	✓	✓	✓	✓		✓	✓			✓	✓

● Ex Stock / ab Lager ○ On demand / auf Anfrage

Recommended cutting data · Empfohlene Schnittdaten

UM-4R*UM-4RL (normal)

Workpiece material Werkstückmaterial	Carbon steel, Alloy steel Kohlenstoffstahl Leg. Stahl ~30HRC		Pre-hardened steel, Quenched and tempered steel Vergüteter Stahl ~40HRC		Pre-hardened steel, Quenched and tempered steel Vergüteter Stahl ~45HRC		Pre-hardened steel, Quenched and tempered steel Vergüteter Stahl ~50HRC		Hardened steel Gehärteter Stahl ~55HRC	
	Diameter Ø Durchmesser (mm)	Rotating Drehzahl (min ⁻¹)	Feed Vorschub (mm/min)	Rotating Drehzahl (min ⁻¹)	Feed Vorschub (mm/min)	Rotating Drehzahl (min ⁻¹)	Feed Vorschub (mm/min)	Rotating Drehzahl (min ⁻¹)	Feed Vorschub (mm/min)	Rotating Drehzahl (min ⁻¹)
4.0×R0.3 4.0×R0.5	7950	3960	6350	2880	5550	2520	4000	1650	2400	755
5.0×R0.5 5.0×R1.0	6350	4200	5100	3060	4450	2670	3200	1710	1900	690
6.0×R0.5 6.0×R1.0	5300	4200	4250	3060	3700	2670	2650	1710	1600	690
8.0×R0.5 8.0×R1.0	4550	4200	3200	3060	2800	2670	2000	1710	1200	690
10.0×R0.5 10.0×R1.0 10.0×R2.0 10.0×R3.0	3200	4200	2550	3060	2250	2670	1600	1710	955	690
12.0×R0.5 12.0×R1.0 12.0×R2.0 12.0×R3.0	2650	4200	2100	3060	1850	2670	1350	1710	795	690
16.0×R1.0 16.0×R2.0 16.0×R3.0	2200	3485	1745	2540	1535	2215	1140	1420	660	570
20.0×R1.0 20.0×R2.0 20.0×R3.0	1825	2895	1450	2110	1275	1840	960	1180	550	475
Max. cutting depth max Schnittiefe	max a _p =0.5mm						max a _p =0.4mm		max a _p =0.2mm	

- The above table shows the standard value of side milling. When slot milling, of rotating speed 50%~70% and feed rate like mentioned above 40%~60%.
- Please select high precise machine and tool holder.
- Please use air blow or cutting liquid with high mist retardant property.
- Down milling is recommended in side milling.
- Vibration and unusual noise may be generated if the machine rigidity and workpiece fixture stability is low, please reduce the rotating speed and feed rate like mentioned above.
- Make overhang as short as possible if no interference.

- Die obige Tabelle zeigt Standard Werte für das Eckfräsen. Bei Nutenfräsen, Schnittgeschwindigkeit auf 50-70% und den Vorschub auf 40-60% reduzieren.
- Bitte präzise Maschinen und Werkzeughalter verwenden.
- Bitte Luftkühlung oder Schneidflüssigkeit benutzen.
- Empfohlene Fräsmethode: Gleichlaufräsen.
- Bei Vibrationen oder ungewöhnlichen Geräuschen reduzieren Sie die Schnittdaten (wie oben empfohlen) entsprechend.
- Werkzeugauskragung so kurz wie möglich wählen.

L/D	Vc(m/min)	a _e (mm)	fn(mm/min)
L/D≤4	100%	100%	100%
L/D=5	60% ~ 80%	60% ~ 80%	60% ~ 80%
L/D=6	40% ~ 60%	40% ~ 60%	40% ~ 60%

Milling - Fräsen

Solid Carbide end mills - Vollhartmetallschaftfräser

Recommended cutting data - Empfohlene Schnittdaten

UM-4R*UM-4RL (highspeed)

Workpiece material Werkstückmaterial	Carbon steel, Alloy steel Kohlenstoffstahl Leg. Stahl ~30HRC		Pre-hardened steel, Quenched and tempered steel Vergüteter Stahl ~40HRC		Pre-hardened steel, Quenched and tempered steel Vergüteter Stahl ~45HRC		Pre-hardened steel, Quenched and tempered steel Vergüteter Stahl ~50HRC		Hardened steel Gehärteter Stahl ~55HRC	
	Diameter Ø Durchmesser (mm)	Rotating Drehzahl (min ⁻¹)	Feed Vorschub (mm/min)	Rotating Drehzahl (min ⁻¹)	Feed Vorschub (mm/min)	Rotating Drehzahl (min ⁻¹)	Feed Vorschub (mm/min)	Rotating Drehzahl (min ⁻¹)	Feed Vorschub (mm/min)	Rotating Drehzahl (min ⁻¹)
4.0×R0.3 4.0×R0.5	16000	7800	16000	7200	12000	5400	12000	4920	7950	2130
5.0×R0.5 5.0×R1.0	12500	8400	12500	7500	9550	5730	9550	5160	6350	2280
6.0×R0.5 6.0×R1.0	10600	8400	10600	7620	7950	5730	7950	5160	5300	2280
8.0×R0.5 8.0×R1.0	7950	8400	7950	7620	5950	5730	5950	5160	4000	2280
10.0×R0.5 10.0×R1.0 10.0×R2.0 10.0×R3.0	6350	8400	6350	7620	4750	5730	4750	5160	3200	2280
12.0×R0.5 12.0×R1.0 12.0×R2.0 12.0×R3.0	5300	8400	5300	7620	4000	5730	4000	5160	2650	2280
16.0×R1.0 16.0×R2.0 16.0×R3.0	3980	6970	3980	6320	2985	4755	2985	4280	1990	1890
20.0×R1.0 20.0×R2.0 20.0×R3.0	3185	5785	3185	5245	2385	3945	2385	3550	1590	1570
	max a _p =0.4mm						max a _p =0.2mm		max a _p =0.1mm	
Max. cutting depth max Schnitttiefe										

1. Please select high precise machine and tool holder.
2. Please use air blow or MQL (minimum oil mist cooling).
3. Down milling is recommended in side milling.
4. Vibration and unusual noise may be generated if the machine rigidity and workpiece fixture stability is low, please reduce the rotating speed and feed rate like mentioned above.
5. Make overhang as short as possible if no interference.
6. For overhang of L/D ≤ 4 please use cutting condition from table above. For bigger overhang see table below

1. Bitte präzise Maschinen und Werkzeughalter verwenden.
2. Als Kühlmittel bitte Luft oder MQL (Minimalmengen) verwenden.
3. Empfohlene Fräsmethode: Gleichlauffräsen.
4. Bei Vibrationen oder unüblichen Geräuschen reduzieren Sie die Schnittdaten (wie oben empfohlen) entsprechend.
5. Werkzeugauskrägung so kurz wie möglich wählen.
6. Für Auskräglängen L/D ≤ 4 bitte die Parameter aus der Tabelle oben verwenden. Für L/D > 4 siehe Tabelle unten.

L/D	V _c (m/min)	a _e (mm)	f _n (mm/min)
L/D ≤ 4	100%	100%	100%
L/D = 5	60% ~ 80%	60% ~ 80%	60% ~ 80%
L/D = 6	40% ~ 60%	40% ~ 60%	40% ~ 60%

Recommended cutting data · Empfohlene Schnittdaten

UM-4RFP

Workpiece material Werkstückmaterial	Carbon steel, Alloy steel Kohlenstoffstahl Leg. Stahl ~30HRC		Stainless steel Rostfreier Stahl		Pre-hardened steel, Quenched and tempered steel Vergüteter Stahl ~40HRC		Pre-hardened steel, Quenched and tempered steel Vergüteter Stahl ~50HRC		Hardened steel Gehärteter Stahl ~55HRC															
	Diameter Ø Durchmesser (mm)	Rotating Drehzahl (min ⁻¹)	Feed Vorschub (mm/min)	Rotating Drehzahl (min ⁻¹)	Feed Vorschub (mm/min)	Rotating Drehzahl (min ⁻¹)	Feed Vorschub (mm/min)	Rotating Drehzahl (min ⁻¹)	Feed Vorschub (mm/min)	Rotating Drehzahl (min ⁻¹)	Feed Vorschub (mm/min)													
	4	10800	1210	5500	210	8000	925	6500	720	5570	530													
	5	8200	1265	4500	210	6400	965	5000	765	4460	560													
	6	7000	1295	3700	235	5300	995	4200	780	3710	560													
	8	5200	1285	2800	235	4000	975	3200	790	2785	580													
	10	4200	1265	2200	235	3200	965	2500	750	2230	540													
	12	3500	1265	1850	235	2650	965	2100	750	1855	540													
	16	2600	1180	1400	210	2000	925	1600	705	1390	520													
Max. cutting depth max Schnitttiefe																								
	<table border="1"> <thead> <tr> <th>Ø</th> <th>Ap</th> </tr> </thead> <tbody> <tr> <td>Ø1 ≤ D < Ø3</td> <td>0.15D</td> </tr> <tr> <td>Ø3 ≤ D < Ø6</td> <td>0.3D</td> </tr> <tr> <td>Ø6 ≤ D ≤ Ø20</td> <td>0.5D</td> </tr> </tbody> </table>					Ø	Ap	Ø1 ≤ D < Ø3	0.15D	Ø3 ≤ D < Ø6	0.3D	Ø6 ≤ D ≤ Ø20	0.5D			<table border="1"> <thead> <tr> <th>Ø</th> <th>Ap</th> </tr> </thead> <tbody> <tr> <td>Ø1 ≤ D < Ø3</td> <td>0.1D</td> </tr> <tr> <td>Ø3 ≤ D</td> <td>0.2D</td> </tr> </tbody> </table>		Ø	Ap	Ø1 ≤ D < Ø3	0.1D	Ø3 ≤ D	0.2D	
Ø	Ap																							
Ø1 ≤ D < Ø3	0.15D																							
Ø3 ≤ D < Ø6	0.3D																							
Ø6 ≤ D ≤ Ø20	0.5D																							
Ø	Ap																							
Ø1 ≤ D < Ø3	0.1D																							
Ø3 ≤ D	0.2D																							

B

Solid Carbide end mills
Vollhartmetallschaftfräser

1. The above table shows the standard value of side milling. When slot milling, of rotating speed 50%~70% and feed rate like mentioned above 40%~60%.
2. Please select high precise machine and tool holder.
3. Please use air blow or cutting liquid with high mist retardant property.
4. Down milling is recommended in side milling.
5. Vibration and unusual noise may be generated if the machine rigidity and workpiece fixture stability is low, please reduce the rotating speed and feed rate like mentioned above.
6. Make overhang as short as possible if no interference.

1. Die obige Tabelle zeigt Standard Werte für das Eckfräsen. Bei Nutenfräsen, Schnittgeschwindigkeit auf 50-70% und den Vorschub auf 40-60% reduzieren.
2. Bitte präzise Maschinen und Werkzeughalter verwenden.
3. Bitte Luftkühlung oder Schneidflüssigkeit benutzen.
4. Empfohlene Fräsmethode: Gleichlaufräsen.
5. Bei Vibrationen oder unüblichen Geräuschen reduzieren Sie die Schnittdaten (wie oben empfohlen) entsprechend.
6. Werkzeugauskragung so kurz wie möglich wählen.

Milling · Fräsen

Solid Carbide end mills · Vollhartmetallschaftfräser

VSM-4E for difficult to machine material with sharp cutting edge

VSM-4E für schwerzerspanbares Material, mit scharfer Schneide

4-flute end mills with straight shank and long cutting edge

4-Schneiden Eckfräser mit langer Schneide und Zylinderschaft

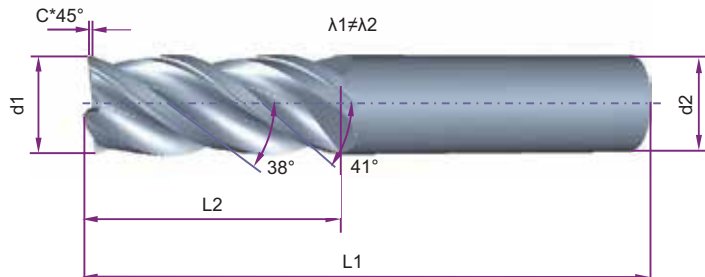
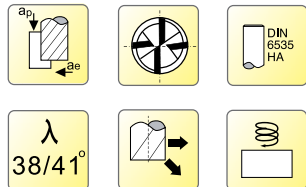
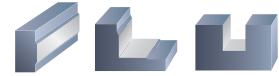

Type Typ	*	Dimension(mm) Abmessungen					Teeth Zähne	Application Anwendung	Grade Sorte	P M S
		d1	d2	L2	L1	C*45°				
VSM-4E-D4.0	*	4	6	11	50	0.01-0.06	4			●
VSM-4E-D5.0	*	5	6	13	50	0.01-0.06	4			●
VSM-4E-D6.0	*	6	6	16	50	0.06-0.10	4			●
VSM-4E-D8.0	*	8	8	20	60	0.06-0.10	4			●
VSM-4E-D10.0	*	10	10	25	75	0.06-0.10	4			●
VSM-4E-D12.0	*	12	12	30	75	0.10-0.15	4			●
VSM-4E-D16.0	*	16	16	45	100	0.10-0.15	4			●
VSM-4E-D20.0	*	20	20	45	100	0.15-0.20	4			●

Material Overview · Material Übersicht

✓ = Very suitable · Sehr empfohlen
 ✓ = Suitable · Empfohlen

KMG405

Workpiece material Werkstückstoff											
Carbon steel Kohlenstoff Stahl	Alloy steel Legierter Stahl	Quenched and tempered steel · Vergüteter Stahl		Hardened steel · Gehärteter Stahl		Stainless steel · Rostfreier Stahl	Cast iron, Nodular cast iron Grauguss GGG	Copper alloy Kupfer Leg	Aluminum alloy Alu Leg	Titanium alloy Titan Leg	Heat resist alloy warmfeste Leg
		~40HRC	~50HRC	~60HRC	~68HRC						
✓	✓	✓				✓				✓	✓

● Ex Stock / ab Lager ○ On demand / auf Anfrage * With internal cooling · Mit Innenkühlung

Recommended cutting data · Empfohlene Schnittdaten

VSM-4E

Workpiece material Werkstückmaterial	Carbon steel / Alloy steel Kohlenstoff Stahl / legierter Stahl		Stainless steel · Rostfreier Stahl		Heat resist. alloy / Warmfeste Leg. Titanium alloy / Titan-Legier.	
	Diameter Ø Durchmesser (mm)	Rotating Drehzahl (min ⁻¹)	Feed Vorschub (mm/min)	Rotating Drehzahl (min ⁻¹)	Feed Vorschub (mm/min)	Rotating Drehzahl (min ⁻¹)
4	6400	1200	3700	590	2350	180
5	5800	1300	3000	600	1900	190
6	5300	1500	2700	640	1900	220
8	3900	1100	2000	480	1400	170
10	3100	930	1600	400	1100	150
12	2600	780	1300	360	950	140
16	1900	680	1000	280	720	120
20	1500	540	800	260	570	95

Max. cutting depth max Schnitttiefe	Carbon steel / Alloy steel Kohlenstoff Stahl / legierter Stahl		Stainless steel · Rostfreier Stahl		Heat resist. alloy / Warmfeste Leg. Titanium alloy / Titan-Legier.	
	Ae	Ap	Ae	Ap	Ae	Ap
	Ae=0.2D	Ap=1.5D	Ae=0.05D	Ap=1D	Ae=1D	Ap=0.05D
	Ae=1D	Ap=0.3D	Ae=0.05D	Ap=1D	Ae=1D	Ap=0.05D

- The above table shows the standard value of side milling. When slot milling, rotating speed is around 80%~100% of standard value, Feed is around 60%~80% of standard value.
- Recommend using non water-soluble cutting liquid when machining stainless steel and Heat resist. alloy Warmfeste Leg..
- Please select high rigid and precise machine and tool holder.
- Adjust rotating speed and feed according to cutting depth and machine rigidity.
- Down milling is recommended in side milling.
- Make overhang as short as possible if no interference.

- Die obige Tabelle zeigt Standart Schnittwerte für das Eckfräsen, beim Nutenfräsen die Schnittgeschwindigkeit auf ca. 80% und den Vorschub auf 60%-80% reduzieren.
- Nicht wasserlösliche Kühlschmiermittel verwenden.
- Bitte Maschine und Werkzeugaufnahme mit hoher Präzision und Stabilität wählen.
- Schnittgeschwindigkeit und Vorschub der Schnitttiefe und Maschinenstabilität anpassen.
- Fräsmethode zum Eckfräsen: Gleichlaufräsen.
- Die Werkzeugauskragung so kurz wie möglich wählen.

Milling - Fräsen

VSM-4R for difficult to machine material with radius

VSM-4R für schwerzerspanbares Material, mit Radius



4-flute end mills with radius
4-Schneiden VHM Schafffräser mit Radius

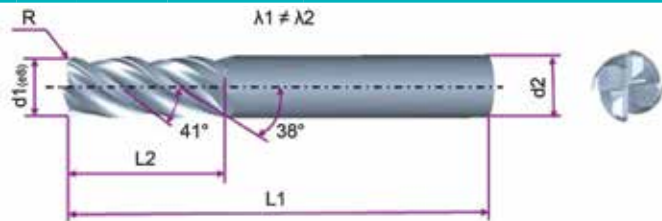
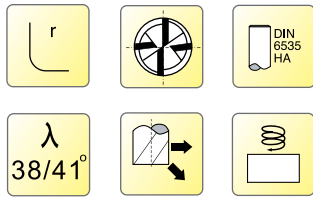

Type Typ	Dimension(mm) Abmessungen					Teeth Zähne	Applicaion Anwendung	Grade Sorte	P M S		
	d1(e8)	R±0.01	d2(h6)	L1	L2				KMG 405		
VSM-4R-D4.0R0.2	4	0.2	6	50	11	4			●		
VSM-4R-D4.0R0.5	4	0.5	6	50	11	4			●		
VSM-4R-D5.0R0.2	5	0.2	6	50	13	4			●		
VSM-4R-D5.0R0.5	5	0.5	6	50	13	4			●		
VSM-4R-D6.0R0.2	6	0.2	6	50	16	4			●		
VSM-4R-D6.0R0.5	6	0.5	6	50	16	4			●		
VSM-4R-D6.0R1.0	6	1.0	6	50	16	4			●		
VSM-4R-D6.0R1.5	6	1.5	6	50	16	4			●		
VSM-4R-D8.0R0.5	8	0.5	8	63	20	4			●		
VSM-4R-D8.0R0.8	8	0.8	8	63	20	4			●		
VSM-4R-D8.0R1.0	8	1.0	8	63	20	4			●		
VSM-4R-D8.0R1.5	8	1.5	8	63	20	4			●		
VSM-4R-D8.0R2.0	8	2.0	8	63	20	4			●		
VSM-4R-D10.0R0.5	10	0.5	10	75	25	4			●		
VSM-4R-D10.0R0.8	10	0.8	10	75	25	4			●		
VSM-4R-D10.0R1.0	10	1.0	10	75	25	4			●		
VSM-4R-D10.0R1.5	10	1.5	10	75	25	4			●		
VSM-4R-D10.0R2.0	10	2.0	10	75	25	4			●		
VSM-4R-D12.0R0.5	12	0.5	12	75	30	4			●		
VSM-4R-D12.0R0.8	12	0.8	12	75	30	4			●		
VSM-4R-D12.0R1.0	12	1.0	12	75	30	4			●		
VSM-4R-D12.0R1.5	12	1.5	12	75	30	4			●		
VSM-4R-D12.0R2.0	12	2.0	12	75	30	4			●		
VSM-4R-D12.0R2.5	12	2.5	12	75	30	4			●		
VSM-4R-D12.0R3.0	12	3.0	12	75	30	4			●		
VSM-4R-D12.0R4.0	12	4.0	12	75	30	4			●		
VSM-4R-D16.0R0.5	16	0.5	16	100	45	4			●		
VSM-4R-D16.0R0.8	16	0.8	16	100	45	4			●		
VSM-4R-D16.0R1.0	16	1.0	16	100	45	4			●		
VSM-4R-D16.0R1.5	16	1.5	16	100	45	4			●		
VSM-4R-D16.0R2.0	16	2.0	16	100	45	4			●		
VSM-4R-D16.0R2.5	16	2.5	16	100	45	4			●		
VSM-4R-D16.0R3.0	16	3.0	16	100	45	4			●		
VSM-4R-D16.0R4.0	16	4.0	16	100	45	4			●		
VSM-4R-D20.0R0.5	20	0.5	20	100	45	4			●		
VSM-4R-D20.0R1.0	20	1.0	20	100	45	4			●		
VSM-4R-D20.0R1.5	20	1.5	20	100	45	4			●		
VSM-4R-D20.0R2.0	20	2.0	20	100	45	4			●		
VSM-4R-D20.0R2.5	20	2.5	20	100	45	4			●		
VSM-4R-D20.0R3.0	20	3.0	20	100	45	4			●		
VSM-4R-D20.0R4.0	20	4.0	20	100	45	4			●		

Material Overview · Material Übersicht

✓ = Very suitable · Sehr empfohlen
✓ = Suitable · Empfohlen

Workpiece material Werkstückstoff											
Carbon steel Kohlenstoff Stahl	Alloy steel Legierter Stahl	Quenched and tempered steel · Vergüteter Stahl		Hardened steel · Gehärteter Stahl		Stainless steel · Rostfreier Stahl	Cast iron, Nodular cast iron Grauguss GGG	Copper alloy Kupfer Leg	Aluminum alloy Alu Leg	Titanium alloy Titan Leg	Heat resist alloy warmfeste Leg
		~40HRC	~50HRC	~60HRC	~68HRC						
✓	✓	✓				✓				✓	✓

● Ex Stock / ab Lager ○ On demand / auf Anfrage

B

Solid Carbide end mills
Vollhartmetallschafffräser

KMG405
B 526

Recommended cutting data · Empfohlene Schnittdaten

VSM-4R

Workpiece material Werkstückmaterial	Carbon steel / Alloy steel Kohlenstoff Stahl / legierter Stahl		Stainless steel · Rostfreier Stahl		Heat resist. alloy / Warmfeste Leg. Titanium alloy / Titan-Legier.		
	Diameter Ø Durchmesser (mm)	Rotating Drehzahl (min ⁻¹)	Feed Vorschub (mm/min)	Rotating Drehzahl (min ⁻¹)	Feed Vorschub (mm/min)	Rotating Drehzahl (min ⁻¹)	Feed Vorschub (mm/min)
	6	5300	900	2700	240	2470	145
	8	3900	840	2000	255	1820	155
	10	3100	770	1600	255	1430	155
	12	2600	720	1300	205	1235	135
	16	1900	625	1000	180	935	110

Max. cutting depth max Schnitttiefe	Carbon steel / Alloy steel Kohlenstoff Stahl / legierter Stahl		Stainless steel · Rostfreier Stahl		Heat resist. alloy / Warmfeste Leg. Titanium alloy / Titan-Legier.	

- The above table shows the standard value of side milling. When slot milling, rotating speed is around 80%~100% of standard value, feed is around 60%~80% of standard value.
- Recommend using water-insoluble cutting liquid when machining stainless steel and Heat resist. alloy Warmfeste Leg.
- Please select high rigid and precise machine and tool holder.
- Adjust rotating speed and feed according to cutting depth and machine rigidity.
- Down milling is recommended in side milling.
- Make overhang as short as possible if no interference.
- For overhang of $L/D \leq 4$ please use cutting condition from table above. If $L/D > 4$, please reduce the cutting speed and feed rate about 70%.

- Die obige Tabelle zeigt Standard Schnittwerte für das Eckfräsen, beim Nutenfräsen die Schnittgeschwindigkeit auf ca. 80% und den Vorschub auf 60%-80% reduzieren.
- Nicht wasserlösliche Kühlschmiermittel verwenden.
- Bitte Maschine und Werkzeugaufnahme mit hoher Präzision und Stabilität wählen.
- Schnittgeschwindigkeit und Vorschub der Schnitttiefe und Maschinenstabilität anpassen.
- Fräsmethode zum Eckfräsen: Gleichlaufräsen.
- Die Werkzeugauskragung so kurz wie möglich wählen.
- Für Werkzeugauskragung $L/D \leq 4$ bitte die Parameter aus der Tabelle oben verwenden. Bei $L/D > 4$, bitte die Schnittgeschwindigkeit und den Vorschub auf 70% reduzieren.

Deburring Cutter *Entgratfräser*



Deburring Cutter 90° Entgratfräser 90°

5501/5601

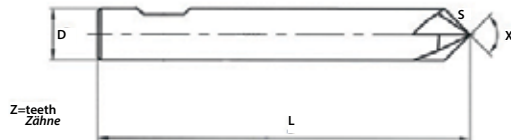

Coating
Coated

Article no. Artikel Nr.	Dimension (mm) Abmessung					Shank Schaft	P M K Grade / Sorte KMG 303
	D	L	S	Z	X		
5501R903FM-0300	3	48	2.1	3	90	HA	●
5501R904FM-0400	4	48	2.8	4	90	HA	●
5601R904FM-0600	6	55	4.2	4	90	HB	●
5601R904FM-0800	8	58	5.6	4	90	HB	●
5601R904FM-1000	10	65	7.0	4	90	HB	●
5601R904FM-1200	12	75	8.5	4	90	HB	●
5601R904FM-1600	16	85	11.3	4	90	HB	●

Deburring Cutter 60° Entgratfräser 60°

5501/5601

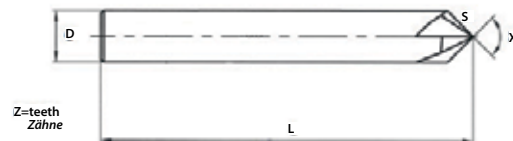

Coating
Coated

Article no. Artikel Nr.	Dimension (mm) Abmessung					Shank Schaft	P M K Grade / Sorte KMG 303
	D	L	S	Z	X		
5501R603FM-0300	3	48	3	3	60	HA	●
5501R604FM-0400	4	48	4	4	60	HA	●
5601R604FM-0600	6	55	6	4	60	HB	●
5601R604FM-0800	8	58	8	4	60	HB	●
5601R604FM-1000	10	65	10	4	60	HB	●
5601R604FM-1200	12	75	12	4	60	HB	●
5601R604FM-1600	16	85	16	4	60	HB	●

Code key B252,B254
ISO Kennzeichen

Cutting data B530
Schnittdaten

Graphics identification & application B253,B255
Graphische Werkzeug- & Anwendungsbeschr.

Order form for non-standard products B534-B535
Bestellformular für Sonderwerkzeuge

Milling - Fräsen

Solid Carbide end mills - Vollhartmetallschaftfräser

Corner Radius Cutter Viertelkreisfräser

5601



Coating
Coated

Article no. Artikel Nr.	Dimension (mm) Abmessung					Shank Schaft	P M K Grade / Sorte KMG 303
	d1	D	L	Z	R		
5601R904FM-R02-0600	5.6	6	60	4	0.2	HB	●
5601R904FM-R03-0600	5.4	6	60	4	0.3	HB	●
5601R904FM-R04-0600	5.2	6	60	4	0.4	HB	●
5601R904FM-R05-0800	7.0	8	70	4	0.5	HB	●
5601R904FM-R06-0800	6.8	8	70	4	0.6	HB	●
5601R904FM-R075-0800	6.5	8	70	4	0.75	HB	●
5601R904FM-R08-0800	6.4	8	70	4	0.8	HB	●
5601R904FM-R10-0800	6.0	8	70	4	1.0	HB	●
5601R904FM-R15-1000	7.0	10	75	4	1.5	HB	●
5601R904FM-R20-1000	6.0	10	75	4	2.0	HB	●
5601R904FM-R25-1200	7.0	12	75	4	2.5	HB	●
5601R904FM-R30-1200	6.0	12	75	4	3.0	HB	●
5601R904FM-R40-1600	8.0	16	80	4	4.0	HB	●
5601R904FM-R50-2000	10.0	20	80	4	5.0	HB	●

Recommended Cutting data Empfohlene Schnittdaten

Material Werkstoffe		D (mm)	Vc (m/min)	Feed rate Vorschub fz (mm/Z)	Material Werkstoffe		D (mm)	Vc (m/min)	Feed rate Vorschub fz (mm/Z)
P	Steel Stahl	3	70-120	0,01	K	Cast iron Guss	3	90	0,01
		4	70-120	0,02			4	90	0,02
		6	70-120	0,03			6	90	0,03
		8	70-120	0,04			8	90	0,04
		10	70-120	0,05			10	90	0,05
		12	70-120	0,06			12	90	0,06
M	Stainless Steel Rostfreier Stahl	3	60-90	0,01	N	Nonferrite Materials Ne-Metalle	3	200-280	0,01
		4	60-90	0,02			4	200-280	0,02
		6	60-90	0,03			6	200-280	0,03
		8	60-90	0,04			8	200-280	0,04
		10	60-90	0,05			10	200-280	0,05
		12	60-90	0,06			12	200-280	0,06
		16	60-90	0,08			16	200-280	0,08

● Ex Stock / ab Lager ○ On demand / auf Anfrage

Parts terminology of end mill · Terminologie von VHM Fräsern

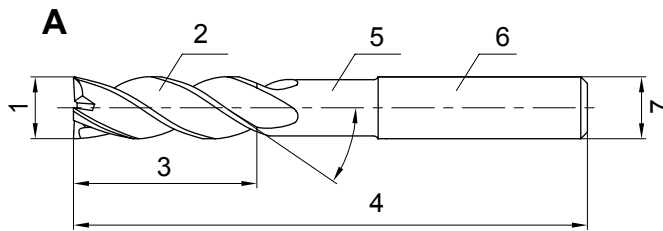

- A**
- 1) Cutting edge diameter / Schneiddurchmesser
 - 2) Chip pocket / Spanraum
 - 3) Length of cutting edge / Schneidenlänge
 - 4) Overall length / Gesamtlänge
 - 5) Neck / Hals
 - 6) Shank / Schaft
 - 7) Shank diameter / Schaftdurchmesser

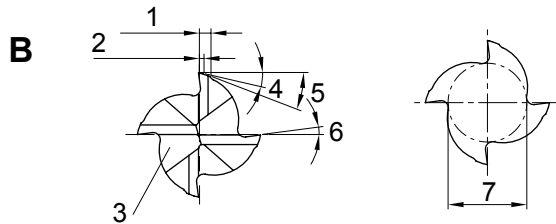

- B**
- 1) Land width / Fasenbreite, Hauptschneide
 - 2) Relief land width / Fasenbreite, Durchmesser
 - 3) Gash / Freischliff, stirnseitig
 - 4) Radial primary relief angle / Primärer radialer Freiwinkel
 - 5) Radial secondary relief angle / Sekundärer radialer Freiwinkel
 - 6) Radial rake angle / Radialer Spanwinkel
 - 7) Wep thickness / Kerndurchmesser

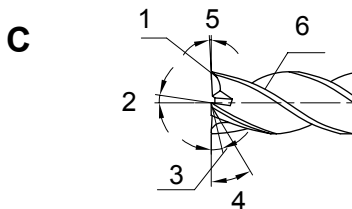

- C**
- 1) Corner / Schneidecke
 - 2) Axial rake angle / Axialer Spanwinkel
 - 3) Axial primary relief angle / Axialer primärer Freiwinkel
 - 4) Axial secondary relief angle / Axialer sekundärer Freiwinkel
 - 5) Lead angle / Neigungswinkel
 - 6) Peripheral cutting edge / Peripherie Schneidkante

Teeth, chip pocket and tool rigidity · Zähne, Spanraum und Stabilität

Teeth · Zähne		2 Flutes · Schneiden	3 Flutes · Schneiden	4 Flutes · Schneiden
Profile of cross section Schnittdarstellung				
Proportion of cross section Anteil Schnittdarstellung		54%	56%	60%
Features Merkmal	Advantages Vorteile	<ul style="list-style-type: none"> • Large chip pocket • Good chip removal • Große Spankammer • Gute Spanabfuhr 	<ul style="list-style-type: none"> • Good chip removal • Perfect surface finish • Gute Spanabfuhr • Gute Oberflächengüte 	<ul style="list-style-type: none"> • Good rigidity • Perfect surface finish • Gute Steifigkeit • Gute Oberflächengüte
Application Anwendung		<ol style="list-style-type: none"> 1. Slot machining 2. Side face machining 3. Hole machining <ol style="list-style-type: none"> 1. Nutenfräsen 2. Eckfräsen 3. Bohrungsbearbeitung 	<ol style="list-style-type: none"> 1. Slot machining 2. Side face machining 3. For finishing <ol style="list-style-type: none"> 1. Nutenfräsen 2. Eckfräsen 3. Schlichtbearbeitung 	<ol style="list-style-type: none"> 1. Shallow slot machining 2. Side face machining 3. For finishing <ol style="list-style-type: none"> 1. Nutenfräsen (flach) 2. Eckfräsen 3. Schlichtbearbeitung

Milling · Fräsen

Solid Carbide end mills · Vollhartmetallschaftfräser

Length of cutting edge (overhang) and cutting diameter Länge der Schneidenauskragung und Schneidendurchmesser

The shorter the overhang, the stronger the rigidity. Thus isn't easy to generate. Bend and vibration in the cutting process may accrue. Length (overhang) increases by 1 time, the Deflection degree (f) will be 8 times of the former one.

Je kürzer die Werkzeugauskragung, um so stabiler ist die Bearbeitungssituation.

Während der Bearbeitung können Werkzeugdurchbiegungen und Vibrationen entstehen.

Bei Vergrößerung der Auskragung um 100% wird der Deflektionsgrad (Ablenkung) um das 8-fache erhöht.

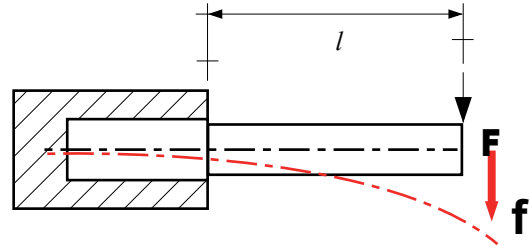

$$f = \frac{F \cdot l^3}{3 \cdot E \cdot I} = \frac{F \cdot l^3 \cdot 64}{3 \cdot E \cdot d^4 \cdot \pi}$$

Reduce the overhang by 20%, the Deflection degree (f) will decrease by 50%
Increase the diameter by 20%, the Deflection degree (f) will decrease by 50%

Bei Reduzierung der Auskragung um 20 % reduziert sich der Deflektionsgrad (Ablenkung) um 50 %.
Bei Vergrößerung des Werkzeugdurchmessers um 20 % reduziert sich der Deflektionsgrad (Ablenkung) um 50 %.

Typical geometries of end mills · Typische Geometrien von Schaftfräsern

Type · Typ	Geometry · Ausführung
End mill Schaftfräser	
R-End mill Radiuseckfräser	
Ball nose end mill Kugelkopffräser	
Roughing end mill Schruppfräser	
Tapered end mill Konusfräser	

B

Solid Carbide end mills
Vollhartmetallschaftfräser

Technical information · Technische Informationen

Feed rate selecting table in profile machining for ball nose and R end mills Vorschubwerte für das Formfräsen mit Kugelkopffräsern und Radiuseckfräsern

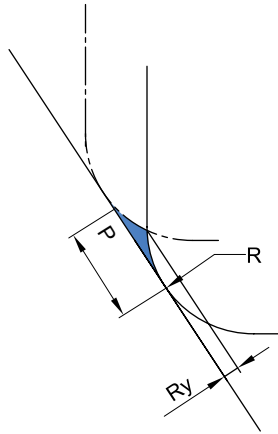

$$Ry = R \times \{1 - \cos[\arcsin(fr/2R)]\}$$

Ry: Theoretical value of surface roughness
P: Feed rate
R: Ball nose radius or corner radius

Ry: Theoretische Werte der Oberflächenqualität.
P: Vorschub
R: Kugelkopf- oder Radiusfräser

R Ry	Feed rate P · Vorschub									
	0.1	0.2	0.3	0.4	0.5	0.6	0.7	0.8	0.9	1.0
0.5	0.003	0.010	0.023	0.042	0.067	0.100				
1.0	0.001	0.005	0.011	0.020	0.032	0.046	0.063	0.083	0.107	
1.5	0.001	0.003	0.008	0.013	0.021	0.030	0.041	0.054	0.069	0.086
2.0	0.001	0.003	0.006	0.010	0.015	0.023	0.031	0.040	0.051	0.064
2.5	0.001	0.002	0.005	0.008	0.013	0.018	0.025	0.032	0.041	0.051
3.0		0.001	0.004	0.007	0.010	0.015	0.020	0.027	0.034	0.042
4.0		0.001	0.003	0.005	0.008	0.011	0.015	0.020	0.025	0.031
5.0		0.001	0.002	0.004	0.006	0.009	0.012	0.016	0.020	0.025
6.0			0.002	0.003	0.005	0.008	0.010	0.013	0.017	0.021
8.0			0.001	0.003	0.004	0.006	0.008	0.010	0.013	0.016
10.0			0.001	0.002	0.003	0.005	0.006	0.008	0.010	0.013
12.5			0.001	0.002	0.003	0.004	0.005	0.006	0.008	0.010

R Ry	Feed rate P · Vorschub									
	1.1	1.2	1.3	1.4	1.5	1.6	1.7	1.8	1.9	2.0
0.5										
1.0										
1.5	0.104									
2.0	0.077	0.092	0.109							
2.5	0.061	0.073	0.086	0.100						
3.0	0.051	0.061	0.071	0.083	0.095	0.109				
4.0	0.038	0.045	0.053	0.062	0.071	0.081	0.091	0.103		
5.0	0.030	0.036	0.042	0.049	0.057	0.064	0.073	0.082	0.091	0.101
6.0	0.025	0.030	0.035	0.041	0.047	0.054	0.061	0.068	0.076	0.084
8.0	0.019	0.023	0.026	0.031	0.035	0.040	0.045	0.051	0.057	0.063
10.0	0.015	0.018	0.021	0.025	0.028	0.032	0.036	0.041	0.045	0.050
12.5	0.012	0.014	0.017	0.020	0.023	0.026	0.029	0.032	0.036	0.040

Milling · Fräsen

Solid Carbide end mills · Vollhartmetallschaftfräser

Non-standard · Sonderwerkzeuge

Name:

Fax:

Tel:

E-MAIL:



Heltorfer Straße 12
40472 Düsseldorf Germany

Fax: +49-(0)211-989240-111

E-Mail: info@zccct-europe.com

Workpiece material · Werkstückstoff

Carbon steel Kohlenstoff Stahl	Alloy steel Legierter Stahl	Hardened steel · gehärteter Stahl				Stainless steel Rostfreier Stahl	Cast iron, Nodular cast iron Grauguss GGG	Copper alloy Kupfer Leg.	Aluminum Alu.	Aluminum alloy Alu. Leg. rausnehmen	Titanium alloy Titan Leg.	Heat resist. alloy Warmfest Leg.
		~40HRC	~50HRC	~60HRC	~68HRC							

Series Series						
GM	PM	UM	HM	NM	AL	VSM

Diameter Durchmesser Ø	Ø 0.3 - 20.0mm
Teeth Schneidenanzahl	

Type · Typ

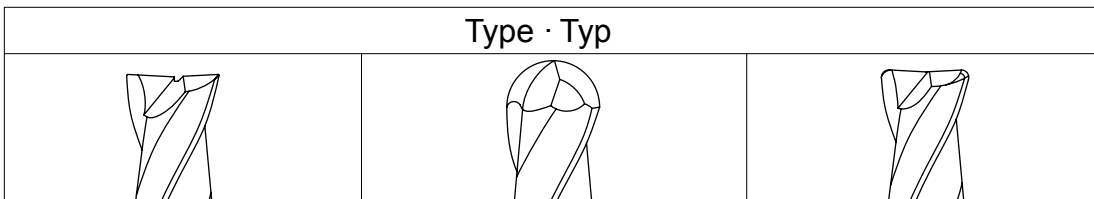

Flat end milling
Eckfräsen

Ball end milling
Kugelfräsen

Round arc milling
Radiuseckfräsen

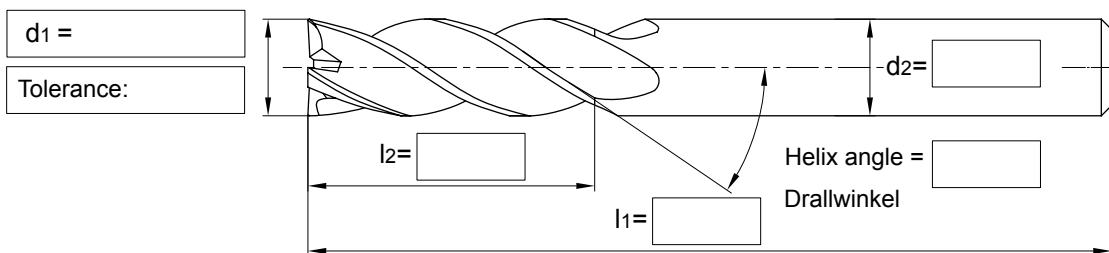

Remarks:
Bemerkungen:

Order quantity: pieces
Auftragsmenge: Stücke

Expected delivery date:
Gewünschtes Lieferdatum:

Date · Datum:

Confirmation · Unterschrift:

B

Solid Carbide end mills
Vollhartmetallschaftfräser

Non-standard · Sonderwerkzeuge

Name:	 Heltorfer Straße 12 40472 Düsseldorf Germany Fax: +49-(0)211-989240-111 E-Mail: info@zccct-europe.com
Fax:	
Tel:	
E-MAIL:	

Workpiece material · Werkstückstoff





Carbon steel Kohlenstoff Stahl	Alloy steel Legierter Stahl	Hardened steel · gehärteter Stahl				Stainless steel Rostfreier Stahl	Cast iron, Nodular cast iron Grauguss GGG	Copper alloy Kupfer Leg.	Aluminum Alu.	Aluminum alloy Alu. Leg. rausnehmen	Titanium alloy Titan Leg.	Heat resist. alloy Warmfest Leg.
		~40HRC	~50HRC	~60HRC	~68HRC							

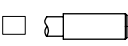
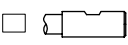
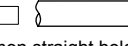
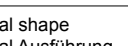

Diameter(d1) Ø	Ø0.5 - 25.0mm
Teeth No. Schneidenanzahl	
End edge over center: Schneide über Mitte	<input type="checkbox"/> Yes <input type="checkbox"/> No

Coating Beschichtung
Yes <input type="checkbox"/>
No <input type="checkbox"/>

Holder Type Aufnahmetyp	
DIN6535	<input type="checkbox"/>  Form HA
	<input type="checkbox"/>  Form HB
<input type="checkbox"/>  Common straight holder Normal Rundschaft	
<input type="checkbox"/>  Special shape Spezial Ausführung	

Cutter Information · Fräseninformationen

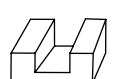
Type · Typ			
 Flat end milling Eckfräsen <input type="checkbox"/>	 Chamfer flat end milling Eckfräsen mit Fase <input type="checkbox"/>	 Ball end milling Kugelfräsen <input type="checkbox"/>	 Round arc milling Radiuseckfräsen <input type="checkbox"/>

Machining method · Bearbeitungen		
 Groove milling Nutenfräsen <input type="checkbox"/>	 Side milling Eckfräsen <input type="checkbox"/>	 Copy milling Formfräsen <input type="checkbox"/>

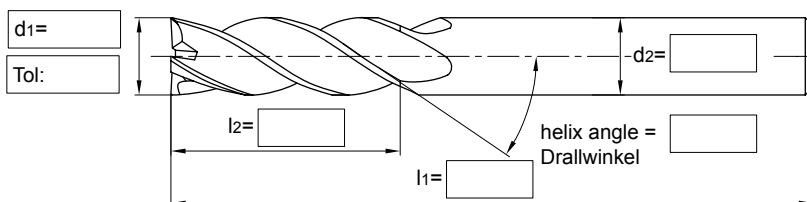

Remarks:
Bemerkungen:

Order quantity: pieces
 Auftragsmenge: Stücke

Expected delivery date:
 Gewünschtes Lieferdatum:

Date · Datum:

Confirmation · Unterschrift:

B

Solid Carbide end mills
 Vollhartmetallschaftfräser



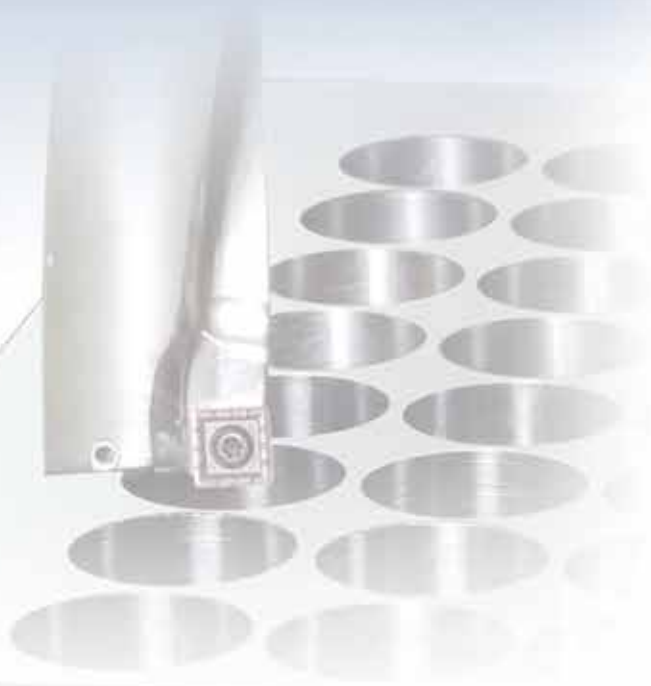

Drilling tools Bohrwerkzeuge

Drills

Solid carbide drills
Indexable drills

C5-C140

C6-C121
C123-C140

Bohrer

VHM Bohrer
Wendeschneidplattenbohrer

Reamers

Solid carbide reamers

C141-C152

C142-C152

Reibahlen

VHM Reibahlen

Threading tools

Solid carbide thread forming
Solid carbide threading tools
Solid carbide threading mills

C153-C174

C155-C159
C160-C167
C169-C170

Gewindewerkzeuge

VHM Gewindeformer
VHM Gewindebohrer
VHM Gewindefräser



C4

Drilling · Bohren

Drilling tools · Bohrwerkzeuge

Drilling tools overview	C6	Übersicht Bohrwerkzeuge
Solid carbide drills	C7-C121	VHM Bohrer
Grade introduction for solid carbide drills	C7	Sortenbeschreibung für VHM Bohrer
Solid carbide drills code key	C8	ISO Kennzeichnung für VHM Bohrer
Recommended cutting datas for solid carbide drills	C96-C109	Empfohlene Schnittdaten für VHM Bohrer
Technical information for solid carbide drills	C110-C116	Technische Informationen für VHM Bohrer
Order form for non-standard products	C117-C121	Bestellformular für Sonderwerkzeuge
Indexable drills	C123-C140	Wendeschneidplattenbohrer
Indexable drills code key	C123	ISO Kennzeich. von Wendeplattenbohrern
Indexable drills	C124-C131	Wendeplattenbohrer
Drilling inserts code key	C132-C133	ISO Kennzeichnung für Bohrwendeplatten
Technical information for drills	C138-C139	Technische Informationen für WSP-Bohrer
Recommended cutting data for drills	C140	Empfohlene Schnittdaten für WSP-Bohrer
Reaming	C141-C152	Reiben
Solid carbide reamers overview	C142	VHM Reibahlen Übersicht
Graphics identification	C142	Graphische Werkzeugbeschreibung
Code key	C143	ISO Kennzeichnung
Solid carbide reamer program	C144-C147	Programm VHM Reibahlen
Recommended cutting datas	C148	Empfohlene Schnittdaten
Technical information	C149-C151	Technische Informationen
Order form for non-standard products	C152	Bestellformular für Sonderwerkzeuge
Threading tools overview	C154	Gewindewerkzeuge Übersicht
Graphics identification	C154	Graphische Werkzeugbeschreibung
Threading tools code key	C155	ISO Kennzeichnung
Detail information	C154-C173	Detaillierte Informationen
Solid carbide thread forming	C155-C159	VHM Gewindeformer
Solid carbide threading tools	C160-C167	VHM Gewindebohrer
Solid carbide threading end mills	C169-C170	VHM Gewindefräser
Recommended cutting data	C171	Empfohlene Schnittdaten
Technical information	C172	Technische Information
Order form for non-standard products	C173	Bestellformular für Sonderwerkzeuge

Drilling · Bohren

Solid Carbide drills, Indexable drill · Vollhartmetallbohrer, WSP-Bohrer

Drilling tools overview · Bohrer Übersicht

Machining Bearbeitung	Typ of drill Bohrertyp	Type Typ	L/D	Shape of drills Bohrerausführung	Cooling mode Kühlmittel	Ø	material · Material								Page Seite		
							P	M	K	N	S	H	Specification Spezifikation	Cutting data Schnittdaten			
							Carbon steel Kohlenstoff - Stahl	Alloy steel Legierter Stahl	Stainless steel Rostfreier Stahl	Cast iron Grauguss	Non-ferrous metal NE-Metalle	Heat resistant alloy Warmfeste Leg.			Hardened steel Gehärteter Stahl		
General machining Allgemeine Bearbeitung	Twist drill Spiralbohrer	1534SU03	3xD		External Extern	Ø0.9-Ø20	✓	✓	✓	✓					C10- C50	C96- C98	
		1534SU03C	3xD		Internal Intern	Ø3-Ø20	✓	✓	✓	✓							
		1634SU03C	3xD		Internal Intern	Ø3-Ø20	✓	✓	✓	✓							
		1734SU03C	3xD		Internal Intern	Ø3-Ø20	✓	✓	✓	✓							
		1536SU05	5xD		External Extern	Ø2-Ø20	✓	✓	✓	✓							
		1536SU05C	5xD		Internal Intern	Ø3-Ø20	✓	✓	✓	✓							
		1636SU05C	5xD		Internal Intern	Ø3-Ø20	✓	✓	✓	✓							
		1736SU05C	5xD		Internal Intern	Ø3-Ø20	✓	✓	✓	✓							
		1538SU08C	8xD		Internal Intern	Ø3-Ø18	✓	✓	✓	✓							
	Deep drill Tieflochbohrer	1588SL10C	10xD		Internal Intern	Ø3-Ø14	✓	✓	✓	✓		✓		C52- C62	C100		
		1588SL12C	12xD		Internal Intern	Ø3-Ø21	✓	✓	✓	✓		✓					
		1588SL15C	15xD		Internal Intern	Ø3-Ø14	✓	✓	✓	✓		✓					
		1588SL20C	20xD		Internal Intern	Ø3-Ø14	✓	✓	✓	✓		✓					
		1588SL30C	30xD		Internal Intern	Ø3-Ø10	✓	✓	✓	✓		✓					
	Pilot drills Pilotbohrer	1534SP03C	3xD		Internal Intern	Ø3.03- Ø20.03	✓	✓	✓	✓		✓	C63- C66	C101			
	Step drill Stufenbohrer	1557SU03	3xD		External Extern	M4-M16	✓	✓	✓	✓		✓	C51	C99			
	Carbon steel alloy steel Kohlenstoff - Stahl Legierter Stahl	Twist drill Spiralbohrer	1534ST03C	3xD		Internal Intern	Ø3-Ø20	✓	✓	✓		✓	C69- C81	C103			
			1536ST05C	5xD		Internal Intern	Ø3-Ø20	✓	✓	✓		✓					
			1636ST05C	5xD		Internal Intern	Ø3-Ø20	✓	✓	✓		✓					
	high hardness steel Gehärteter Stahl	Twist drill Spiralbohrer	1534SH03	3xD		External Extern	Ø3-Ø16						✓	C82- C83	C104		
For aluminum, cast iron Für Aluminium, Gusseisen	Twist drill Spiralbohrer	1105SC03	3xD		External Extern	Ø2-Ø16			✓	✓			C84- C87	C105			
		1101SC05	5xD		External Extern	Ø2-Ø16			✓	✓							
	Three-lips drill Dreilippenbohrer	1165PA03	3xD		External Extern	Ø3-Ø20				✓	✓		C88- C90	C106			
	Straight flute drill Gerade genuteter Bohrer	1576PC05	5xD		External Extern	Ø4-Ø20			✓	✓				C91- C93	C107- C108		
		1576PC05C	5xD		Internal Intern	Ø4-Ø20			✓	✓							
		1579PC15C	15xD		Internal Intern	Ø5-Ø14			✓	✓							
	Centering drill Zentrierbohrer	1143SC90			External Extern	Ø5-Ø20			✓	✓				C94	C109		
		1143SC120			External Extern	Ø5-Ø20			✓	✓							
Indexable drills series WSP-Bohrer	Indexable drills WSP-Bohrer	ZTD02/03	2xD-		Internal Intern	Ø13-Ø50	✓	✓	✓	✓			C124- C129	C136 C140			
		ZTD04/05	5xD		Internal Intern	Ø13-Ø50	✓	✓	✓	✓							
		ZD03	3xD		Internal Intern	Ø16-Ø58	✓	✓	✓	✓					C130- C131		

✓ = Very suitable · Sehr empfohlen
 ✓ = Suitable · Empfohlen

Grade introduction for solid carbide drills Hartmetallsorten für VHM-Bohrer

Coated Grade **KDG303** Beschichtete Sorte

It is a combination of ultra-fine carbide substrate and Nano nc-ALTiN coating. It is a universal grade for machining of carbon steel, alloy steel (HRC<=48), cast iron and stainless steel. Suitable for the machining of Ni based high-temperature alloys at normal cutting speed.

Eine Kombination von Ultrafeinkorn-Hartmetall und Nano nc-TiAlN PVD-Beschichtung. Universelle Anwendung zur Bearbeitung von unlegiertem Stahl, legiertem Stahl (HRC<=48), Guss, rostfreiem Stahl und Ni-basierten, wärmefesten Superlegierungen bei normaler Schnittgeschwindigkeit.

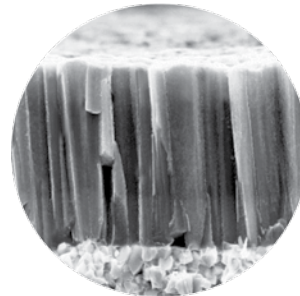

Common TiAlN coating
normale TiAlN Beschichtung

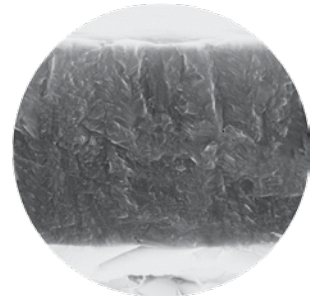

nc-ALTiN coating
nc-ALTiN Beschichtung

Application of nc-ALTiN coating in drilling Anwendungsbeispiel von nc-ALTiN	
Tool Type · Typ	1534SU03C-1200
Size · Durchmesser	Ø12mm
Workpiece material Werkstückstoff	42CrMo (32HRC)
Cutting speed Schnittgeschw.	100m/min
Rotating speed Umdreh. pro min	2652r/min
Feed rate per revolution Vorschub pro Umdrehung	0.25mm/r
Feed speed · Vorschub	663mm/min
Drilling depth · Bohrtiefe	36mm
Cooling system Kühlungssystem	Water-soluble liquid (Internal) Emulsion (Interne Zuführung)
Machine · Maschine	Mikron UCP 1000

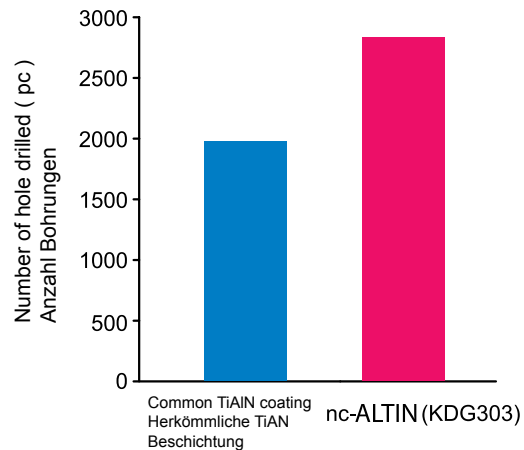

Uncoated grades Unbeschichtete Sorten

YK20F

It is an ultra-fine carbide grade with good wear resistance suitable for drilling and reaming of cast iron and nonferrous metals.

Ultrafeinkorn-Hartmetall mit guter Verschleißfestigkeit.

Geeignet zum Bohren und Reiben von Guss und NE-Metallen.

YK30F

It is an ultra-fine carbide grade with good wear-resistance. A universal grade for drilling.

Ultrafeinkorn-Hartmetall mit guter Verschleißfestigkeit.

Universelle Sorte zum Bohren.

Drilling · Bohren

Solid carbide drills · Vollhartmetallbohrer

Solid carbide drills Code Key · ISO Kennzeichnung für VHM-Bohrer

Description Bezeichnung	
Code	Description · Beschreibung
1	DIN338
2	DIN1897
3	QJ/ZZQ(TO)01.001.002
4	DIN6537K
5	DIN6537K
6	DIN6537K
7	ZZC-C in QJ/ZZQ(TO)01.001.002
8	ZZC-D in QJ/ZZQ(TO)01.001.002
9	ZZC-E in QJ/ZZQ(TO)01.001.002

Application Anwendung	
Code	Description · Beschreibung
SU	Twist drill for general universal machining Spiralbohrer für die allg. Bearbeitung
SUK	Twist drill for grey cast iron Spiralbohrer für Graugussmaterial
SL	Twist drill for deep drilling Spiralbohrer zum Tieflochbohren
SLK	Deep drills for grey cast iron Tieflochbohrer für Graugussmaterialien
SP	Pilot drills Pilotbohrer
ST	Twist drill for soft steel, stainless steel Spiralbohrer für weiche Stähle und rostfr. Stahl
SH	Twist drill for high hardness steel Spiralbohrer für gehärteten Stahl
SC	Twist drill for aluminum, cast iron Spiralbohrer für Alu und Grauguss
PA	Three-lips drill for aluminum, cast iron 3-Lippenbohrer für Alu-Leg., Grauguss
PC	Straight flute drill for aluminum, cast iron gerade genuteter Bohrer für Alu, Grauguss

Type of tools Werkzeugtyp	
Code	Description · Beschreibung
1	Drills · Bohrer

Mode of cooling Art der Kühlung	
Code	Description · Beschreibung
C	Internal Coolant Innere Kühlmittelzufuhr

1 5 3 6 SU 05 C -0850

Type of shank · Schaftausführung	
Code	Description · Beschreibung
1	Straight shank Zylinderschaftausführung
2	Square head Straight shank DIN 10 4-Kant-Schaft DIN 10
3	Double flattened Straight shank DIN1809 2-Flächen-Zylinderschaft DIN1809
5	Straight shank DIN6535HA Zylinderschaft DIN6535HA
6	Weldon shank DIN6535HB Weldon Schaft DIN6535HB
7	Whistle notch shank DIN6535HE Whistle-Notch-Schaft DIN6535HE
9	Tapered shank MK-Schaft

Type of drill · Bohrertyp	
Code	Description · Beschreibung
0	Twist drill Spiralbohrer
3	Multiple functions twist drill Universalspiralbohrer
4	Centering drill Zentrierbohrer
5	Step drill Stufenbohrer
6	Three-lips drill 3-Schneidenbohrer
7	Straight flute drill Bohrer mit geraden Nuten

Specification · Bezeichnung	
Code	Description · Beschreibung
0850	Nominal cutting diameter of stepless drill Bohrerdurchmesser: 8,5mm
M6	Step drill for standard pitch Gewindebohrer Standardsteigungen
M8x1	Step drill for fine pitch Gewindebohrer mit Feingewinde

Identification of drilling depth and point angle · max. Bohrtiefe

If the tool is not a centering drill, it indicate the drilling depth Ist das Werkzeug kein Zentrierbohrer wird die Bohrtiefe angegeben.		If the tool is a centering drill, it indicate the point angle Ist das Werkzeug kein Zentrierbohrer wird der Spitzenwinkel angegeben.	
Code	Description · Beschreibung	Code	Description · Beschreibung
03	(2~3) d	90	Centering drill with 90° point angle NC-Anbohrer mit 90° Winkel
05	(4~5) d		
08	(7~8) d		
15	(15) d	120	Centering drill with 120° point angle NC-Anbohrer mit 120° Winkel

C

Solid carbide drills
Vollhartmetallbohrer

SU Series twist drill Spiralbohrer Serie

SU Universal series · Universalausführung

The optimized chip-breaker, shape of the cutting edge and a proper change of the rake angle combined with a TiAlN nano coating for a wider application field. It is for the drilling of work piece materials of P(steel), M(stainless steel) and K(cast iron) with high performance.

Eine optimierte Schneidengeometrie in Verbindung mit einer Nano TiAlN-Beschichtung ermöglicht eine Hochleistungsbearbeitung beim Bohren in allgemeinen Stahlwerkstoffen, rostfreien Werkstoffen und Guss.



Specially designed drill point makes cutting smooth.

Spezielle Geometrie für weichen Schnitt

SUK **NEW** DIN 1412 D

Twist drills for grey cast iron Spiralbohrer für die Bearbeitung von Graugussmaterialien

For grey cast iron
Für Graugussmaterialien

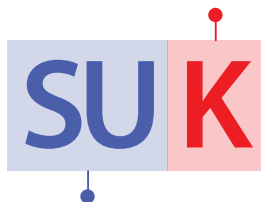

Twist drill for deep drilling
Spiralbohrer zum Tieflochbohren

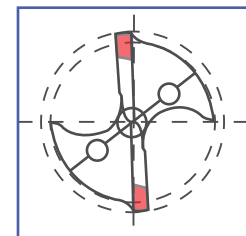
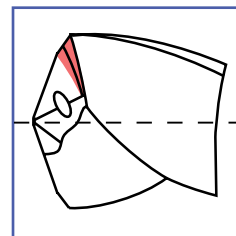

Form D - Double Angle for Cast Iron
Form D - Anschliff für Grauguss

- **Applications / Anwendung:**
For drilling grey cast iron, malleable cast iron and forgings.
Für Bohrungen in Grauguss, Temperguss und Schmiedestücke.
- **Advantages / Vorteile:**
Wear on cutting corners is reduced by extended major cutting edges, resistant to impact, good heat conductivity, all giving improved tool life.
Schonung der Schneidenecken durch verlängerte Hauptschneiden, unempfindlich gegen Stoß, gute Wärmeableitung – dadurch verbesserte Standzeit.

All articles SUK on demand, please add **K when ordering.**
Alle Artikel SUK auf Anfrage, bitte bei der Bestellung **K ergänzen.**

1534SUK**K**03-0100

Drilling · Bohren

Solid carbide drills · Vollhartmetallbohrer

SU&SUK

Please add K when ordering / Bitte bei der Bestellung K ergänzen

General machining · Allgemeine Bearbeitung

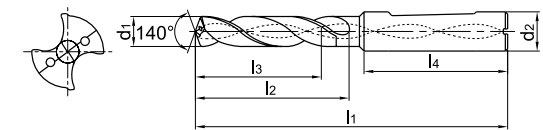
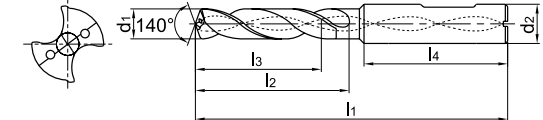
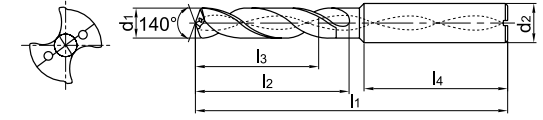
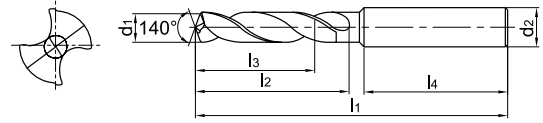
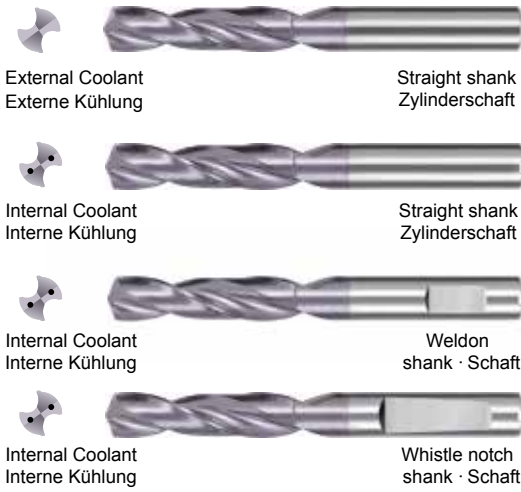

- For high efficient drilling of P (steel), M (stainless steel) and K (cast iron) with high performance.
- Waveform cutting edges achieve outstanding sharpness and strength, promoting chip removal.
- Hocheffizientes Bohren von allgemeinen Stahlwerkstoffen, rostfreien Werkstoffen und Guss.
- Wellenförmige Schneidkante mit hoher Schneidschärfe, Stabilität und guter Spanabfuhr.

Drill diameter Bohrer Ø d1(m7)	Drilling depth Bohrtiefe (L/d1)	Cooling mode Kühlmittel.	Shank Schaft	Type Typ	Basic dimension(mm) · Basis Abmessungen					Grade Sorte
					Shank diameter Ø Schaftdurchmesser	Overall length Gesamtlänge	Flute length Nutenlänge	effective drill. length Effektive Nutzlänge	Shank length Schaftlänge	
					d2(h6)	l1	l2	l3	l4	
0.90	3	External Extern	Straight shank Zylinder- schaft	1534SU03-0090	4	47	3.4	4.2	37.9	●
1.00	3			1534SU03-0100	4	47	3.8	4.7	37.6	●
1.05	3			1534SU03-0105	4	47	3.9	4.9	37.5	○
1.10	3			1534SU03-0110	4	47	4.1	5.2	37.2	●
1.15	3			1534SU03-0115	4	47	4.3	5.4	37.1	○
1.20	3			1534SU03-0120	4	47	4.5	5.6	37	●
1.25	3			1534SU03-0125	4	47	4.7	5.9	36.8	○
1.30	3			1534SU03-0130	4	47	4.9	6.1	36.6	●
1.35	3			1534SU03-0135	4	47	5.1	6.3	36.5	○
1.40	3			1534SU03-0140	4	47	5.3	6.6	36.3	●
1.45	3			1534SU03-0145	4	47	5.4	6.8	36.2	○
1.47	3			1534SU03-0147	4	47	5.5	6.9	36.1	●
1.50	3			1534SU03-0150	4	47	5.6	7.1	36	●
1.55	3			1534SU03-0155	4	47	5.8	7.3	35.8	○
1.60	3			1534SU03-0160	4	47	6.0	7.5	35.7	●
1.65	3			1534SU03-0165	4	47	6.2	7.8	35.5	○
1.70	3			1534SU03-0170	4	47	6.4	8	35.4	●
1.75	3			1534SU03-0175	4	47	6.6	8.2	35.2	●
1.80	3			1534SU03-0180	4	47	6.8	8.5	35	●
1.85	3			1534SU03-0185	4	47	6.9	8.7	34.9	○
1.90	3			1534SU03-0190	4	47	7.1	8.9	34.8	●
1.95	3			1534SU03-0195	4	47	7.3	9.2	34.5	○
2.0	3			1534SU03-0200	6	62	20	14	36	●
	5			1536SU05-0200	6	66	28	23	36	●
2.1	3			1534SU03-0210	6	62	20	14	36	●
	5			1536SU05-0210	6	66	28	23	36	●
2.2	3			1534SU03-0220	6	62	20	14	36	●
	5			1536SU05-0220	6	66	28	23	36	●
2.3	3			1534SU03-0230	6	62	20	14	36	●
	5			1536SU05-0230	6	66	28	23	36	●
2.33	3	1534SU03-0230	3	59	13.8	14	36	●		

Solid carbide drills
Vollhartmetallbohrer

Drilling - Bohren

Solid carbide drills - Vollhartmetallbohrer

Drill diameter Bohrer Ø d ₁ (m7)	Drilling depth Bohrtiefe (L/d1)	Cooling mode Kühlmittel.	Shank Schaft	Type Typ	Basic dimension(mm) · Basis Abmessungen					Grade Sorte				
					Shank diameter Ø Schaftdurchmesser	Overall length Gesamtlänge	Flute length Nutenlänge	effective drill. length Effektive Nutzlänge	Shank length Schaftlänge					
					d ₂ (h6)	l ₁	l ₂	l ₃	l ₄					
2.4	3	External Extern	Straight shank	1534SU03-0240	6	62	20	14	36	●				
	5			1536SU05-0240	6	66	28	23	36	●				
2.5	3			1534SU03-0250	6	62	20	14	36	●				
	5			1536SU05-0250	6	66	28	23	36	●				
2.6	3			1534SU03-0260	6	62	20	14	36	●				
	5			1536SU05-0260	6	66	28	23	36	●				
2.7	3			1534SU03-0270	6	62	20	14	36	●				
	5			1536SU05-0270	6	66	28	23	36	●				
2.8	3			Zylinder- schaft	Zylinder- schaft	1534SU03-0280	6	62	20	14	36	●		
	5					1536SU05-0280	6	66	28	23	36	●		
2.9	3					1534SU03-0290	6	62	20	14	36	●		
	5					1536SU05-0290	6	66	28	23	36	●		
3.0	3					Internal Intern	Weld on shank/ Schaft	1534SU03-0300	6	62	20	14	36	●
	5							1536SU05-0300	6	66	28	23	36	●
	3							1534SU03C-0300	6	62	20	14	36	●
	5							1536SU05C-0300	6	66	28	23	36	●
	3							1634SU03C-0300	6	62	20	14	36	●
	5							1636SU05C-0300	6	62	20	14	36	●
	3							1734SU03C-0300	6	66	28	23	36	●
	5							1736SU05C-0300	6	66	28	23	36	●
	8							1538SU08C-0300	6	72	34	29	36	●
	3							1534SU03-0310	6	62	20	14	36	●
3.1	5					Internal Intern	Weld on shank/ Schaft	1536SU05-0310	6	66	28	23	36	●
	3							1534SU03C-0310	6	62	20	14	36	●
	5	1536SU05C-0310	6					66	28	23	36	●		
	3	1634SU03C-0310	6					62	20	14	36	●		
	5	1636SU05C-0310	6					66	28	23	36	●		
	3	1734SU03C-0310	6					62	20	14	36	●		
	5	1736SU05C-0310	6					66	28	23	36	●		
	8	1538SU08C-0310	6					72	34	29	36	●		
	3	1534SU03-0320	6					62	20	14	36	●		
	3.2	5	Internal Intern					Weld on shank/ Schaft	1536SU05-0320	6	66	28	23	36
3		1534SU03C-0320		6	62	20	14		36	●				
5		1536SU05C-0320		6	66	28	23		36	●				
3		1634SU03C-0320		6	62	20	14		36	●				
5		1636SU05C-0320		6	66	28	23		36	●				
3		1734SU03C-0320		6	62	20	14		36	●				
5		1736SU05C-0320		6	66	28	23		36	●				
8		1538SU08C-0320		6	72	34	29		36	●				
3		1534SU03-0325		6	62	20	14		36	●				
3.25		5		Internal Intern	Weld on shank/Schaft	1536SU05-0325	6		66	28	23	36	●	
	3	1534SU03C-0325	6			62	20	14	36	●				
	5	1536SU05C-0325	6			66	28	23	36	●				
	3	1634SU03C-0325	6			62	20	14	36	○				
	5	1636SU05C-0325	6			66	28	23	36	○				
	3	1734SU03C-0325	6			62	20	14	36	○				
	5	1736SU05C-0325	6			66	28	23	36	○				

Material Overview · Material Übersicht

✓ = Very suitable · Sehr empfohlen
 ✓ = Suitable · Empfohlen

Type Typ	Grade Sorte	Workpiece material · Werkstückstoff										
		Carbon steel Kohlenstoff - Stahl HB≤180	Alloy steel Legierter Stahl	Hardened steel Gehärteter Stahl			Stainless steel Rostfreier Stahl	Cast iron, Grauguss	Nodular cast iron GGG Kugelgraphitguss	Aluminum alloy Aluleg.	Copper alloy Kupferleg.	Heat resist. alloy Wärmefeste Leg.
				~40HRC	~50HRC	~60HRC						
SU*	KDG303	✓	✓	✓			✓	✓	✓			
SUK*	KDG303							✓	✓			

All articles SUK on demand / Alle Artikel SUK auf Anfrage

Code key C 8
ISO Kennzeichen

Cutting data 96-109
Schnittdaten

Technical Information C110-116
Technische Information

Non-standard tailor made C 117-121
Bestellformular für Sonderwerkzeuge



Drilling · Bohren

Solid carbide drills · Vollhartmetallbohrer

SU&SUK

Please add K when ordering / Bitte bei der Bestellung K ergänzen

General machining · Allgemeine Bearbeitung

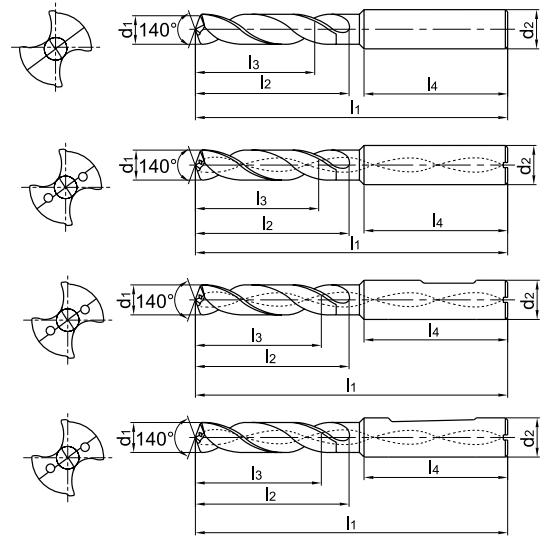
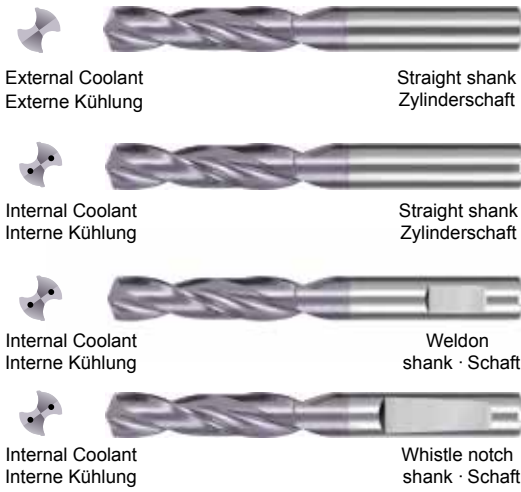

- For high efficient drilling of P (steel), M (stainless steel) and K (cast iron) with high performance.
- Waveform cutting edges achieve outstanding sharpness and strength, promoting chip removal.
- Hocheffizientes Bohren von allgemeinen Stahlwerkstoffen, rostfreien Werkstoffen und Guss.
- Wellenförmige Schneidkante mit hoher Schneidenschärfe, Stabilität und guter Spanabfuhr.

Drill diameter Bohrer Ø d1 (m7)	Drilling depth Bohrtiefe (L/d1)	Cooling mode Kühlmittel.	Shank Schaft	Type Typ	Basic dimension(mm) · Basis Abmessungen					Grade Sorte
					Shank diameter Ø Schaftdurchmesser	Overall length Gesamtlänge	Flute length Nutenlänge	effective drill. length Effektive Nutzlänge	Shank length Schaftlänge	
					d2 (h6)	l1	l2	l3	l4	
3.3	3	External Extern	Straight shank	1534SU03-0330	6	62	20	14	36	●
	5			1536SU05-0330	6	66	28	23	36	●
	3	Internal Intern	Zylinder- schaft	1534SU03C-0330	6	62	20	14	36	●
	5			1536SU05C-0330	6	66	28	23	36	●
	3		Weldon shank/Schaft	1634SU03C-0330	6	62	20	14	36	●
	5			1636SU05C-0330	6	66	28	23	36	●
	3		Whistle notch shank/Schaft	1734SU03C-0330	6	62	20	14	36	●
	5			1736SU05C-0330	6	66	28	23	36	●
8		1538SU08C-0330	6	72	34	29	36	●		
3.4	3	External Extern	Straight shank Zylinder- schaft	1534SU03-0340	6	62	20	14	36	●
	5			1536SU05-0340	6	66	28	23	36	●
	3	Internal Intern	Zylinder- schaft	1534SU03C-0340	6	62	20	14	36	●
	5			1536SU05C-0340	6	66	28	23	36	●
	3		Weldon shank/Schaft	1634SU03C-0340	6	62	20	14	36	●
	5			1636SU05C-0340	6	66	28	23	36	●
	3		Whistle notch shank/Schaft	1734SU03C-0340	6	62	20	14	36	●
	5			1736SU05C-0340	6	66	28	23	36	●
8		1538SU08C-0340	6	72	34	29	36	●		
3.5	3	External Extern	Straight shank	1534SU03-0350	6	62	20	14	36	●
	5			1536SU05-0350	6	66	28	23	36	●
	3	Internal Intern	Zylinder- schaft	1534SU03C-0350	6	62	20	14	36	●
	5			1536SU05C-0350	6	66	28	23	36	●
	3		Weldon shank/Schaft	1634SU03C-0350	6	62	20	14	36	●
	5			1636SU05C-0350	6	66	28	23	36	●
	3		Whistle notch shank/Schaft	1734SU03C-0350	6	62	20	14	36	●
	5			1736SU05C-0350	6	66	28	23	36	●
8		straight shank Zylinderschaft	1538SU08C-0350	6	72	34	29	36	●	

Solid carbide drills
Vollhartmetallbohrer

Drilling - Bohren

Solid carbide drills - Vollhartmetallbohrer

Drill diameter Bohrer Ø d ₁ (m7)	Drilling depth Bohrtiefe (L/d1)	Cooling mode Kühlmittel.	Shank Schaft	Type Typ	Basic dimension(mm) · Basis Abmessungen					Grade Sorte
					Shank diameter Ø Schaftdurchmesser	Overall length Gesamtlänge	Flute length Nutenlänge	effective drill. length Effektive Nutzlänge	Shank length Schaftlänge	
					d ₂ (h6)	l ₁	l ₂	l ₃	l ₄	KDG303
3.6	3	External Extern	Straight shank	1534SU03-0360	6	62	20	14	36	●
	5			1536SU05-0360	6	66	28	23	36	●
	3	Internal Intern	Zylinder- schaft	1534SU03C-0360	6	62	20	14	36	●
	5			1536SU05C-0360	6	66	28	23	36	●
	3	Internal Intern	Weldon shank/Schaft	1634SU03C-0360	6	62	20	14	36	●
	5			1636SU05C-0360	6	66	28	23	36	●
	3		Whistle notch shank/Schaft	1734SU03C-0360	6	62	20	14	36	●
	5			1736SU05C-0360	6	66	28	23	36	●
8		1538SU08C-0360	6	72	34	29	36	●		
3.7	3	External Extern	Straight shank	1534SU03-0370	6	62	20	14	36	●
	5			1536SU05-0370	6	66	28	23	36	●
	3	Internal Intern	Zylinder- schaft	1534SU03C-0370	6	62	20	14	36	●
	5			1536SU05C-0370	6	66	28	23	36	●
	3	Internal Intern	Weldon shank/Schaft	1634SU03C-0370	6	62	20	14	36	●
	5			1636SU05C-0370	6	66	28	23	36	●
	3		Whistle notch shank/Schaft	1734SU03C-0370	6	62	20	14	36	●
	5			1736SU05C-0370	6	66	28	23	36	●
8		1538SU08C-0370	6	72	34	29	36	●		
3.8	3	External Extern	Straight shank	1534SU03-0380	6	66	24	17	36	●
	5			1536SU05-0380	6	74	36	29	36	●
	3	Internal Intern	Zylinder- schaft	1534SU03C-0380	6	66	24	17	36	●
	5			1536SU05C-0380	6	74	36	29	36	●
	3	Internal Intern	Weldon shank/Schaft	1634SU03C-0380	6	66	24	17	36	●
	5			1636SU05C-0380	6	74	36	29	36	●
	3		Whistle notch shank/Schaft	1734SU03C-0380	6	66	24	17	36	●
	5			1736SU05C-0380	6	74	36	29	36	●
8		1538SU08C-0380	6	81	43	36	36	●		
3.9	3	External Extern	Straight shank	1534SU03-0390	6	66	24	17	36	●
	5			1536SU05-0390	6	74	36	29	36	●
	3	Internal Intern	Zylinder- schaft	1534SU03C-0390	6	66	24	17	36	●
	5			1536SU05C-0390	6	74	36	29	36	●
	3	Internal Intern	Weldon shank/Schaft	1634SU03C-0390	6	66	24	17	36	●
	5			1636SU05C-0390	6	74	36	29	36	●
	3		Whistle notch shank/Schaft	1734SU03C-0390	6	66	24	17	36	●
	5			1736SU05C-0390	6	74	36	29	36	●
8		1538SU08C-0390	6	81	43	36	36	●		
4.0	3	External Extern	Straight shank	1534SU03-0400	6	66	24	17	36	●
	5			1536SU05-0400	6	74	36	29	36	●
	3	Internal Intern	Zylinder- schaft	1534SU03C-0400	6	66	24	17	36	●
	5			1536SU05C-0400	6	74	36	29	36	●

Material Overview · Material Übersicht

✓ = Very suitable · Sehr empfohlen
 ✓ = Suitable · Empfohlen

Type Typ	Grade Sorte	Workpiece material · Werkstückstoff									
		Carbon steel Kohlenstoff - Stahl HB≤180	Alloy steel Legierter Stahl	Hardened steel Gehärteter Stahl			Stainless steel Rostfreier Stahl	Cast iron, Grauguss	Nodular cast iron GGG Kugelgra- phitguss	Aluminum alloy Aluleg.	Copper alloy Kupferleg.
				~40HRC	~50HRC	~60HRC					
SU*	KDG303	✓	✓	✓			✓	✓	✓		
SUK*	KDG303							✓	✓		

All articles SUK on demand / Alle Artikel SUK auf Anfrage

Code key C 8
ISO Kennzeichen

Cutting data 96-109
Schnittdaten

Technical Information C110-116
Technische Information

Non-standard tailor made C 117-121
Bestellformular für Sonderwerkzeuge



Drilling · Bohren

Solid carbide drills · Vollhartmetallbohrer

SU&SUK

Please add K when ordering / Bitte bei der Bestellung K ergänzen

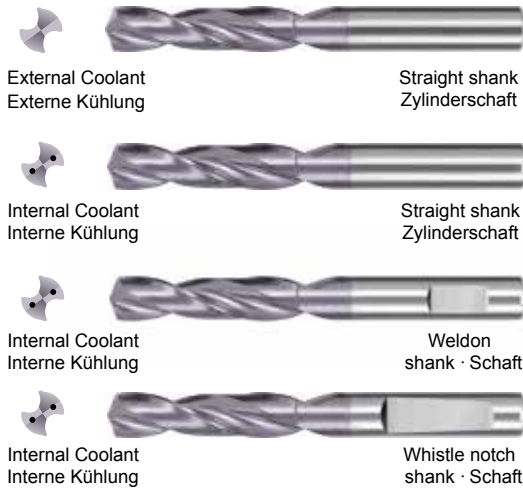

General machining · Allgemeine Bearbeitung

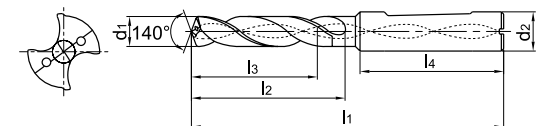
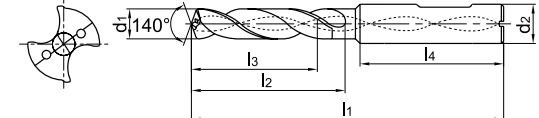
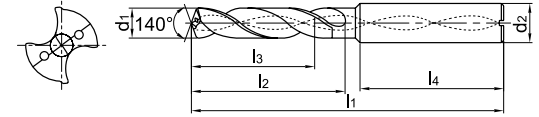
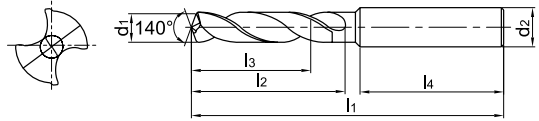

- For high efficient drilling of P (steel), M (stainless steel) and K (cast iron) with high performance.
- Waveform cutting edges achieve outstanding sharpness and strength, promoting chip removal.
- Hocheffizientes Bohren von allgemeinen Stahlwerkstoffen, rostfreien Werkstoffen und Guss.
- Wellenförmige Schneidkante mit hoher Schneidenschärfe, Stabilität und guter Spanabfuhr.

Drill diameter Bohrer Ø d1 (m7)	Drilling depth Bohrtiefe (L/d1)	Cooling mode Kühlmittel.	Shank Schaft	Type Typ	Basic dimension(mm) · Basis Abmessungen					Grade Sorte KDG303			
					Shank diameter Ø Schaftdurchmesser	Overall length Gesamtlänge	Flute length Nutenlänge	effective drill. length Effektive Nutzlänge	Shank length Schaftlänge				
					d2 (h6)	l1	l2	l3	l4				
4.0	3	Internal Intern	Weld on shank/ Schaft	1634SU03C-0400	6	66	24	17	36	●			
	5			1636SU05C-0400	6	74	36	29	36	●			
	3		Whistle notch shank/ Schaft	1734SU03C-0400	6	66	24	17	36	●			
	5			1736SU05C-0400	6	74	36	29	36	●			
	8			1538SU08C-0400	6	81	43	36	36	●			
4.1	3	External Extern	Straight shank Zylinder- schaft	1534SU03-0410	6	66	24	17	36	●			
	5			1536SU05-0410	6	74	36	29	36	●			
	3	Internal Intern	Weld on shank/ Schaft	1634SU03C-0410	6	66	24	17	36	●			
	5			1636SU05C-0410	6	74	36	29	36	●			
	3		Whistle notch shank/ Schaft	1734SU03C-0410	6	66	24	17	36	●			
	5			1736SU05C-0410	6	74	36	29	36	●			
	8			1538SU08C-0410	6	81	43	36	36	●			
	4.2			3	External Extern	Straight shank Zylinder- schaft	1534SU03-0420	6	66	24	17	36	●
				5			1536SU05-0420	6	74	36	29	36	●
				3	Internal Intern	Weld on shank/ Schaft	1634SU03C-0420	6	66	24	17	36	●
5		1636SU05C-0420	6	74			36	29	36	●			
3	Whistle notch shank/ Schaft	1734SU03C-0420	6	66		24	17	36	●				
5		1736SU05C-0420	6	74		36	29	36	●				
8		1538SU08C-0420	6	81		43	36	36	●				
4.3		3	External Extern	Straight shank Zylinder- schaft		1534SU03-0430	6	66	24	17	36	●	
	5	1536SU05-0430			6	74	36	29	36	●			
	3	Internal Intern	Zylinder- schaft	1534SU03C-0430	6	66	24	17	36	●			
	5			1536SU05C-0430	6	74	36	29	36	●			

Solid carbide drills
Vollhartmetallbohrer

Drilling - Bohren

Solid carbide drills - Vollhartmetallbohrer

Drill diameter Bohrer Ø d ₁ (m7)	Drilling depth Bohrtiefe (L/d1)	Cooling mode Kühlmittel.	Shank Schaft	Type Typ	Basic dimension(mm) · Basis Abmessungen					Grade Sorte	
					Shank diameter Ø Schaftdurchmesser	Overall length Gesamtlänge	Flute length Nutenlänge	effective drill. length Effektive Nutzlänge	Shank length Schaftlänge		
					d ₂ (h6)	l ₁	l ₂	l ₃	l ₄	KDG303	
4.3	3	Internal Intern	Weld on shank/Schaft	1634SU03C-0430	6	66	24	17	36	●	
	5			1636SU05C-0430	6	74	36	29	36	●	
	3		Whistle notch shank/Schaft	1734SU03C-0430	6	66	24	17	36	●	
	5			1736SU05C-0430	6	74	36	29	36	●	
	8			1538SU08C-0430	6	81	43	36	36	●	
4.4	3	External Extern	Straight shank	1534SU03-0440	6	66	24	17	36	●	
	5			1536SU05-0440	6	74	36	29	36	●	
	3	Zylinder- schaft	1534SU03C-0440	6	66	24	17	36	●		
	5		1536SU05C-0440	6	74	36	29	36	●		
	3	Internal Intern	Weld on shank/Schaft	1634SU03C-0440	6	66	24	17	36	●	
	5			1636SU05C-0440	6	74	36	29	36	●	
	3		Whistle notch shank/Schaft	1734SU03C-0440	6	66	24	17	36	●	
	5	1736SU05C-0440		6	74	36	29	36	●		
	8	1538SU08C-0440		6	81	43	36	36	●		
	4.5	3	External Extern	Straight shank Zylinder- schaft	1534SU03-0450	6	66	24	17	36	●
5		1536SU05-0450			6	74	36	29	36	●	
3		Internal Intern	Weld on shank/Schaft	1634SU03C-0450	6	66	24	17	36	●	
5				1636SU05C-0450	6	74	36	29	36	●	
3		Whistle notch shank/Schaft	1734SU03C-0450	6	66	24	17	36	●		
5			1736SU05C-0450	6	74	36	29	36	●		
8			1538SU08C-0450	6	81	43	36	36	●		
4.6		3	External Extern	Straight shank Zylinder- schaft	1534SU03-0460	6	66	24	17	36	●
		5			1536SU05-0460	6	74	36	29	36	●
		3	Internal Intern	Weld on shank/Schaft	1634SU03C-0460	6	66	24	17	36	●
	5	1636SU05C-0460			6	74	36	29	36	●	
	3	Whistle notch shank/Schaft	1734SU03C-0460	6	66	24	17	36	●		
	5		1736SU05C-0460	6	74	36	29	36	●		
	8		1538SU08C-0460	6	81	43	36	36	●		
	4.65	3	External Extern	Straight shank Zylinder- schaft	1534SU03-0465	6	66	24	17	36	●
		5			1536SU05-0465	6	74	36	29	36	●
		3	Internal Intern	Weld on shank/Schaft	1634SU03C-0465	6	66	24	17	36	○
5		1636SU05C-0465			6	74	36	29	36	●	
3		Whistle notch shank/Schaft	1734SU03C-0465	6	66	24	17	36	●		
5			1736SU05C-0465	6	74	36	29	36	●		
8			1538SU08C-0465	6	81	43	36	36	●		

Material Overview · Material Übersicht

✓ = Very suitable · Sehr empfohlen
 ✓ = Suitable · Empfohlen

Type Typ	Grade Sorte	Workpiece material · Werkstückstoff									
		Carbon steel Kohlenstoff - Stahl HB≤180	Alloy steel Legierter Stahl	Hardened steel Gehärteter Stahl			Stainless steel Rostfreier Stahl	Cast iron, Grauguss	Nodular cast iron GGG Kugelgra- phitguss	Aluminum alloy Aluleg.	Copper alloy Kupferleg.
SU*	KDG303	✓	✓	✓			✓	✓	✓		
SUK*	KDG303							✓	✓		

All articles SUK on demand / Alle Artikel SUK auf Anfrage

Code key **C 8**
ISO Kennzeichen

Cutting data **96-109**
Schnittdaten

Technical Information **C110-116**
Technische Information

Non-standard tailor made **C 117-121**
Bestellformular für Sonderwerkzeuge



Drilling · Bohren

Solid carbide drills · Vollhartmetallbohrer

SU&SUK

Please add K when ordering / Bitte bei der Bestellung K ergänzen

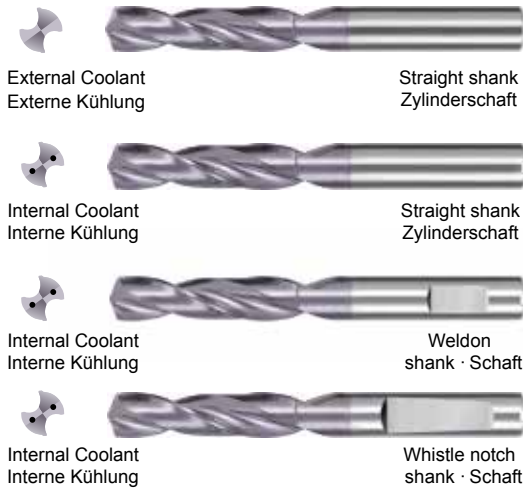

General machining · Allgemeine Bearbeitung

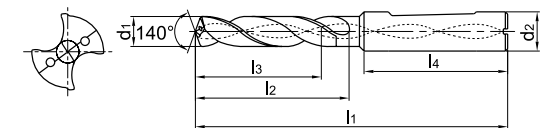
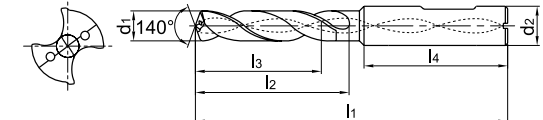
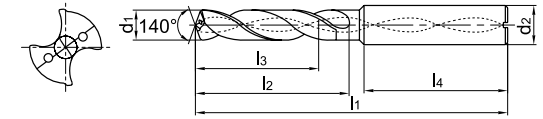
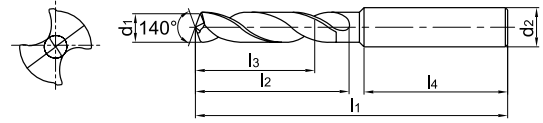

- For high efficient drilling of P (steel), M (stainless steel) and K (cast iron) with high performance.
- Waveform cutting edges achieve outstanding sharpness and strength, promoting chip removal.
- Hocheffizientes Bohren von allgemeinen Stahlwerkstoffen, rostfreien Werkstoffen und Guss.
- Wellenförmige Schneidkante mit hoher Schneidenschärfe, Stabilität und guter Spanabfuhr.

Drill diameter Bohrer Ø d1 (m7)	Drilling depth Bohrtiefe (L/d1)	Cooling mode Kühlmittel.	Shank Schaft	Type Typ	Basic dimension(mm) · Basis Abmessungen					Grade Sorte	
					Shank diameter Ø Schaftdurchmesser	Overall length Gesamtlänge	Flute length Nutenlänge	effective drill. length Effektive Nutzlänge	Shank length Schaftlänge		
					d2 (h6)	l1	l2	l3	l4		KDG303
4.7	3	External Extern	Straight shank	1534SU03-0470	6	66	24	17	36	●	
	5			1536SU05-0470	6	74	36	29	36	●	
	3	Internal Intern	Zylinder- schaft	1534SU03C-0470	6	66	24	17	36	●	
	5			1536SU05C-0470	6	74	36	29	36	●	
	3		Weldon shank/Schaft	1634SU03C-0470	6	66	24	17	36	●	
	5			1636SU05C-0470	6	74	36	29	36	●	
	3			Whistle notch shank/Schaft	1734SU03C-0470	6	66	24	17	36	●
	5				1736SU05C-0470	6	74	36	29	36	●
8	1538SU08C-0470	6	81	43	36	36	●				
4.8	3	External Extern	Straight shank	1534SU03-0480	6	66	28	20	36	●	
	5			1536SU05-0480	6	82	44	35	36	●	
	3	Internal Intern	Zylinder- schaft	1534SU03C-0480	6	66	28	20	36	●	
	5			1536SU05C-0480	6	82	44	35	36	●	
	3		Weldon shank/Schaft	1634SU03C-0480	6	66	28	20	36	●	
	5			1636SU05C-0480	6	82	44	35	36	●	
	3			Whistle notch shank/Schaft	1734SU03C-0480	6	66	28	20	36	●
	5				1736SU05C-0480	6	82	44	35	36	●
8	1538SU08C-0480	6	95	57	48	36	●				
4.9	3	External Extern	Straight shank	1534SU03-0490	6	66	28	20	36	●	
	5			1536SU05-0490	6	82	44	35	36	●	
	3	Internal Intern	Zylinder- schaft	1534SU03C-0490	6	66	28	20	36	●	
	5			1536SU05C-0490	6	82	44	35	36	●	
	3		Weldon shank/Schaft	1634SU03C-0490	6	66	28	20	36	●	
	5			1636SU05C-0490	6	82	44	35	36	●	
	3			Whistle notch shank/Schaft	1734SU03C-0490	6	66	28	20	36	●
	5				1736SU05C-0490	6	82	44	35	36	●
8	1538SU08C-0490	6	95	57	48	36	●				

Solid carbide drills
Vollhartmetallbohrer

Drilling - Bohren

Solid carbide drills - Vollhartmetallbohrer

Drill diameter Bohrer Ø d ₁ (m7)	Drilling depth Bohrtiefe (L/d1)	Cooling mode Kühlmittel.	Shank Schaft	Type Typ	Basic dimension(mm) · Basis Abmessungen					Grade Sorte
					Shank diameter Ø Schaftdurchmesser	Overall length Gesamtlänge	Flute length Nutenlänge	effective drill. length Effektive Nutzlänge	Shank length Schaftlänge	
					d ₂ (h6)	l ₁	l ₂	l ₃	l ₄	KDG303
5.0	3	External Extern	Straight shank	1534SU03-0500	6	66	28	20	36	●
	5			1536SU05-0500	6	82	44	35	36	●
	3		Zylinder- schaft	1534SU03C-0500	6	66	28	20	36	●
	5			1536SU05C-0500	6	82	44	35	36	●
	3	Internal Intern	Weldon shank/ Schaft	1634SU03C-0500	6	66	28	20	36	●
	5			1636SU05C-0500	6	82	44	35	36	●
	3		Whistle notch shank/ Schaft	1734SU03C-0500	6	66	28	20	36	●
	5			1736SU05C-0500	6	82	44	35	36	●
8			1538SU08C-0500	6	95	57	48	36	●	
5.1	3	External Extern	Straight shank	1534SU03-0510	6	66	28	20	36	●
	5			1536SU05-0510	6	82	44	35	36	●
	3		Zylinder- schaft	1534SU03C-0510	6	66	28	20	36	●
	5			1536SU05C-0510	6	82	44	35	36	●
	3	Internal Intern	Weldon shank/ Schaft	1634SU03C-0510	6	66	28	20	36	●
	5			1636SU05C-0510	6	82	44	35	36	●
	3		Whistle notch shank/ Schaft	1734SU03C-0510	6	66	28	20	36	●
	5			1736SU05C-0510	6	82	44	35	36	●
8			1538SU08C-0510	6	95	57	48	36	●	
5.2	3	External Extern	Straight shank	1534SU03-0520	6	66	28	20	36	●
	5			1536SU05-0520	6	82	44	35	36	●
	3		Zylinder- schaft	1534SU03C-0520	6	66	28	20	36	●
	5			1536SU05C-0520	6	82	44	35	36	●
	3	Internal Intern	Weldon shank/ Schaft	1634SU03C-0520	6	66	28	20	36	●
	5			1636SU05C-0520	6	82	44	35	36	●
	3		Whistle notch shank/ Schaft	1734SU03C-0520	6	66	28	20	36	●
	5			1736SU05C-0520	6	82	44	35	36	●
8			1538SU08C-0520	6	95	57	48	36	●	
5.3	3	External Extern	Straight shank	1534SU03-0530	6	66	28	20	36	●
	5			1536SU05-0530	6	82	44	35	36	●
	3		Zylinder- schaft	1534SU03C-0530	6	66	28	20	36	●
	5			1536SU05C-0530	6	82	44	35	36	●
	3	Internal Intern	Weldon shank/ Schaft	1634SU03C-0530	6	66	28	20	36	●
	5			1636SU05C-0530	6	82	44	35	36	●
	3		Whistle notch shank/ Schaft	1734SU03C-0530	6	66	28	20	36	●
	5			1736SU05C-0530	6	82	44	35	36	●
8			1538SU08C-0530	6	95	57	48	36	●	



Solid carbide drills
Vollhartmetallbohrer

Material Overview · Material Übersicht

✓ = Very suitable · Sehr empfohlen
✓ = Suitable · Empfohlen

Type Typ	Grade Sorte	Workpiece material · Werkstückstoff										
		Carbon steel Kohlenstoff - Stahl HB≤180	Alloy steel Legierter Stahl	Hardened steel Gehärteter Stahl			Stainless steel Rostfreier Stahl	Cast iron, Grauguss	Nodular cast iron GGG Kugelgra- phitguss	Aluminum alloy Aluleg.	Copper alloy Kupferleg.	Heat resist. alloy Wärmfeste Leg.
				~40HRC	~50HRC	~60HRC						
SU*	KDG303	✓	✓	✓			✓	✓	✓			
SUK*	KDG303							✓	✓			

All articles SUK on demand / Alle Artikel SUK auf Anfrage

Code key C 8
ISO Kennzeichen

Cutting data 96-109
Schnittdaten

Technical Information C110-116
Technische Information

Non-standard tailor made C 117-121
Bestellformular für Sonderwerkzeuge

Drilling · Bohren

Solid carbide drills · Vollhartmetallbohrer

SU&SUK

Please add K when ordering / Bitte bei der Bestellung K ergänzen

General machining · Allgemeine Bearbeitung

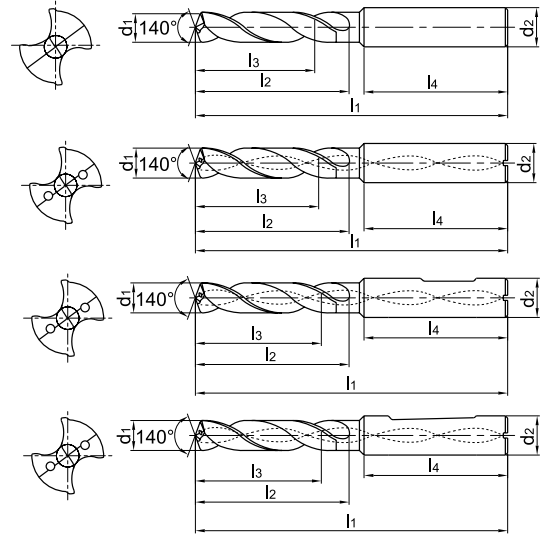
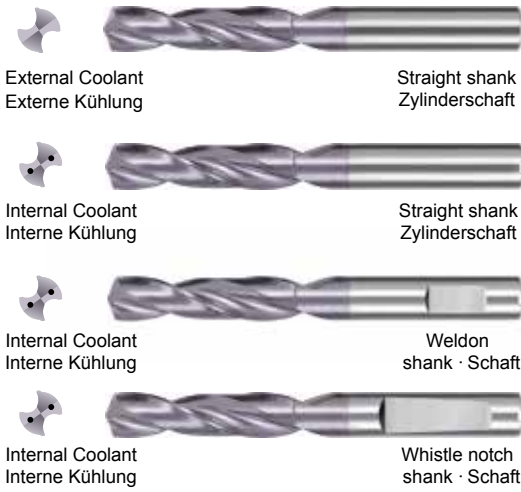

- For high efficient drilling of P (steel), M (stainless steel) and K (cast iron) with high performance.
- Waveform cutting edges achieve outstanding sharpness and strength, promoting chip removal.
- Hocheffizientes Bohren von allgemeinen Stahlwerkstoffen, rostfreien Werkstoffen und Guss.
- Wellenförmige Schneidkante mit hoher Schneidenschärfe, Stabilität und guter Spanabfuhr.

Drill diameter Bohrer Ø d1 (m7)	Drilling depth Bohrtiefe (L/d1)	Cooling mode Kühlmittel.	Shank Schaft	Type Typ	Basic dimension(mm) · Basis Abmessungen					Grade Sorte KDG303
					Shank diameter Ø Schaftdurchmesser	Overall length Gesamtlänge	Flute length Nutenlänge	effective drill. length Effektive Nutzlänge	Shank length Schaftlänge	
					d2 (h6)	l1	l2	l3	l4	
5.4	3	External Extern	Straight shank	1534SU03-0540	6	66	28	20	36	●
	5			1536SU05-0540	6	82	44	35	36	●
	3		Zylinder- schaft	1534SU03C-0540	6	66	28	20	36	●
	5			1536SU05C-0540	6	82	44	35	36	●
	3	Internal Intern	Weld on shank/Schaft	1634SU03C-0540	6	66	28	20	36	●
	5			1636SU05C-0540	6	82	44	35	36	●
	3		Whistle notch shank/Schaft	1734SU03C-0540	6	66	28	20	36	●
	5			1736SU05C-0540	6	82	44	35	36	●
8			1538SU08C-0540	6	95	57	48	36	●	
5.5	3	External Extern	Straight shank	1534SU03-0550	6	66	28	20	36	●
	5			1536SU05-0550	6	82	44	35	36	●
	3		Zylinder- schaft	1534SU03C-0550	6	66	28	20	36	●
	5			1536SU05C-0550	6	82	44	35	36	●
	3	Internal Intern	Weld on shank/Schaft	1634SU03C-0550	6	66	28	20	36	●
	5			1636SU05C-0550	6	82	44	35	36	●
	3		Whistle notch shank/Schaft	1734SU03C-0550	6	66	28	20	36	●
	5			1736SU05C-0550	6	82	44	35	36	●
8			1538SU08C-0550	6	95	57	48	36	●	
5.55	3	External Extern	Straight shank	1534SU03-0555	6	66	28	20	36	●
	5			1536SU05-0555	6	82	44	35	36	●
	3		Zylinder- schaft	1534SU03C-0555	6	66	28	20	36	●
	5			1536SU05C-0555	6	82	44	35	36	●
	3	Internal Intern	Weld on shank/Schaft	1634SU03C-0555	6	66	28	20	36	●
	5			1636SU05C-0555	6	82	44	35	36	●
	3		Whistle notch shank/Schaft	1734SU03C-0555	6	66	28	20	36	●
	5			1736SU05C-0555	6	82	44	35	36	●

Solid carbide drills
Vollhartmetallbohrer

Drilling - Bohren

Solid carbide drills - Vollhartmetallbohrer

Drill diameter Bohrer Ø d ₁ (m7)	Drilling depth Bohrtiefe (L/d1)	Cooling mode Kühlmittel.	Shank Schaft	Type Typ	Basic dimension(mm) · Basis Abmessungen					Grade Sorte KDG303
					Shank diameter Ø Schaftdurchmesser	Overall length Gesamtlänge	Flute length Nutenlänge	effective drill. length Effektive Nutzlänge	Shank length Schaftlänge	
					d ₂ (h6)	l ₁	l ₂	l ₃	l ₄	
5.6	3	External Extern	Straight shank	1534SU03-0560	6	66	28	20	36	●
	5			1536SU05-0560	6	82	44	35	36	●
	3		Zylinder- schaft	1534SU03C-0560	6	66	28	20	36	●
	5			1536SU05C-0560	6	82	44	35	36	●
	3	Internal Intern	Weldon shank/Schaft	1634SU03C-0560	6	66	28	20	36	●
	5			1636SU05C-0560	6	82	44	35	36	●
	3		Whistle notch shank/Schaft	1734SU03C-0560	6	66	28	20	36	●
	5			1736SU05C-0560	6	82	44	35	36	●
8			1538SU08C-0560	6	95	57	48	36	●	
5.7	3	External Extern	Straight shank	1534SU03-0570	6	66	28	20	36	●
	5			1536SU05-0570	6	82	44	35	36	●
	3		Zylinder- schaft	1534SU03C-0570	6	66	28	20	36	●
	5			1536SU05C-0570	6	82	44	35	36	●
	3	Internal Intern	Weldon shank/Schaft	1634SU03C-0570	6	66	28	20	36	●
	5			1636SU05C-0570	6	82	44	35	36	●
	3		Whistle notch shank/Schaft	1734SU03C-0570	6	66	28	20	36	●
	5			1736SU05C-0570	6	82	44	35	36	●
8			1538SU08C-0570	6	95	57	48	36	●	
5.8	3	External Extern	Straight shank	1534SU03-0580	6	66	28	20	36	●
	5			1536SU05-0580	6	82	44	35	36	●
	3		Zylinder- schaft	1534SU03C-0580	6	66	28	20	36	●
	5			1536SU05C-0580	6	82	44	35	36	●
	3	Internal Intern	Weldon shank/Schaft	1634SU03C-0580	6	66	28	20	36	●
	5			1636SU05C-0580	6	82	44	35	36	●
	3		Whistle notch shank/Schaft	1734SU03C-0580	6	66	28	20	36	●
	5			1736SU05C-0580	6	82	44	35	36	●
8			1538SU08C-0580	6	95	57	48	36	●	
5.9	3	External Extern	Straight shank	1534SU03-0590	6	66	28	20	36	●
	5			1536SU05-0590	6	82	44	35	36	●
	3		Zylinder- schaft	1534SU03C-0590	6	66	28	20	36	●
	5			1536SU05C-0590	6	82	44	35	36	●
	3	Internal Intern	Weldon shank/Schaft	1634SU03C-0590	6	66	28	20	36	●
	5			1636SU05C-0590	6	82	44	35	36	●
	3		Whistle notch shank/Schaft	1734SU03C-0590	6	66	28	20	36	●
	5			1736SU05C-0590	6	82	44	35	36	●
8			1538SU08C-0590	6	95	57	48	36	●	



Solid carbide drills
Vollhartmetallbohrer

Material Overview · Material Übersicht

✓ = Very suitable · Sehr empfohlen
✓ = Suitable · Empfohlen

Type Typ	Grade Sorte	Workpiece material · Werkstückstoff										
		Carbon steel Kohlenstoff - Stahl HB≤180	Alloy steel Legierter Stahl	Hardened steel Gehärteter Stahl			Stainless steel Rostfreier Stahl	Cast iron, Grauguss	Nodular cast iron GGG Kugelgra- phitguss	Aluminum alloy Aluleg.	Copper alloy Kupferleg.	Heat resist. alloy Wärmfeste Leg.
				~40HRC	~50HRC	~60HRC						
SU*	KDG303	✓	✓	✓			✓	✓	✓			
SUK*	KDG303							✓	✓			

All articles SUK on demand / Alle Artikel SUK auf Anfrage

Code key C 8
ISO Kennzeichen

Cutting data 96-109
Schnittdaten

Technical Information C110-116
Technische Information

Non-standard tailor made C 117-121
Bestellformular für Sonderwerkzeuge

Drilling · Bohren

Solid carbide drills · Vollhartmetallbohrer

SU&SUK

Please add K when ordering / Bitte bei der Bestellung K ergänzen

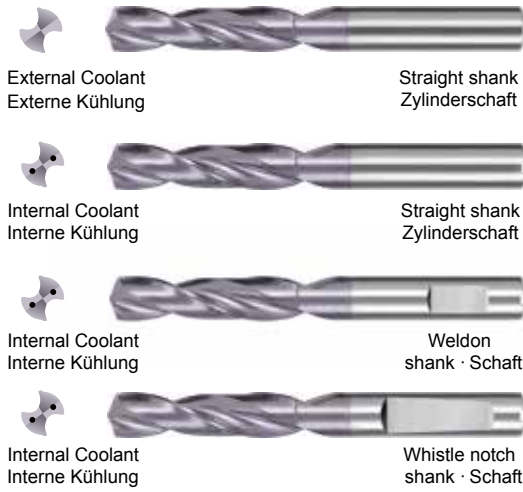

General machining · Allgemeine Bearbeitung

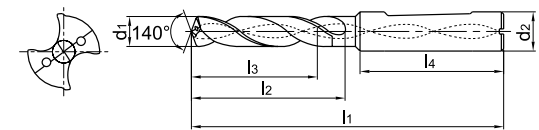
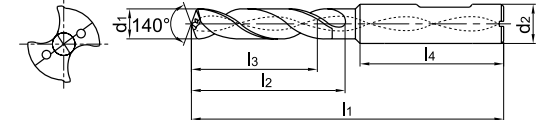
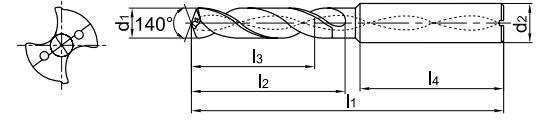
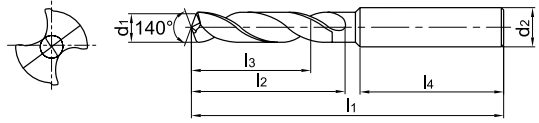

- For high efficient drilling of P (steel), M (stainless steel) and K (cast iron) with high performance.
- Waveform cutting edges achieve outstanding sharpness and strength, promoting chip removal.
- Hocheffizientes Bohren von allgemeinen Stahlwerkstoffen, rostfreien Werkstoffen und Guss.
- Wellenförmige Schneidkante mit hoher Schneidenschärfe, Stabilität und guter Spanabfuhr.

Drill diameter Bohrer Ø d1 (m7)	Drilling depth Bohrtiefe (L/d1)	Cooling mode Kühlmittel.	Shank Schaft	Type Typ	Basic dimension(mm) · Basis Abmessungen					Grade Sorte
					Shank diameter Ø Schaftdurchmesser	Overall length Gesamtlänge	Flute length Nutenlänge	effective drill. length Effektive Nutzlänge	Shank length Schaftlänge	
					d2 (h6)	l1	l2	l3	l4	
6.0	3	External Extern	Straight shank	1534SU03-0600	6	66	28	20	36	●
	5			1536SU05-0600	6	82	44	35	36	●
	3	Internal Intern	Zylinder- schaft	1534SU03C-0600	6	66	28	20	36	●
	5			1536SU05C-0600	6	82	44	35	36	●
	3		Weldon shank/Schaft	1634SU03C-0600	6	66	28	20	36	●
	5			1636SU05C-0600	6	82	44	35	36	●
	3		Whistle notch shank/Schaft	1734SU03C-0600	6	66	28	20	36	●
	5			1736SU05C-0600	6	82	44	35	36	●
8	1538SU08C-0600		6	95	57	48	36	●		
6.1	3		External Extern	Straight shank	1534SU03-0610	8	79	34	24	36
	5	1536SU05-0610			8	91	53	43	36	●
	3	Internal Intern	Zylinder- schaft	1534SU03C-0610	8	79	34	24	36	●
	5			1536SU05C-0610	8	91	53	43	36	●
	3		Weldon shank/Schaft	1634SU03C-0610	8	79	34	24	36	●
	5			1636SU05C-0610	8	91	53	43	36	●
	3		Whistle notch shank/Schaft	1734SU03C-0610	8	79	34	24	36	●
	5			1736SU05C-0610	8	91	53	43	36	●
8	1538SU08C-0610		8	114	76	66	36	●		
6.2	3		External Extern	Straight shank	1534SU03-0620	8	79	34	24	36
	5	1536SU05-0620			8	91	53	43	36	●
	3	Internal Intern	Zylinder- schaft	1534SU03C-0620	8	79	34	24	36	●
	5			1536SU05C-0620	8	91	53	43	36	●
	3		Weldon shank/Schaft	1634SU03C-0620	8	79	34	24	36	●
	5			1636SU05C-0620	8	91	53	43	36	●
	3		Whistle notch shank/Schaft	1734SU03C-0620	8	79	34	24	36	●
	5			1736SU05C-0620	8	91	53	43	36	●
8	straight shank Zylinderschaft		1538SU08C-0620	8	114	76	66	36	●	

Solid carbide drills
Vollhartmetallbohrer

Drilling - Bohren

Solid carbide drills - Vollhartmetallbohrer

Drill diameter Bohrer Ø d ₁ (m7)	Drilling depth Bohrtiefe (L/d1)	Cooling mode Kühlmittel.	Shank Schaft	Type Typ	Basic dimension(mm) · Basis Abmessungen					Grade Sorte
					Shank diameter Ø Schaftdurchmesser	Overall length Gesamtlänge	Flute length Nutenlänge	effective drill. length Effektive Nutzlänge	Shank length Schaftlänge	
					d ₂ (h6)	l ₁	l ₂	l ₃	l ₄	KDG303
6.3	3	External Extern	Straight shank	1534SU03-0630	8	79	34	24	36	●
	5			1536SU05-0630	8	91	53	43	36	●
	3	Internal Intern	Zylinder- schaft	1534SU03C-0630	8	79	34	24	36	●
	5			1536SU05C-0630	8	91	53	43	36	●
	3		Weldon shank/Schaft	1634SU03C-0630	8	79	34	24	36	●
	5			1636SU05C-0630	8	91	53	43	36	●
	3		Whistle notch shank/Schaft	1734SU03C-0630	8	79	34	24	36	●
	5			1736SU05C-0630	8	91	53	43	36	●
8		1538SU08C-0630	8	114	76	66	36	●		
6.4	3	External Extern	Straight shank	1534SU03-0640	8	79	34	24	36	●
	5			1536SU05-0640	8	91	53	43	36	●
	3	Internal Intern	Zylinder- schaft	1534SU03C-0640	8	79	34	24	36	●
	5			1536SU05C-0640	8	91	53	43	36	●
	3		Weldon shank/Schaft	1634SU03C-0640	8	79	34	24	36	●
	5			1636SU05C-0640	8	91	53	43	36	●
	3		Whistle notch shank/Schaft	1734SU03C-0640	8	79	34	24	36	●
	5			1736SU05C-0640	8	91	53	43	36	●
8		1538SU08C-0640	8	114	76	66	36	●		
6.5	3	External Extern	Straight shank	1534SU03-0650	8	79	34	24	36	●
	5			1536SU05-0650	8	91	53	43	36	●
	3	Internal Intern	Zylinder- schaft	1534SU03C-0650	8	79	34	24	36	●
	5			1536SU05C-0650	8	91	53	43	36	●
	3		Weldon shank/Schaft	1634SU03C-0650	8	79	34	24	36	●
	5			1636SU05C-0650	8	91	53	43	36	●
	3		Whistle notch shank/Schaft	1734SU03C-0650	8	79	34	24	36	●
	5			1736SU05C-0650	8	91	53	43	36	●
8		1538SU08C-0650	8	114	76	66	36	●		
6.6	3	External Extern	Straight shank	1534SU03-0660	8	79	34	24	36	●
	5			1536SU05-0660	8	91	53	43	36	●
	3	Internal Intern	Zylinder- schaft	1534SU03C-0660	8	79	34	24	36	●
	5			1536SU05C-0660	8	91	53	43	36	●
	3		Weldon shank/Schaft	1634SU03C-0660	8	79	34	24	36	●
	3			1636SU05C-0660	8	91	53	43	36	●
	5		Whistle notch shank/Schaft	1734SU03C-0660	8	79	34	24	36	●
	5			1736SU05C-0660	8	91	53	43	36	●
8		straight shank Zylinderschaft	1538SU08C-0660	8	114	76	66	36	●	



Solid carbide drills
Vollhartmetallbohrer

Material Overview · Material Übersicht

✓ = Very suitable · Sehr empfohlen
✓ = Suitable · Empfohlen

Type Typ	Grade Sorte	Workpiece material · Werkstückstoff										
		Carbon steel Kohlenstoff - Stahl HB≤180	Alloy steel Legierter Stahl	Hardened steel Gehärteter Stahl			Stainless steel Rostfreier Stahl	Cast iron, Grauguss	Nodular cast iron GGG Kugelgra- phitguss	Aluminum alloy Aluleg.	Copper alloy Kupferleg.	Heat resist. alloy Wärmfeste Leg.
				~40HRC	~50HRC	~60HRC						
SU*	KDG303	✓	✓	✓			✓	✓	✓			
SUK*	KDG303							✓	✓			

All articles SUK on demand / Alle Artikel SUK auf Anfrage

Code key C 8
ISO Kennzeichen

Cutting data 96-109
Schnittdaten

Technical Information C110-116
Technische Information

Non-standard tailor made C 117-121
Bestellformular für Sonderwerkzeuge

Drilling · Bohren

Solid carbide drills · Vollhartmetallbohrer

SU&SUK

Please add K when ordering / Bitte bei der Bestellung K ergänzen

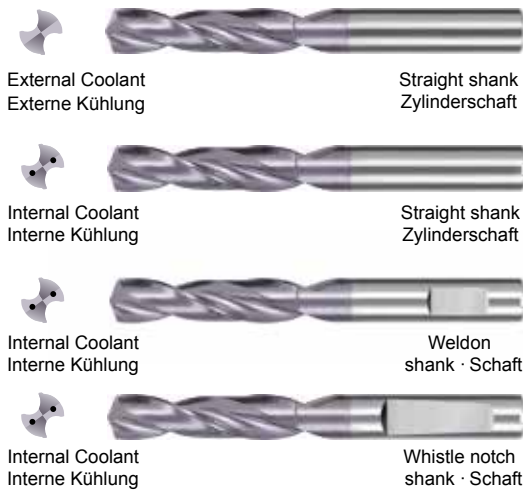

General machining · Allgemeine Bearbeitung

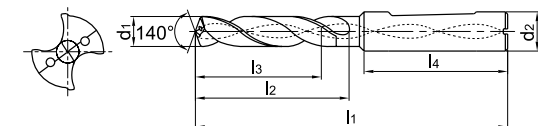
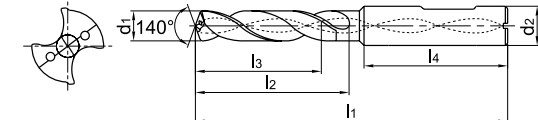
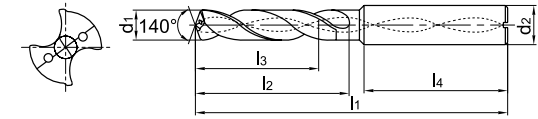
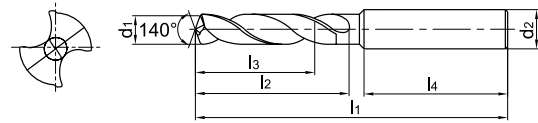

- For high efficient drilling of P (steel), M (stainless steel) and K (cast iron) with high performance.
- Waveform cutting edges achieve outstanding sharpness and strength, promoting chip removal.
- Hocheffizientes Bohren von allgemeinen Stahlwerkstoffen, rostfreien Werkstoffen und Guss.
- Wellenförmige Schneidkante mit hoher Schneidschärfe, Stabilität und guter Spanabfuhr.

Drill diameter Bohrer Ø d1 (m7)	Drilling depth Bohrtiefe (L/d1)	Cooling mode Kühlmittel.	Shank Schaft	Type Typ	Basic dimension(mm) · Basis Abmessungen					Grade Sorte
					Shank diameter Ø Schaftdurchmesser	Overall length Gesamtlänge	Flute length Nutenlänge	effective drill. length Effektive Nutzlänge	Shank length Schaftlänge	
					d2 (h6)	l1	l2	l3	l4	
6.7	3	External Extern	Straight shank Zylinderschaft	1534SU03-0670	8	79	34	24	36	●
	5			1536SU05-0670	8	91	53	43	36	●
	3	Internal Intern	Weldon shank/Schaft	1534SU03C-0670	8	79	34	24	36	●
	5			1536SU05C-0670	8	91	53	43	36	●
	3		Whistle notch shank/Schaft	1634SU03C-0670	8	79	34	24	36	●
	5			1636SU05C-0670	8	91	53	43	36	●
	3			1734SU03C-0670	8	79	34	24	36	●
	5			1736SU05C-0670	8	91	53	43	36	●
8	1538SU08C-0670	8	114	76	66	36	●			
6.75	3	External Extern	Straight shank Zylinderschaft	1534SU03-0675	8	79	34	24	36	●
	5			1536SU05-0675	8	91	53	43	36	●
	3	Internal Intern	Weldon shank/Schaft	1534SU03C-0675	8	79	34	24	36	●
	5			1536SU05C-0675	8	91	53	43	36	●
	3		Whistle notch shank/Schaft	1634SU03C-0675	8	79	34	24	36	○
	5			1636SU05C-0675	8	91	53	43	36	●
	3			1734SU03C-0675	8	79	34	24	36	●
	5			1736SU05C-0675	8	91	53	43	36	○
6.8	3	External Extern	Straight shank Zylinderschaft	1534SU03-0680	8	79	34	24	36	●
	5			1536SU05-0680	8	91	53	43	36	●
	3	Internal Intern	Weldon shank/Schaft	1534SU03C-0680	8	79	34	24	36	●
	5			1536SU05C-0680	8	91	53	43	36	●
	3		Whistle notch shank/Schaft	1634SU03C-0680	8	79	34	24	36	●
	5			1636SU05C-0680	8	91	53	43	36	●
	3			1734SU03C-0680	8	79	34	24	36	●
	5			1736SU05C-0680	8	91	53	43	36	●
	8		1538SU08C-0680	8	114	76	66	36	●	

Solid carbide drills
Vollhartmetallbohrer

Drilling - Bohren

Solid carbide drills - Vollhartmetallbohrer

Drill diameter Bohrer Ø d ₁ (m7)	Drilling depth Bohrtiefe (L/d1)	Cooling mode Kühlmittel.	Shank Schaft	Type Typ	Basic dimension(mm) · Basis Abmessungen					Grade Sorte KDG303
					Shank diameter Ø Schaftdurchmesser	Overall length Gesamtlänge	Flute length Nutenlänge	effective drill. length Effektive Nutzlänge	Shank length Schaftlänge	
					d ₂ (h6)	l ₁	l ₂	l ₃	l ₄	
6.9	3	External Extern	Straight shank	1534SU03-0690	8	79	34	24	36	●
	5			1536SU05-0690	8	91	53	43	36	●
	3	Internal Intern	Zylinder- schaft	1534SU03C-0690	8	79	34	24	36	●
	5			1536SU05C-0690	8	91	53	43	36	●
	3	Internal Intern	Weldon shank/ Schaft	1634SU03C-0690	8	79	34	24	36	●
	5			1636SU05C-0690	8	91	53	43	36	●
	3	Internal Intern	Whistle notch shank/ Schaft	1734SU03C-0690	8	79	34	24	36	●
	5			1736SU05C-0690	8	91	53	43	36	●
8	External Extern	Straight shank	1538SU08C-0690	8	114	76	66	36	●	
3			Internal Intern	Zylinder- schaft	1534SU03-0700	8	79	34	24	36
5	Internal Intern	Weldon shank/ Schaft			1536SU05-0700	8	91	53	43	36
3			Internal Intern	Whistle notch shank/ Schaft	1534SU03C-0700	8	79	34	24	36
5	Internal Intern	Weldon shank/ Schaft			1536SU05C-0700	8	91	53	43	36
3			Internal Intern	Whistle notch shank/ Schaft	1734SU03C-0700	8	79	34	24	36
5	Internal Intern	Weldon shank/ Schaft			1736SU05C-0700	8	91	53	43	36
8			External Extern	Straight shank	1538SU08C-0700	8	116	76	66	36
3	Internal Intern	Zylinder- schaft			1534SU03-0710	8	79	41	29	36
5			Internal Intern	Weldon shank/ Schaft	1536SU05-0710	8	91	53	43	36
3	Internal Intern	Whistle notch shank/ Schaft			1534SU03C-0710	8	79	41	29	36
5			Internal Intern	Weldon shank/ Schaft	1536SU05C-0710	8	91	53	43	36
3	Internal Intern	Whistle notch shank/ Schaft			1734SU03C-0710	8	79	41	29	36
5			Internal Intern	Weldon shank/ Schaft	1736SU05C-0710	8	91	53	43	36
8	External Extern	Straight shank			1538SU08C-0710	8	116	76	66	36
3			Internal Intern	Zylinder- schaft	1534SU03-0720	8	79	41	29	36
5	Internal Intern	Weldon shank/ Schaft			1536SU05-0720	8	91	53	43	36
3			Internal Intern	Whistle notch shank/ Schaft	1534SU03C-0720	8	79	41	29	36
5	Internal Intern	Weldon shank/ Schaft			1536SU05C-0720	8	91	53	43	36
3			Internal Intern	Whistle notch shank/ Schaft	1734SU03C-0720	8	79	41	29	36
5	Internal Intern	Weldon shank/ Schaft			1736SU05C-0720	8	91	53	43	36
8			External Extern	Straight shank	1538SU08C-0720	8	116	76	66	36
3	Internal Intern	Zylinder- schaft			1534SU03-0720	8	79	41	29	36
5			Internal Intern	Weldon shank/ Schaft	1536SU05-0720	8	91	53	43	36
3	Internal Intern	Whistle notch shank/ Schaft			1534SU03C-0720	8	79	41	29	36
5			Internal Intern	Weldon shank/ Schaft	1536SU05C-0720	8	91	53	43	36
3	Internal Intern	Whistle notch shank/ Schaft			1734SU03C-0720	8	79	41	29	36
5			Internal Intern	Weldon shank/ Schaft	1736SU05C-0720	8	91	53	43	36
8	External Extern	Straight shank			1538SU08C-0720	8	116	76	66	36



Solid carbide drills
Vollhartmetallbohrer

Material Overview · Material Übersicht

✓ = Very suitable · Sehr empfohlen
✓ = Suitable · Empfohlen

Type Typ	Grade Sorte	Workpiece material · Werkstückstoff									
		Carbon steel Kohlenstoff - Stahl HB≤180	Alloy steel Legierter Stahl	Hardened steel Gehärteter Stahl			Stainless steel Rostfreier Stahl	Cast iron, Grauguss	Nodular cast iron GGG Kugelgra- phitguss	Aluminum alloy Aluleg.	Copper alloy Kupferleg.
SU*	KDG303	✓	✓	✓			✓	✓	✓		
SUK*	KDG303							✓	✓		

All articles SUK on demand / Alle Artikel SUK auf Anfrage

Code key C 8
ISO Kennzeichen

Cutting data 96-109
Schnittdaten

Technical Information C110-116
Technische Information

Non-standard tailor made C 117-121
Bestellformular für Sonderwerkzeuge

Drilling · Bohren

Solid carbide drills · Vollhartmetallbohrer

SU&SUK

Please add K when ordering / Bitte bei der Bestellung K ergänzen

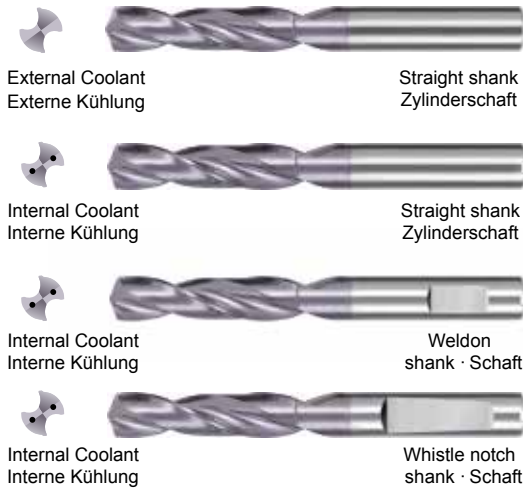

General machining · Allgemeine Bearbeitung

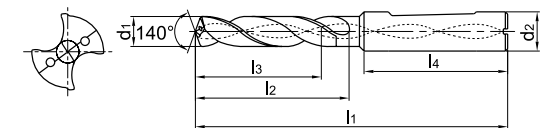
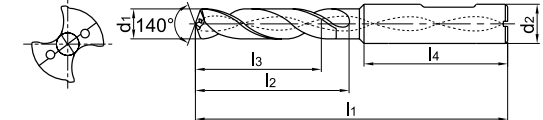
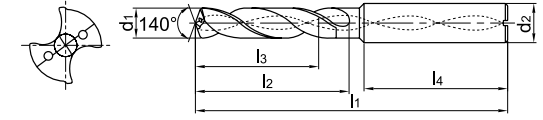
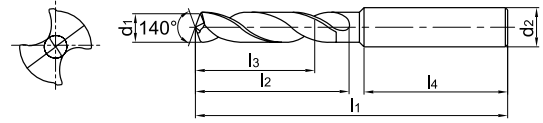

- For high efficient drilling of P (steel), M (stainless steel) and K (cast iron) with high performance.
- Waveform cutting edges achieve outstanding sharpness and strength, promoting chip removal.
- Hocheffizientes Bohren von allgemeinen Stahlwerkstoffen, rostfreien Werkstoffen und Guss.
- Wellenförmige Schneidkante mit hoher Schneidenschärfe, Stabilität und guter Spanabfuhr.

Drill diameter Bohrer Ø d1(m7)	Drilling depth Bohrtiefe (L/d1)	Cooling mode Kühlmittel.	Shank Schaft	Type Typ	Basic dimension(mm) · Basis Abmessungen					Grade Sorte	
					Shank diameter Ø Schaftdurchmesser	Overall length Gesamtlänge	Flute length Nutenlänge	effective drill. length Effektive Nutzlänge	Shank length Schaftlänge		
					d2(h6)	l1	l2	l3	l4		
7.3	3	External Extern	Straight shank	1534SU03-0730	8	79	41	29	36	●	
	5			1536SU05-0730	8	91	53	43	36	●	
	3	Internal Intern	Zylinder- schaft	1534SU03C-0730	8	79	41	29	36	●	
	5			1536SU05C-0730	8	91	53	43	36	●	
	3		Weldon shank/Schaft	1634SU03C-0730	8	79	41	29	36	●	
	5			1636SU05C-0730	8	91	53	43	36	●	
	3			Whistle notch shank/Schaft	1734SU03C-0730	8	79	41	29	36	●
	5				1736SU05C-0730	8	91	53	43	36	●
8	1538SU08C-0730	8	116	76	66	36	●				
7.4	3	External Extern	Straight shank	1534SU03-0740	8	79	41	29	36	●	
	5			1536SU05-0740	8	91	53	43	36	●	
	3	Internal Intern	Zylinder- schaft	1534SU03C-0740	8	79	41	29	36	●	
	5			1536SU05C-0740	8	91	53	43	36	●	
	3		Weldon shank/Schaft	1634SU03C-0740	8	79	41	29	36	●	
	5			1636SU05C-0740	8	91	53	43	36	●	
	3			Whistle notch shank/Schaft	1734SU03C-0740	8	79	41	29	36	●
	5				1736SU05C-0740	8	91	53	43	36	●
8	1538SU08C-0740	8	116	76	66	36	●				
7.45	3	External Extern	Straight shank	1534SU03-0745	8	79	41	29	36	○	
	5			1536SU05-0745	8	91	53	43	36	○	
	3	Internal Intern	Zylinder- schaft	1534SU03C-0745	8	79	41	29	36	○	
	5			1536SU05C-0745	8	91	53	43	36	○	
	3		Weldon shank/Schaft	1634SU03C-0745	8	79	41	29	36	○	
	5			1636SU05C-0745	8	91	53	43	36	○	
	3			Whistle notch shank/Schaft	1734SU03C-0745	8	79	41	29	36	○
	5				1736SU05C-0745	8	91	53	43	36	○
7.5	3	External Extern	Straight shank Zylinderschaft	1534SU03-0750	8	79	41	29	36	●	
	5			1536SU05-0750	8	91	53	43	36	●	

Solid carbide drills
Vollhartmetallbohrer

Drilling - Bohren

Solid carbide drills - Vollhartmetallbohrer

Drill diameter Bohrer Ø d ₁ (m7)	Drilling depth Bohrtiefe (L/d1)	Cooling mode Kühlmittel.	Shank Schaft	Type Typ	Basic dimension(mm) · Basis Abmessungen					Grade Sorte	
					Shank diameter Ø Schaftdurchmesser	Overall length Gesamtlänge	Flute length Nutenlänge	effective drill. length Effektive Nutzlänge	Shank length Schaftlänge		
					d ₂ (h6)	l ₁	l ₂	l ₃	l ₄	KDG303	
7.5	3	Internal Intern	Straight shank Zylinderschaft	1534SU03C-0750	8	79	41	29	36	●	
	5			1536SU05C-0750	8	91	53	43	36	●	
	3		Weldon shank/ Schaft	1634SU03C-0750	8	79	41	29	36	●	
	5			1636SU05C-0750	8	91	53	43	36	●	
	3		Whistle notch shank/ Schaft	1734SU03C-0750	8	79	41	29	36	●	
	5			1736SU05C-0750	8	91	53	43	36	●	
	8			1538SU08C-0750	8	116	76	66	36	●	
7.6	3	External Extern	Straight shank Zylinder- schaft	1534SU03-0760	8	79	41	29	36	●	
	5			1536SU05-0760	8	91	53	43	36	●	
	3	Internal Intern	Weldon shank/ Schaft	1634SU03C-0760	8	79	41	29	36	●	
	5			1636SU05C-0760	8	91	53	43	36	●	
	3	Whistle notch shank/ Schaft	1734SU03C-0760	8	79	41	29	36	●		
	5		1736SU05C-0760	8	91	53	43	36	●		
	8		1538SU08C-0760	8	116	76	66	36	●		
	7.7	3	External Extern	Straight shank Zylinder- schaft	1534SU03-0770	8	79	41	29	36	●
		5			1536SU05-0770	8	91	53	43	36	●
		3	Internal Intern	Weldon shank/ Schaft	1634SU03C-0770	8	79	41	29	36	●
5		1636SU05C-0770			8	91	53	43	36	●	
3		Whistle notch shank/ Schaft	1734SU03C-0770	8	79	41	29	36	●		
5			1736SU05C-0770	8	91	53	43	36	●		
8			1538SU08C-0770	8	116	76	66	36	●		
7.8		3	External Extern	Straight shank Zylinder- schaft	1534SU03-0780	8	79	41	29	36	●
		5			1536SU05-0780	8	91	53	43	36	●
		3	Internal Intern	Weldon shank/ Schaft	1634SU03C-0780	8	79	41	29	36	●
	5	1636SU05C-0780			8	91	53	43	36	●	
	3	Whistle notch shank/ Schaft	1734SU03C-0780	8	79	41	29	36	●		
	5		1736SU05C-0780	8	91	53	43	36	●		
	8		1538SU08C-0780	8	116	76	66	36	●		
	7.9	3	External Extern	Straight shank Zylinder- schaft	1534SU03-0790	8	79	41	29	36	●
		5			1536SU05-0790	8	91	53	43	36	●
		3	Internal Intern	Weldon shank/ Schaft	1634SU03C-0790	8	79	41	29	36	●
5		1636SU05C-0790			8	91	53	43	36	●	

Material Overview · Material Übersicht

✓ = Very suitable · Sehr empfohlen
 ✓ = Suitable · Empfohlen

Type Typ	Grade Sorte	Workpiece material · Werkstückstoff									
		Carbon steel Kohlenstoff - Stahl HB≤180	Alloy steel Legierter Stahl	Hardened steel Gehärteter Stahl			Stainless steel Rostfreier Stahl	Cast iron, Grauguss	Nodular cast iron GGG Kugelgra- phitguss	Aluminum alloy Aluleg.	Copper alloy Kupferleg.
SU*	KDG303	✓	✓	✓			✓	✓	✓		
SUK*	KDG303							✓	✓		

All articles SUK on demand / Alle Artikel SUK auf Anfrage

Code key C 8
ISO Kennzeichen

Cutting data 96-109
Schnittdaten

Technical Information C110-116
Technische Information

Non-standard tailor made C 117-121
Bestellformular für Sonderwerkzeuge



Solid carbide drills
Vollhartmetallbohrer

Drilling · Bohren

Solid carbide drills · Vollhartmetallbohrer

SU&SUK

Please add K when ordering / Bitte bei der Bestellung K ergänzen

General machining · Allgemeine Bearbeitung

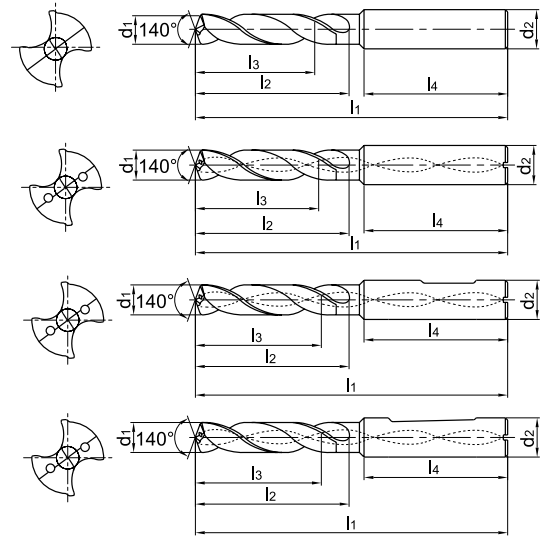
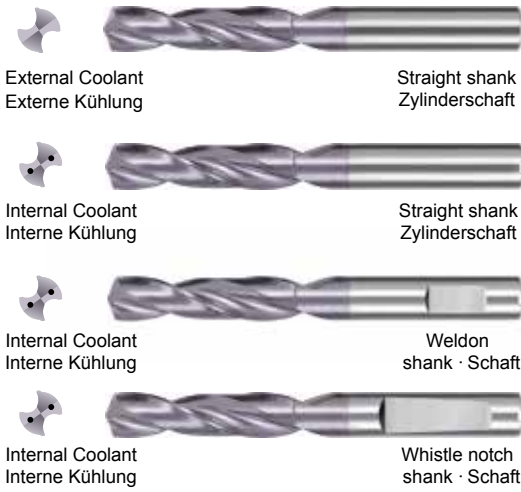

- For high efficient drilling of P (steel), M (stainless steel) and K (cast iron) with high performance.
- Waveform cutting edges achieve outstanding sharpness and strength, promoting chip removal.
- Hocheffizientes Bohren von allgemeinen Stahlwerkstoffen, rostfreien Werkstoffen und Guss.
- Wellenförmige Schneidkante mit hoher Schneidenschärfe, Stabilität und guter Spanabfuhr.

Drill diameter Bohrer Ø d1 (m7)	Drilling depth Bohrtiefe (L/d1)	Cooling mode Kühlmittel.	Shank Schaft	Type Typ	Basic dimension(mm) · Basis Abmessungen					Grade Sorte	
					Shank diameter Ø Schaftdurchmesser	Overall length Gesamtlänge	Flute length Nutenlänge	effective drill. length Effektive Nutzlänge	Shank length Schaftlänge		
					d2 (h6)	l1	l2	l3	l4		
7.9	3	Internal Intern	Whistle notch shank/ Schaft	1734SU03C-0790	8	79	41	29	36	●	
	5			1736SU05C-0790	8	91	53	43	36	●	
	8			1538SU08C-0790	8	116	76	66	36	●	
8.0	3	External Extern	Straight shank Zylinder- schaft	1534SU03-0800	8	79	41	29	36	●	
	5			1536SU05-0800	8	91	53	43	36	●	
	3	Internal Intern	Weld on shank/ Schaft	1534SU03C-0800	8	79	41	29	36	●	
	5			1536SU05C-0800	8	91	53	43	36	●	
	3			Whistle notch shank/ Schaft	1734SU03C-0800	8	79	41	29	36	●
	5				1736SU05C-0800	8	91	53	43	36	●
8	1538SU08C-0800	8	116	76	66	36	●				
8.1	3	External Extern	Straight shank Zylinder- schaft	1534SU03-0810	10	89	47	35	40	●	
	5			1536SU05-0810	10	103	61	49	40	●	
	3	Internal Intern	Weld on shank/ Schaft	1534SU03C-0810	10	89	47	35	40	●	
	5			1536SU05C-0810	10	103	61	49	40	●	
	3			Whistle notch shank/ Schaft	1634SU03C-0810	10	89	47	35	40	●
	5				1636SU05C-0810	10	103	61	49	40	●
	8	1538SU08C-0810	10	142	95	83	40	●			
	8.2	3	External Extern	Straight shank Zylinder- schaft	1534SU03-0820	10	89	47	35	40	●
		5			1536SU05-0820	10	103	61	49	40	●
		3	Internal Intern	Weld on shank/ Schaft	1534SU03C-0820	10	89	47	35	40	●
5		1536SU05C-0820			10	103	61	49	40	●	
3		1634SU03C-0820			10	89	47	35	40	●	
5		1636SU05C-0820	10	103	61	49	40	●			

Solid carbide drills
Vollhartmetallbohrer

Drilling - Bohren

Solid carbide drills - Vollhartmetallbohrer

Drill diameter Bohrer Ø d ₁ (m7)	Drilling depth Bohrtiefe (L/d1)	Cooling mode Kühlmittel.	Shank Schaft	Type Typ	Basic dimension(mm) · Basis Abmessungen					Grade Sorte
					Shank diameter Ø Schaftdurchmesser	Overall length Gesamtlänge	Flute length Nutenlänge	effective drill. length Effektive Nutzlänge	Shank length Schaftlänge	
					d ₂ (h6)	l ₁	l ₂	l ₃	l ₄	KDG303
8.2	3	Internal Intern	Whistle notch shank/Schaft	1734SU03C-0820	10	89	47	35	40	●
	5			1736SU05C-0820	10	103	61	49	40	●
	8			1538SU08C-0820	10	142	95	83	40	●
8.3	3	External Extern	Straight shank Zylinder- schaft	1534SU03-0830	10	89	47	35	40	●
	5			1536SU05-0830	10	103	61	49	40	●
	3			1534SU03C-0830	10	89	47	35	40	●
	5	1536SU05C-0830	10	103	61	49	40	●		
	3	Internal Intern	Weldon shank/Schaft	1634SU03C-0830	10	89	47	35	40	●
	5			1636SU05C-0830	10	103	61	49	40	●
	3			1734SU03C-0830	10	89	47	35	40	●
	5	1736SU05C-0830	10	103	61	49	40	●		
	8	1538SU08C-0830	10	142	95	83	40	●		
8.4	3	External Extern	Straight shank Zylinder- schaft	1534SU03-0840	10	89	47	35	40	●
	5			1536SU05-0840	10	103	61	49	40	●
	3			1534SU03C-0840	10	89	47	35	40	●
	5	1536SU05C-0840	10	103	61	49	40	●		
	3	Internal Intern	Weldon shank/Schaft	1634SU03C-0840	10	89	47	35	40	●
	5			1636SU05C-0840	10	103	61	49	40	●
	3			1734SU03C-0840	10	89	47	35	40	●
	5	1736SU05C-0840	10	103	61	49	40	●		
	8	1538SU08C-0840	10	142	95	83	40	●		
8.5	3	External Extern	Straight shank Zylinder- schaft	1534SU03-0850	10	89	47	35	40	●
	5			1536SU05-0850	10	103	61	49	40	●
	3			1534SU03C-0850	10	89	47	35	40	●
	5	1536SU05C-0850	10	103	61	49	40	●		
	3	Internal Intern	Weldon shank/Schaft	1634SU03C-0850	10	89	47	35	40	●
	5			1636SU05C-0850	10	103	61	49	40	●
	3			1734SU03C-0850	10	89	47	35	40	●
	5	1736SU05C-0850	10	103	61	49	40	●		
	8	1538SU08C-0850	10	142	95	83	40	●		
8.6	3	External Extern	Straight shank Zylinder- schaft	1534SU03-0860	10	89	47	35	40	●
	5			1536SU05-0860	10	103	61	49	40	●
	3			1534SU03C-0860	10	89	47	35	40	●
	5	1536SU05C-0860	10	103	61	49	40	●		
	3	Internal Intern	Weldon shank/Schaft	1634SU03C-0860	10	89	47	35	40	●
	5			1636SU05C-0860	10	103	61	49	40	●
	3			1734SU03C-0860	10	89	47	35	40	●
	5	1736SU05C-0860	10	103	61	49	40	●		
	8	1538SU08C-0860	10	142	95	83	40	●		

Material Overview · Material Übersicht

✓ = Very suitable · Sehr empfohlen
 ✓ = Suitable · Empfohlen

Type Typ	Grade Sorte	Workpiece material · Werkstückstoff										
		Carbon steel Kohlenstoff - Stahl HB≤180	Alloy steel Legierter Stahl	Hardened steel Gehärteter Stahl			Stainless steel Rostfreier Stahl	Cast iron, Grauguss	Nodular cast iron GGG Kugelgra- phitguss	Aluminum alloy Aluleg.	Copper alloy Kupferleg.	Heat resist. alloy Wärmefeste Leg.
				~40HRC	~50HRC	~60HRC						
SU*	KDG303	✓	✓	✓			✓	✓	✓			
SUK*	KDG303							✓	✓			

All articles SUK on demand / Alle Artikel SUK auf Anfrage

Code key C 8
ISO Kennzeichen

Cutting data 96-109
Schnittdaten

Technical Information C110-116
Technische Information

Non-standard tailor made C 117-121
Bestellformular für Sonderwerkzeuge



Solid carbide drills
Vollhartmetallbohrer

Drilling · Bohren

Solid carbide drills · Vollhartmetallbohrer

SU&SUK

Please add K when ordering / Bitte bei der Bestellung K ergänzen

General machining · Allgemeine Bearbeitung

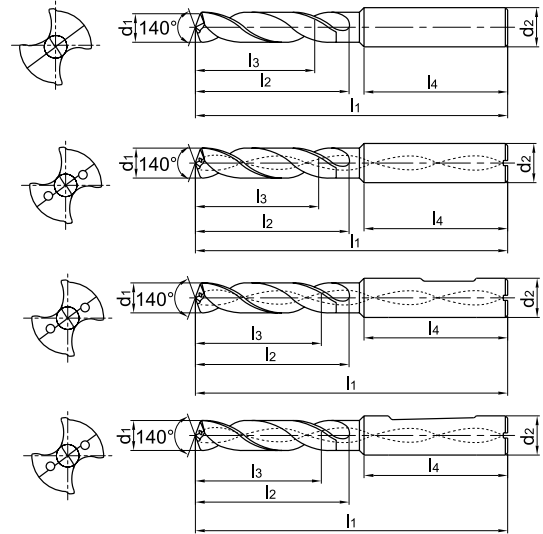
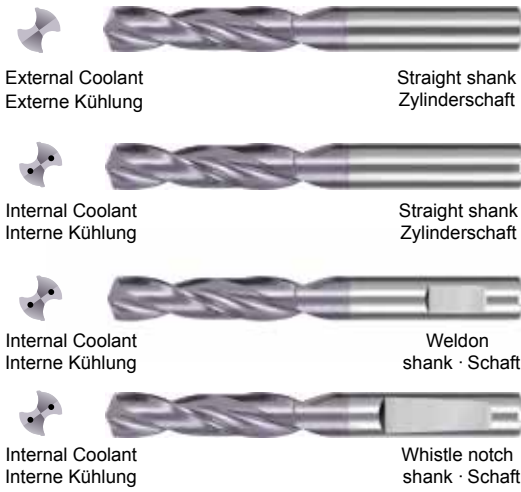

- For high efficient drilling of P (steel), M (stainless steel) and K (cast iron) with high performance.
- Waveform cutting edges achieve outstanding sharpness and strength, promoting chip removal.
- Hocheffizientes Bohren von allgemeinen Stahlwerkstoffen, rostfreien Werkstoffen und Guss.
- Wellenförmige Schneidkante mit hoher Schneidenschärfe, Stabilität und guter Spanabfuhr.

Drill diameter Bohrer Ø d1(m7)	Drilling depth Bohrtiefe (L/d1)	Cooling mode Kühlmittel.	Shank Schaft	Type Typ	Basic dimension(mm) · Basis Abmessungen					Grade Sorte
					Shank diameter Ø Schaftdurchmesser	Overall length Gesamtlänge	Flute length Nutenlänge	effective drill. length Effektive Nutzlänge	Shank length Schaftlänge	
					d2(h6)	l1	l2	l3	l4	
8.7	3	External Extern	Straight shank	1534SU03-0870	10	89	47	35	40	●
	5			1536SU05-0870	10	103	61	49	40	●
	3	Internal Intern	Zylinder- schaft	1534SU03C-0870	10	89	47	35	40	●
	5			1536SU05C-0870	10	103	61	49	40	●
	3		Weld on shank/ Schaft	1634SU03C-0870	10	89	47	35	40	●
	5			1636SU05C-0870	10	103	61	49	40	●
	3		Whistle notch shank/ Schaft	1734SU03C-0870	10	89	47	35	40	●
	5			1736SU05C-0870	10	103	61	49	40	●
8		1538SU08C-0870	10	142	95	83	40	●		
8.8	3	External Extern	Straight shank	1534SU03-0880	10	89	47	35	40	●
	5			1536SU05-0880	10	103	61	49	40	●
	3	Internal Intern	Zylinder- schaft	1534SU03C-0880	10	89	47	35	40	●
	5			1536SU05C-0880	10	103	61	49	40	●
	3		Weld on shank/ Schaft	1634SU03C-0880	10	89	47	35	40	●
	5			1636SU05C-0880	10	103	61	49	40	●
	3		Whistle notch shank/ Schaft	1734SU03C-0880	10	89	47	35	40	●
	5			1736SU05C-0880	10	103	61	49	40	●
8		1538SU08C-0880	10	142	95	83	40	●		
8.9	3	External Extern	Straight shank	1534SU03-0890	10	89	47	35	40	●
	5			1536SU05-0890	10	103	61	49	40	●
	3	Internal Intern	Zylinder- schaft	1534SU03C-0890	10	89	47	35	40	●
	5			1536SU05C-0890	10	103	61	49	40	●
	3		Weld on shank/ Schaft	1634SU03C-0890	10	89	47	35	40	●
	5			1636SU05C-0890	10	103	61	49	40	●
	3		Whistle notch shank/ Schaft	1734SU03C-0890	10	89	47	35	40	●
	5			1736SU05C-0890	10	103	61	49	40	●
8		straight shank Zylinderschaft	1538SU08C-0890	10	142	95	83	40	●	

Solid carbide drills
Vollhartmetallbohrer

Drilling - Bohren

Solid carbide drills - Vollhartmetallbohrer

Drill diameter Bohrer Ø d ₁ (m7)	Drilling depth Bohrtiefe (L/d1)	Cooling mode Kühlmittel.	Shank Schaft	Type Typ	Basic dimension(mm) · Basis Abmessungen					Grade Sorte
					Shank diameter Ø Schaftdurchmesser	Overall length Gesamtlänge	Flute length Nutenlänge	effective drill. length Effektive Nutzlänge	Shank length Schaftlänge	
					d ₂ (h6)	l ₁	l ₂	l ₃	l ₄	KDG303
9.0	3	External Extern	Straight shank	1534SU03-0900	10	89	47	35	40	●
	5			1536SU05-0900	10	103	61	49	40	●
	3	Internal Intern	Zylinder- schaft	1534SU03C-0900	10	89	47	35	40	●
	5			1536SU05C-0900	10	103	61	49	40	●
	3	Internal Intern	Weldon shank/ Schaft	1634SU03C-0900	10	89	47	35	40	●
	5			1636SU05C-0900	10	103	61	49	40	●
	3	Internal Intern	Whistle notch shank/ Schaft	1734SU03C-0900	10	89	47	35	40	●
	5			1736SU05C-0900	10	103	61	49	40	●
8	External Extern	Straight shank	1538SU08C-0900	10	142	95	83	40	●	
3			Internal Intern	Zylinder- schaft	1534SU03-0910	10	89	47	35	40
5	1536SU05-0910	10			103	61	49	40	●	
9.1	3	External Extern	Zylinder- schaft	1534SU03C-0910	10	89	47	35	40	●
	5			1536SU05C-0910	10	103	61	49	40	●
	3	Internal Intern	Weldon shank/ Schaft	1634SU03C-0910	10	89	47	35	40	●
	5			1636SU05C-0910	10	103	61	49	40	●
	3	Internal Intern	Whistle notch shank/ Schaft	1734SU03C-0910	10	89	47	35	40	●
	5			1736SU05C-0910	10	103	61	49	40	●
	8	External Extern	Straight shank	1538SU08C-0910	10	142	95	83	40	●
	3			Internal Intern	Zylinder- schaft	1534SU03-0920	10	89	47	35
5	1536SU05-0920	10	103			61	49	40	●	
9.2	3	External Extern	Zylinder- schaft	1534SU03C-0920	10	89	47	35	40	●
	5			1536SU05C-0920	10	103	61	49	40	●
	3	Internal Intern	Weldon shank/ Schaft	1634SU03C-0920	10	89	47	35	40	●
	5			1636SU05C-0920	10	103	61	49	40	●
	3	Internal Intern	Whistle notch shank/ Schaft	1734SU03C-0920	10	89	47	35	40	●
	5			1736SU05C-0920	10	103	61	49	40	●
	8	External Extern	Straight shank	1538SU08C-0920	10	142	95	83	40	●
	3			Internal Intern	Zylinder- schaft	1534SU03-0930	10	89	47	35
5	1536SU05-0930	10	103			61	49	40	●	
9.3	3	External Extern	Zylinder- schaft	1534SU03C-0930	10	89	47	35	40	●
	5			1536SU05C-0930	10	103	61	49	40	●
	3	Internal Intern	Weldon shank/ Schaft	1634SU03C-0930	10	89	47	35	40	●
	5			1636SU05C-0930	10	103	61	49	40	●
	3	Internal Intern	Whistle notch shank/ Schaft	1734SU03C-0930	10	89	47	35	40	●
	5			1736SU05C-0930	10	103	61	49	40	●
	8	External Extern	Straight shank	1538SU08C-0930	10	142	95	83	40	●
	3			Internal Intern	Zylinder- schaft	1534SU03-0935	10	89	47	35
5	1536SU05-0935	10	103			61	49	40	●	
9.35	3	External Extern	Zylinder- schaft	1534SU03C-0935	10	89	47	35	40	○
	5			1536SU05C-0935	10	103	61	49	40	○

Material Overview · Material Übersicht

✓ = Very suitable · Sehr empfohlen
 ✓ = Suitable · Empfohlen

Type Typ	Grade Sorte	Workpiece material · Werkstückstoff										
		Carbon steel Kohlenstoff - Stahl HB≤180	Alloy steel Legierter Stahl	Hardened steel Gehärteter Stahl			Stainless steel Rostfreier Stahl	Cast iron, Grauguss	Nodular cast iron GGG Kugelgra- phitguss	Aluminum alloy Aluleg.	Copper alloy Kupferleg.	Heat resist. alloy Wärmfeste Leg.
				~40HRC	~50HRC	~60HRC						
SU*	KDG303	✓	✓	✓			✓	✓	✓			
SUK*	KDG303								✓	✓		

All articles SUK on demand / Alle Artikel SUK auf Anfrage

Code key C 8
ISO Kennzeichen

Cutting data 96-109
Schnittdaten

Technical Information C110-116
Technische Information

Non-standard tailor made C 117-121
Bestellformular für Sonderwerkzeuge



Drilling · Bohren

Solid carbide drills · Vollhartmetallbohrer

SU&SUK

Please add K when ordering / Bitte bei der Bestellung K ergänzen

General machining · Allgemeine Bearbeitung

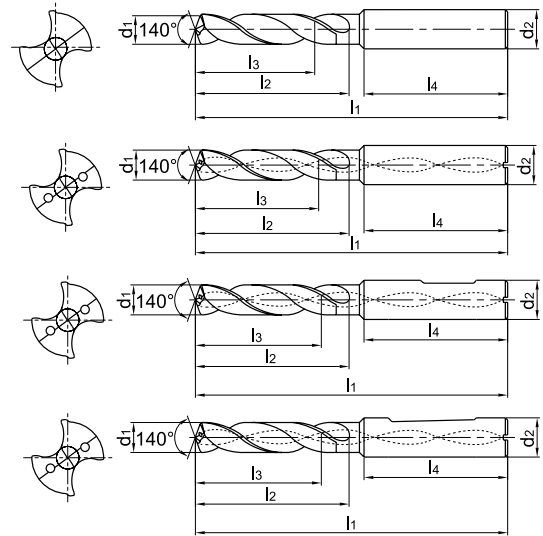
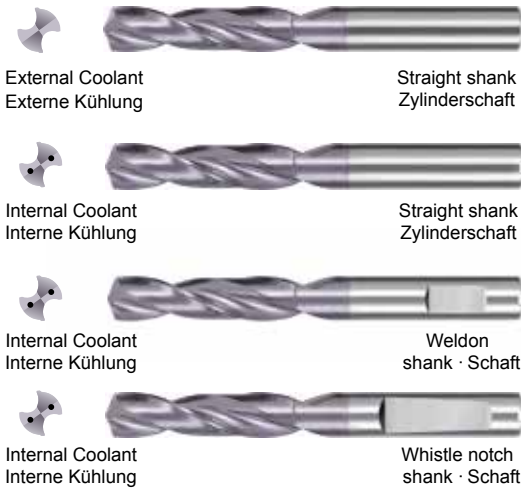

- For high efficient drilling of P (steel), M (stainless steel) and K (cast iron) with high performance.
- Waveform cutting edges achieve outstanding sharpness and strength, promoting chip removal.
- Hocheffizientes Bohren von allgemeinen Stahlwerkstoffen, rostfreien Werkstoffen und Guss.
- Wellenförmige Schneidkante mit hoher Schneidenschärfe, Stabilität und guter Spanabfuhr.

Drill diameter Bohrer Ø d1 (m7)	Drilling depth Bohrtiefe (L/d1)	Cooling mode Kühlmittel.	Shank Schaft	Type Typ	Basic dimension(mm) · Basis Abmessungen					Grade Sorte	
					Shank diameter Ø Schaftdurchmesser	Overall length Gesamtlänge	Flute length Nutenlänge	effective drill. length Effektive Nutzlänge	Shank length Schaftlänge		
					d2 (h6)	l1	l2	l3	l4		
9.35	3	Internal Intern	Weldon shank/ Schaft	1634SU03C-0935	10	89	47	35	40	○	
	5			1636SU05C-0935	10	103	61	49	40	○	
	3		Whistle notch shank/ Schaft	1734SU03C-0935	10	89	47	35	40	○	
	5			1736SU05C-0935	10	103	61	49	40	○	
9.4	3	External Extern	Straight shank	1534SU03-0940	10	89	47	35	40	●	
	5			1536SU05-0940	10	103	61	49	40	●	
	3	Zylinder- schaft	1534SU03C-0940	10	89	47	35	40	●		
	5		1536SU05C-0940	10	103	61	49	40	●		
	3	Internal Intern	Weldon shank/ Schaft	1634SU03C-0940	10	89	47	35	40	●	
	5			1636SU05C-0940	10	103	61	49	40	●	
	3		Whistle notch shank/ Schaft	1734SU03C-0940	10	89	47	35	40	●	
	5			1736SU05C-0940	10	103	61	49	40	●	
	8			1538SU08C-0940	10	142	95	83	40	●	
	9.45	3	External Extern	Straight shank	1534SU03-0945	10	89	47	35	40	○
5		1536SU05-0945			10	103	61	49	40	●	
3		Zylinder- schaft	1534SU03C-0945	10	89	47	35	40	○		
5			1536SU05C-0945	10	103	61	49	40	○		
3		Internal Intern	Weldon shank/ Schaft	1634SU03C-0945	10	89	47	35	40	○	
5				1636SU05C-0945	10	103	61	49	40	○	
3			Whistle notch shank/ Schaft	1734SU03C-0945	10	89	47	35	40	○	
5				1736SU05C-0945	10	103	61	49	40	○	
9.5		3	External Extern	Straight shank	1534SU03-0950	10	89	47	35	40	●
		5			1536SU05-0950	10	103	61	49	40	●
	3	Zylinder- schaft	1534SU03C-0950	10	89	47	35	40	●		
	5		1536SU05C-0950	10	103	61	49	40	●		
	3	Internal Intern	Weldon shank/ Schaft	1634SU03C-0950	10	89	47	35	40	●	
	5			1636SU05C-0950	10	103	61	49	40	●	

Solid carbide drills
Vollhartmetallbohrer

Drilling - Bohren

Solid carbide drills - Vollhartmetallbohrer

Drill diameter Bohrer Ø d ₁ (m7)	Drilling depth Bohrtiefe (L/d1)	Cooling mode Kühlmittel.	Shank Schaft	Type Typ	Basic dimension(mm) · Basis Abmessungen					Grade Sorte
					Shank diameter Ø Schaftdurchmesser	Overall length Gesamtlänge	Flute length Nutenlänge	effective drill. length Effektive Nutzlänge	Shank length Schaftlänge	
					d ₂ (h6)	l ₁	l ₂	l ₃	l ₄	KDG303
9.5	3	Internal Intern	Whistle notch shank/Schaft	1734SU03C-0950	10	89	47	35	40	●
	5			1736SU05C-0950	10	103	61	49	40	●
	8			1538SU08C-0950	10	142	95	83	40	●
9.6	3	External Extern	Straight shank Zylinder- schaft	1534SU03-0960	10	89	47	35	40	●
	5			1536SU05-0960	10	103	61	49	40	●
	3			1534SU03C-0960	10	89	47	35	40	●
	5	1536SU05C-0960	10	103	61	49	40	●		
	3	Internal Intern	Weldon shank/Schaft	1634SU03C-0960	10	89	47	35	40	●
	5			1636SU05C-0960	10	103	61	49	40	●
	3			1734SU03C-0960	10	89	47	35	40	●
	5	1736SU05C-0960	10	103	61	49	40	●		
	8	1538SU08C-0960	10	142	95	83	40	●		
9.7	3	External Extern	Straight shank Zylinder- schaft	1534SU03-0970	10	89	47	35	40	●
	5			1536SU05-0970	10	103	61	49	40	●
	3			1534SU03C-0970	10	89	47	35	40	●
	5	1536SU05C-0970	10	103	61	49	40	●		
	3	Internal Intern	Weldon shank/Schaft	1634SU03C-0970	10	89	47	35	40	●
	5			1636SU05C-0970	10	103	61	49	40	●
	3			1734SU03C-0970	10	89	47	35	40	●
	5	1736SU05C-0970	10	103	61	49	40	●		
	8	1538SU08C-0970	10	142	95	83	40	●		
9.8	3	External Extern	Straight shank Zylinder- schaft	1534SU03-0980	10	89	47	35	40	●
	5			1536SU05-0980	10	103	61	49	40	●
	3			1534SU03C-0980	10	89	47	35	40	●
	5	1536SU05C-0980	10	103	61	49	40	●		
	3	Internal Intern	Weldon shank/Schaft	1634SU03C-0980	10	89	47	35	40	●
	5			1636SU05C-0980	10	103	61	49	40	●
	3			1734SU03C-0980	10	89	47	35	40	●
	5	1736SU05C-0980	10	103	61	49	40	●		
	8	1538SU08C-0980	10	142	95	83	40	●		
9.9	3	External Extern	Straight shank Zylinder- schaft	1534SU03-0990	10	89	47	35	40	●
	5			1536SU05-0990	10	103	61	49	40	●
	3			1534SU03C-0990	10	89	47	35	40	●
	5	1536SU05C-0990	10	103	61	49	40	●		
	3	Internal Intern	Weldon shank/Schaft	1634SU03C-0990	10	89	47	35	40	●
	5			1636SU05C-0990	10	103	61	49	40	●
	3			1734SU03C-0990	10	89	47	35	40	●
	5	1736SU05C-0990	10	103	61	49	40	●		
	8	1538SU08C-0990	10	142	95	83	40	●		

Material Overview · Material Übersicht

✓ = Very suitable · Sehr empfohlen
 ✓ = Suitable · Empfohlen

Type Typ	Grade Sorte	Workpiece material · Werkstückstoff										
		Carbon steel Kohlenstoff - Stahl HB≤180	Alloy steel Legierter Stahl	Hardened steel Gehärteter Stahl			Stainless steel Rostfreier Stahl	Cast iron, Grauguss	Nodular cast iron GGG Kugelgra- phitguss	Aluminum alloy Aluleg.	Copper alloy Kupferleg.	Heat resist. alloy Wärmefeste Leg.
				~40HRC	~50HRC	~60HRC						
SU*	KDG303	✓	✓	✓			✓	✓	✓			
SUK*	KDG303							✓	✓			

All articles SUK on demand / Alle Artikel SUK auf Anfrage

Code key **C 8**
ISO Kennzeichen

Cutting data **96-109**
Schnittdaten

Technical Information **C110-116**
Technische Information

Non-standard tailor made **C 117-121**
Bestellformular für Sonderwerkzeuge



Drilling · Bohren

Solid carbide drills · Vollhartmetallbohrer

SU&SUK

Please add K when ordering / Bitte bei der Bestellung K ergänzen

General machining · Allgemeine Bearbeitung

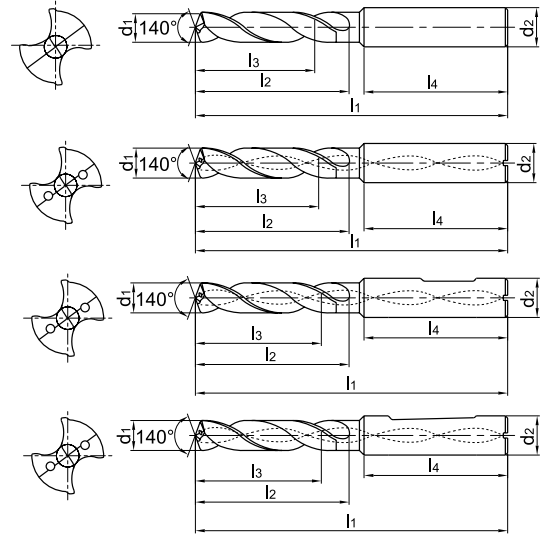
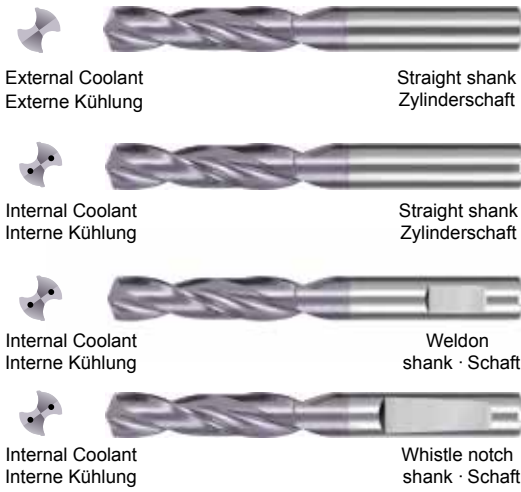

- For high efficient drilling of P (steel), M (stainless steel) and K (cast iron) with high performance.
- Waveform cutting edges achieve outstanding sharpness and strength, promoting chip removal.
- Hocheffizientes Bohren von allgemeinen Stahlwerkstoffen, rostfreien Werkstoffen und Guss.
- Wellenförmige Schneidkante mit hoher Schneidenschärfe, Stabilität und guter Spanabfuhr.

Drill diameter Bohrer Ø d1 (m7)	Drilling depth Bohrtiefe (L/d1)	Cooling mode Kühlmittel.	Shank Schaft	Type Typ	Basic dimension(mm) · Basis Abmessungen					Grade Sorte
					Shank diameter Ø Schaftdurchmesser	Overall length Gesamtlänge	Flute length Nutenlänge	effective drill. length Effektive Nutzlänge	Shank length Schaftlänge	
					d2 (h6)	l1	l2	l3	l4	
10.0	3	External Extern	Straight shank Zylinder- schaft	1534SU03-1000	10	89	47	35	40	●
	5			1536SU05-1000	10	103	61	49	40	●
	3	Internal Intern	Weldon shank/Schaft	1534SU03C-1000	10	89	47	35	40	●
	5			1536SU05C-1000	10	103	61	49	40	●
	3		Whistle notch shank/Schaft	1634SU03C-1000	10	89	47	35	40	●
	5			1636SU05C-1000	10	103	61	49	40	●
	3			1734SU03C-1000	10	89	47	35	40	●
	5			1736SU05C-1000	10	103	61	49	40	●
8	1538SU08C-1000	10	142	95	83	40	●			
10.1	3	External Extern	Straight shank Zylinder- schaft	1534SU03-1010	12	102	55	40	45	●
	5			1536SU05-1010	12	118	71	56	45	●
	3	Internal Intern	Weldon shank/Schaft	1534SU03C-1010	12	102	55	40	45	●
	5			1536SU05C-1010	12	118	71	56	45	●
	3		Whistle notch shank/Schaft	1634SU03C-1010	12	102	55	40	45	●
	5			1636SU05C-1010	12	118	71	56	45	●
	3			1734SU03C-1010	12	102	55	40	45	●
	5			1736SU05C-1010	12	118	71	56	45	●
8	1538SU08C-1010	12	162	114	99	45	●			
10.2	3	External Extern	Straight shank Zylinder- schaft	1534SU03-1020	12	102	55	40	45	●
	5			1536SU05-1020	12	118	71	56	45	●
	3	Internal Intern	Weldon shank/Schaft	1534SU03C-1020	12	102	55	40	45	●
	5			1536SU05C-1020	12	118	71	56	45	●
	3		Whistle notch shank/Schaft	1634SU03C-1020	12	102	55	40	45	●
	5			1636SU05C-1020	12	118	71	56	45	●
	3			1734SU03C-1020	12	102	55	40	45	●
	5			1736SU05C-1020	12	118	71	56	45	●
8	1538SU08C-1020	12	162	114	99	45	●			

Solid carbide drills
Vollhartmetallbohrer

Drilling - Bohren

Solid carbide drills - Vollhartmetallbohrer

Drill diameter Bohrer Ø d ₁ (m7)	Drilling depth Bohrtiefe (L/d1)	Cooling mode Kühlmittel.	Shank Schaft	Type Typ	Basic dimension(mm) · Basis Abmessungen					Grade Sorte
					Shank diameter Ø Schaftdurchmesser	Overall length Gesamtlänge	Flute length Nutenlänge	effective drill. length Effektive Nutzlänge	Shank length Schaftlänge	
					d ₂ (h6)	l ₁	l ₂	l ₃	l ₄	KDG303
10.25	3	External Extern	Straight shank	1534SU03-1025	12	102	55	40	45	●
	5			1536SU05-1025	12	118	71	56	45	●
	3		Zylinder- schaft	1534SU03C-1025	12	102	55	40	45	●
	5			1536SU05C-1025	12	118	71	56	45	●
	3	Internal Intern	Weldon shank/ Schaft	1634SU03C-1025	12	102	55	40	45	●
	5			1636SU05C-1025	12	118	71	56	45	●
	3		Whistle notch shank/ Schaft	1734SU03C-1025	12	102	55	40	45	●
	5			1736SU05C-1025	12	118	71	56	45	●
10.3	3	External Extern	Straight shank	1534SU03-1030	12	102	55	40	45	●
	5			1536SU05-1030	12	118	71	56	45	●
	3		Zylinder- schaft	1534SU03C-1030	12	102	55	40	45	●
	5			1536SU05C-1030	12	118	71	56	45	●
	3	Internal Intern	Weldon shank/ Schaft	1634SU03C-1030	12	102	55	40	45	●
	5			1636SU05C-1030	12	118	71	56	45	●
	3		Whistle notch shank/ Schaft	1734SU03C-1030	12	102	55	40	45	●
	5			1736SU05C-1030	12	118	71	56	45	●
10.4	3	External Extern	Straight shank	1534SU03-1040	12	102	55	40	45	●
	5			1536SU05-1040	12	118	71	56	45	●
	3		Zylinder- schaft	1534SU03C-1040	12	102	55	40	45	●
	5			1536SU05C-1040	12	118	71	56	45	●
	3	Internal Intern	Weldon shank/ Schaft	1634SU03C-1040	12	102	55	40	45	●
	5			1636SU05C-1040	12	118	71	56	45	●
	3		Whistle notch shank/ Schaft	1734SU03C-1040	12	102	55	40	45	●
	5			1736SU05C-1040	12	118	71	56	45	●
8			1538SU08C-1040	12	162	114	99	45	●	
10.5	3	External Extern	Straight shank	1534SU03-1050	12	102	55	40	45	●
	5			1536SU05-1050	12	118	71	56	45	●
	3		Zylinder- schaft	1534SU03C-1050	12	102	55	40	45	●
	5			1536SU05C-1050	12	118	71	56	45	●
	3	Internal Intern	Weldon shank/ Schaft	1634SU03C-1050	12	102	55	40	45	●
	5			1636SU05C-1050	12	118	71	56	45	●
	3		Whistle notch shank/ Schaft	1734SU03C-1050	12	102	55	40	45	●
	5			1736SU05C-1050	12	118	71	56	45	●
8			1538SU08C-1050	12	162	114	99	45	●	
10.6	3	External Extern	Straight shank	1534SU03-1060	12	102	55	40	45	●
	5			1536SU05-1060	12	118	71	56	45	●
	3	Internal Intern	Zylinder- schaft	1534SU03C-1060	12	102	55	40	45	●
	5			1536SU05C-1060	12	118	71	56	45	●



Solid carbide drills
Vollhartmetallbohrer

Material Overview · Material Übersicht

✓ = Very suitable · Sehr empfohlen
✓ = Suitable · Empfohlen

Type Typ	Grade Sorte	Workpiece material · Werkstückstoff										
		Carbon steel Kohlenstoff - Stahl HB≤180	Alloy steel Legierter Stahl	Hardened steel Gehärteter Stahl			Stainless steel Rostfreier Stahl	Cast iron, Grauguss	Nodular cast iron GGG Kugelgra- phitguss	Aluminum alloy Aluleg.	Copper alloy Kupferleg.	Heat resist. alloy Wärmfeste Leg.
				~40HRC	~50HRC	~60HRC						
SU*	KDG303	✓	✓	✓			✓	✓	✓			
SUK*	KDG303								✓	✓		

All articles SUK on demand / Alle Artikel SUK auf Anfrage

Code key C 8
ISO Kennzeichen

Cutting data 96-109
Schnittdaten

Technical Information C110-116
Technische Information

Non-standard tailor made C 117-121
Bestellformular für Sonderwerkzeuge

Drilling · Bohren

Solid carbide drills · Vollhartmetallbohrer

SU&SUK

Please add K when ordering / Bitte bei der Bestellung K ergänzen

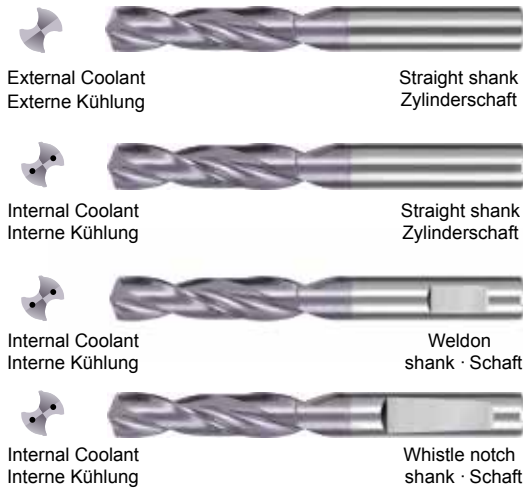

General machining · Allgemeine Bearbeitung

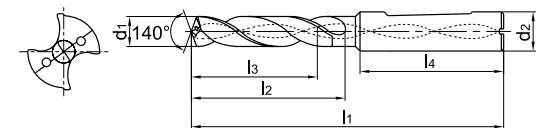
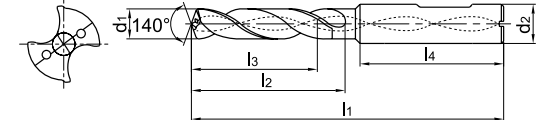
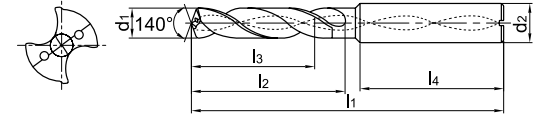
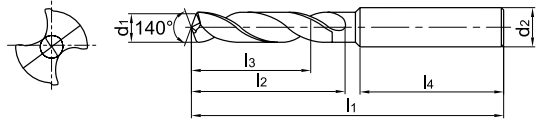

- For high efficient drilling of P (steel), M (stainless steel) and K (cast iron) with high performance.
- Waveform cutting edges achieve outstanding sharpness and strength, promoting chip removal.
- Hocheffizientes Bohren von allgemeinen Stahlwerkstoffen, rostfreien Werkstoffen und Guss.
- Wellenförmige Schneidkante mit hoher Schneidenschärfe, Stabilität und guter Spanabfuhr.

Drill diameter Bohrer Ø d1(m7)	Drilling depth Bohrtiefe (L/d1)	Cooling mode Kühlmittel.	Shank Schaft	Type Typ	Basic dimension(mm) · Basis Abmessungen					Grade Sorte
					Shank diameter Ø Schaftdurchmesser	Overall length Gesamtlänge	Flute length Nutenlänge	effective drill. length Effektive Nutzlänge	Shank length Schaftlänge	
					d2(h6)	l1	l2	l3	l4	
10.6	3	Internal Intern	Weld on shank/ Schaft	1634SU03C-1060	12	102	55	40	45	●
	5			1636SU05C-1060	12	118	71	56	45	●
	3		Whistle notch shank/ Schaft	1734SU03C-1060	12	102	55	40	45	●
	5			1736SU05C-1060	12	118	71	56	45	●
	8			1538SU08C-1060	12	162	114	99	45	●
10.7	3	External Extern	Straight shank Zylinder- schaft	1534SU03-1070	12	102	55	40	45	●
	5			1536SU05-1070	12	118	71	56	45	●
	3			1534SU03C-1070	12	102	55	40	45	●
	5			1536SU05C-1070	12	118	71	56	45	●
	3	Internal Intern	Weld on shank/ Schaft	1634SU03C-1070	12	102	55	40	45	●
	5			1636SU05C-1070	12	118	71	56	45	●
	3		Whistle notch shank/ Schaft	1734SU03C-1070	12	102	55	40	45	●
	5			1736SU05C-1070	12	118	71	56	45	●
	8			1538SU08C-1070	12	162	114	99	45	●
	3			External Extern	Straight shank Zylinder- schaft	1534SU03-1080	12	102	55	40
5	1536SU05-1080	12	118			71	56	45	●	
3	1534SU03C-1080	12	102			55	40	45	●	
5	1536SU05C-1080	12	118			71	56	45	●	
3	Internal Intern	Weld on shank/ Schaft	1634SU03C-1080		12	102	55	40	45	●
5			1636SU05C-1080		12	118	71	56	45	●
3		Whistle notch shank/ Schaft	1734SU03C-1080		12	102	55	40	45	●
5			1736SU05C-1080		12	118	71	56	45	●
8			1538SU08C-1080		12	162	114	99	45	●
3			External Extern		Straight shank Zylinder- schaft	1534SU03-1090	12	102	55	40
5	1536SU05-1090	12		118		71	56	45	●	
3	Internal Intern	Whistle notch shank/ Schaft		1534SU03C-1090	12	102	55	40	45	●
5				1536SU05C-1090	12	118	71	56	45	●

Solid carbide drills
Vollhartmetallbohrer

Drilling - Bohren

Solid carbide drills - Vollhartmetallbohrer

Drill diameter Bohrer Ø d ₁ (m7)	Drilling depth Bohrtiefe (L/d1)	Cooling mode Kühlmittel.	Shank Schaft	Type Typ	Basic dimension(mm) · Basis Abmessungen					Grade Sorte
					Shank diameter Ø Schaftdurchmesser	Overall length Gesamtlänge	Flute length Nutenlänge	effective drill. length Effektive Nutzlänge	Shank length Schaftlänge	
					d ₂ (h6)	l ₁	l ₂	l ₃	l ₄	
10.9	3	Internal Intern	Weldon shank/Schaft	1634SU03C-1090	12	102	55	40	45	●
	5			1636SU05C-1090	12	118	71	56	45	●
	3		Whistle notch shank/Schaft	1734SU03C-1090	12	102	55	40	45	●
	5			1736SU05C-1090	12	118	71	56	45	●
	8			1538SU08C-1090	12	162	114	99	45	●
11.0	3	External Extern	Straight shank	1534SU03-1100	12	102	55	40	45	●
	5			1536SU05-1100	12	118	71	56	45	●
	3		Zylinder- schaft	1534SU03C-1100	12	102	55	40	45	●
	5			1536SU05C-1100	12	118	71	56	45	●
	3	Internal Intern	Weldon shank/Schaft	1634SU03C-1100	12	102	55	40	45	●
	5			1636SU05C-1100	12	118	71	56	45	●
	3		Whistle notch shank/Schaft	1734SU03C-1100	12	102	55	40	45	●
	5			1736SU05C-1100	12	118	71	56	45	●
	8			1538SU08C-1100	12	162	114	99	45	●
	3			External Extern	Straight shank	1534SU03-1110	12	102	55	40
5	1536SU05-1110	12	118			71	56	45	●	
3	Zylinder- schaft	1534SU03C-1110	12		102	55	40	45	●	
5		1536SU05C-1110	12		118	71	56	45	●	
11.1	3	Internal Intern	Weldon shank/Schaft	1634SU03C-1110	12	102	55	40	45	●
	5			1636SU05C-1110	12	118	71	56	45	●
	3		Whistle notch shank/Schaft	1734SU03C-1110	12	102	55	40	45	●
	5			1736SU05C-1110	12	118	71	56	45	●
	8			1538SU08C-1110	12	162	114	99	45	●
	3			External Extern	Straight shank	1534SU03-1120	12	102	55	40
	5	1536SU05-1120	12			118	71	56	45	●
	3	Zylinder- schaft	1534SU03C-1120		12	102	55	40	45	●
	5		1536SU05C-1120		12	118	71	56	45	●
	11.2	3	Internal Intern	Weldon shank/Schaft	1634SU03C-1120	12	102	55	40	45
5		1636SU05C-1120			12	118	71	56	45	●
3		Whistle notch shank/Schaft		1734SU03C-1120	12	102	55	40	45	●
5				1736SU05C-1120	12	118	71	56	45	●
8				1538SU08C-1120	12	162	114	99	45	●
3				External Extern	Straight shank	1534SU03-1125	12	102	55	40
5		1536SU05-1125	12			118	71	56	45	●
3		Zylinder- schaft	1534SU03C-1125		12	102	55	40	45	○
5			1536SU05C-1125		12	118	71	56	45	○
11.25		3	Internal Intern	Weldon shank/Schaft	1634SU03C-1125	12	102	55	40	45
	5	1636SU05C-1125			12	118	71	56	45	○
	3	Whistle notch shank/Schaft		1734SU03C-1125	12	102	55	40	45	○
	5			1736SU05C-1125	12	118	71	56	45	○
	8			1538SU08C-1125	12	162	114	99	45	○

Material Overview · Material Übersicht

✓ = Very suitable · Sehr empfohlen
 ✓ = Suitable · Empfohlen

Type Typ	Grade Sorte	Workpiece material · Werkstückstoff									
		Carbon steel Kohlenstoff - Stahl HB≤180	Alloy steel Legierter Stahl	Hardened steel Gehärteter Stahl			Stainless steel Rostfreier Stahl	Cast iron, Grauguss	Nodular cast iron GGG Kugelgra- phitguss	Aluminum alloy Aluleg.	Copper alloy Kupferleg.
SU*	KDG303	✓	✓	✓			✓	✓	✓		
SUK*	KDG303							✓	✓		

All articles SUK on demand / Alle Artikel SUK auf Anfrage

Code key C 8
ISO Kennzeichen

Cutting data 96-109
Schnittdaten

Technical Information C110-116
Technische Information

Non-standard tailor made C 117-121
Bestellformular für Sonderwerkzeuge



Solid carbide drills
Vollhartmetallbohrer

Drilling · Bohren

Solid carbide drills · Vollhartmetallbohrer

SU&SUK

Please add K when ordering / Bitte bei der Bestellung K ergänzen

General machining · Allgemeine Bearbeitung

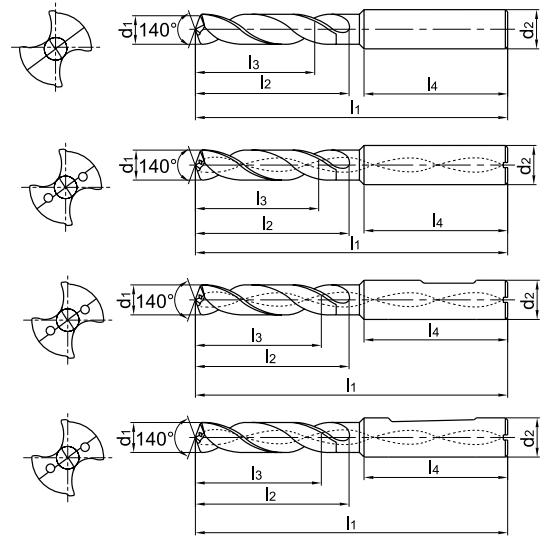
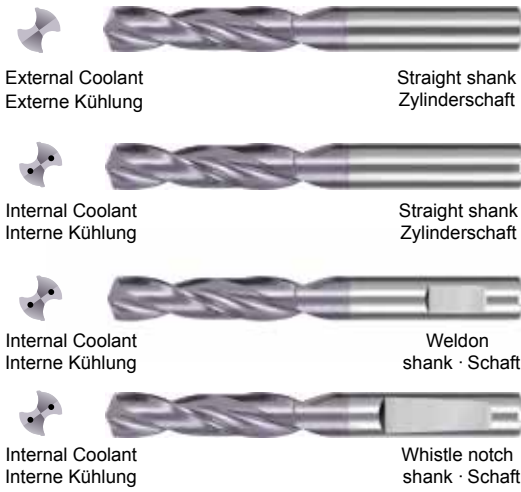

- For high efficient drilling of P (steel), M (stainless steel) and K (cast iron) with high performance.
- Waveform cutting edges achieve outstanding sharpness and strength, promoting chip removal.
- Hocheffizientes Bohren von allgemeinen Stahlwerkstoffen, rostfreien Werkstoffen und Guss.
- Wellenförmige Schneidkante mit hoher Schneidenschärfe, Stabilität und guter Spanabfuhr.

Drill diameter Bohrer Ø d1 (m7)	Drilling depth Bohrtiefe (L/d1)	Cooling mode Kühlmittel.	Shank Schaft	Type Typ	Basic dimension(mm) · Basis Abmessungen					Grade Sorte
					Shank diameter Ø Schaftdurchmesser	Overall length Gesamtlänge	Flute length Nutenlänge	effective drill. length Effektive Nutzlänge	Shank length Schaftlänge	
					d2 (h6)	l1	l2	l3	l4	
11.3	3	External Extern	Straight shank	1534SU03-1130	12	102	55	40	45	●
	5			1536SU05-1130	12	118	71	56	45	●
	3	Internal Intern	Zylinder- schaft	1534SU03C-1130	12	102	55	40	45	●
	5			1536SU05C-1130	12	118	71	56	45	●
	3		Weldon shank/Schaft	1634SU03C-1130	12	102	55	40	45	●
	5			1636SU05C-1130	12	118	71	56	45	●
	3		Whistle notch shank/Schaft	1734SU03C-1130	12	102	55	40	45	●
	5			1736SU05C-1130	12	118	71	56	45	●
8	1538SU08C-1130	12	162	114	99	45	●			
11.35	3	External Extern	Straight shank	1534SU03-1135	12	102	55	40	45	○
	5			1536SU05-1135	12	118	71	56	45	●
	3	Internal Intern	Zylinder- schaft	1534SU03C-1135	12	102	55	40	45	○
	5			1536SU05C-1135	12	118	71	56	45	○
	3		Weldon shank/Schaft	1634SU03C-1135	12	102	55	40	45	○
	5			1636SU05C-1135	12	118	71	56	45	○
	3		Whistle notch shank/Schaft	1734SU03C-1135	12	102	55	40	45	○
	5			1736SU05C-1135	12	118	71	56	45	○
11.4	3	External Extern	Straight shank	1534SU03-1140	12	102	55	40	45	●
	5			1536SU05-1140	12	118	71	56	45	●
	3	Internal Intern	Zylinder- schaft	1534SU03C-1140	12	102	55	40	45	●
	5			1536SU05C-1140	12	118	71	56	45	●
	3		Weldon shank/Schaft	1634SU03C-1140	12	102	55	40	45	●
	5			1636SU05C-1140	12	118	71	56	45	●
	3		Whistle notch shank/Schaft	1734SU03C-1140	12	102	55	40	45	●
	5			1736SU05C-1140	12	118	71	56	45	●
8	1538SU08C-1140	12	162	114	99	45	●			
11.45	3	External Extern	Straight shank Zylinder- schaft	1534SU03-1145	12	102	55	40	45	○
	5			1536SU05-1145	12	118	71	56	45	○

Solid carbide drills
Vollhartmetallbohrer

Drilling - Bohren

Solid carbide drills - Vollhartmetallbohrer

Drill diameter Bohrer Ø d ₁ (m7)	Drilling depth Bohrtiefe (L/d1)	Cooling mode Kühlmittel.	Shank Schaft	Type Typ	Basic dimension(mm) · Basis Abmessungen					Grade Sorte	
					Shank diameter Ø Schaftdurchmesser	Overall length Gesamtlänge	Flute length Nutenlänge	effective drill. length Effektive Nutzlänge	Shank length Schaftlänge		
					d ₂ (h6)	l ₁	l ₂	l ₃	l ₄	KDG303	
11.45	3	Internal Intern	straight shank Zylinderschaft	1534SU03C-1145	12	102	55	40	45	○	
	5			1536SU05C-1145	12	118	71	56	45	○	
	3		Weldon shank/ Schaft	1634SU03C-1145	12	102	55	40	45	○	
	5			1636SU05C-1145	12	118	71	56	45	○	
	3		Whistle notch shank/ Schaft	1734SU03C-1145	12	102	55	40	45	○	
	5			1736SU05C-1145	12	118	71	56	45	○	
11.5	3	External Extern	Straight shank Zylinder- schaft	1534SU03-1150	12	102	55	40	45	●	
	5			1536SU05-1150	12	118	71	56	45	●	
	3			Internal Intern	1634SU03C-1150	12	102	55	40	45	●
	5				1636SU05C-1150	12	118	71	56	45	●
	3	Weldon shank/ Schaft	1734SU03C-1150		12	102	55	40	45	●	
	5		1736SU05C-1150		12	118	71	56	45	●	
	3	Whistle notch shank/ Schaft	1734SU03C-1150	12	102	55	40	45	●		
	5		1736SU05C-1150	12	118	71	56	45	●		
	8		External Extern	1538SU08C-1150	12	162	114	99	45	●	
	3			Straight shank Zylinder- schaft	1534SU03-1160	12	102	55	40	45	●
	5	1536SU05-1160			12	118	71	56	45	●	
	3	Internal Intern			1634SU03C-1160	12	102	55	40	45	●
5	1636SU05C-1160		12		118	71	56	45	●		
3	Weldon shank/ Schaft		1734SU03C-1160	12	102	55	40	45	●		
5			1736SU05C-1160	12	118	71	56	45	●		
3	Whistle notch shank/ Schaft	1734SU03C-1160	12	102	55	40	45	●			
5		1736SU05C-1160	12	118	71	56	45	●			
8		External Extern	1538SU08C-1160	12	162	114	99	45	●		
3			Straight shank Zylinder- schaft	1534SU03-1170	12	102	55	40	45	●	
5	1536SU05-1170			12	118	71	56	45	●		
3	Internal Intern			1634SU03C-1170	12	102	55	40	45	●	
5		1636SU05C-1170		12	118	71	56	45	●		
3		Weldon shank/ Schaft	1734SU03C-1170	12	102	55	40	45	●		
5			1736SU05C-1170	12	118	71	56	45	●		
3	Whistle notch shank/ Schaft	1734SU03C-1170	12	102	55	40	45	●			
5		1736SU05C-1170	12	118	71	56	45	●			
8		External Extern	1538SU08C-1170	12	162	114	99	45	●		
3			Straight shank Zylinder- schaft	1534SU03-1180	12	102	55	40	45	●	
5	1536SU05-1180			12	118	71	56	45	●		
3	Internal Intern			1634SU03C-1180	12	102	55	40	45	●	
5		1636SU05C-1180		12	118	71	56	45	●		
3		Weldon shank/ Schaft	1734SU03C-1180	12	102	55	40	45	●		
5			1736SU05C-1180	12	118	71	56	45	●		



Solid carbide drills
Vollhartmetallbohrer

Material Overview · Material Übersicht

✓ = Very suitable · Sehr empfohlen
✓ = Suitable · Empfohlen

Type Typ	Grade Sorte	Workpiece material · Werkstückstoff										
		Carbon steel Kohlenstoff - Stahl HB≤180	Alloy steel Legierter Stahl	Hardened steel Gehärteter Stahl			Stainless steel Rostfreier Stahl	Cast iron, Grauguss	Nodular cast iron GGG Kugelgra- phitguss	Aluminum alloy Aluleg.	Copper alloy Kupferleg.	Heat resist. alloy Wärmfeste Leg.
				~40HRC	~50HRC	~60HRC						
SU*	KDG303	✓	✓	✓			✓	✓	✓			
SUK*	KDG303							✓	✓			

All articles SUK on demand / Alle Artikel SUK auf Anfrage

Code key C 8
ISO Kennzeichen

Cutting data 96-109
Schnittdaten

Technical Information C110-116
Technische Information

Non-standard tailor made C 117-121
Bestellformular für Sonderwerkzeuge

Drilling · Bohren

Solid carbide drills · Vollhartmetallbohrer

SU&SUK

Please add K when ordering / Bitte bei der Bestellung K ergänzen

General machining · Allgemeine Bearbeitung

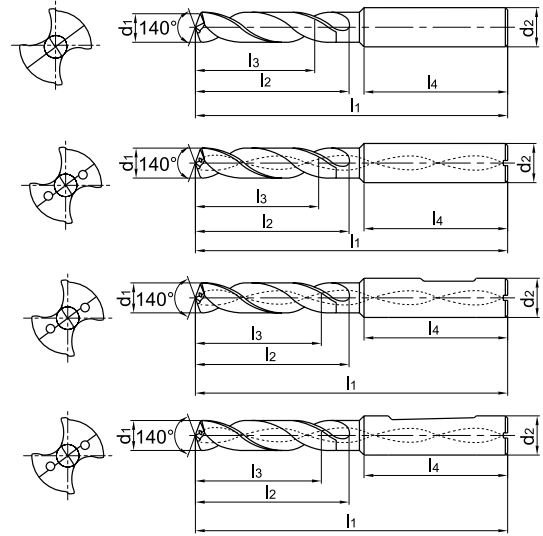
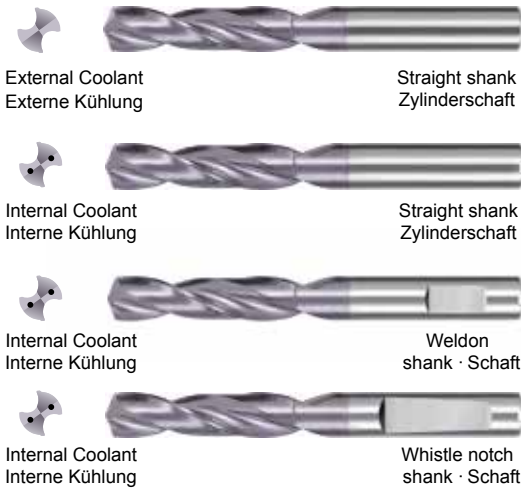

- For high efficient drilling of P (steel), M (stainless steel) and K (cast iron) with high performance.
- Waveform cutting edges achieve outstanding sharpness and strength, promoting chip removal.
- Hocheffizientes Bohren von allgemeinen Stahlwerkstoffen, rostfreien Werkstoffen und Guss.
- Wellenförmige Schneidkante mit hoher Schneidenschärfe, Stabilität und guter Spanabfuhr.

Drill diameter Bohrer Ø d1 (m7)	Drilling depth Bohrtiefe (L/d1)	Cooling mode Kühlmittel.	Shank Schaft	Type Typ	Basic dimension(mm) · Basis Abmessungen					Grade Sorte	
					Shank diameter Ø Schaftdurchmesser	Overall length Gesamtlänge	Flute length Nutenlänge	effective drill. length Effektive Nutzlänge	Shank length Schaftlänge		
					d2 (h6)	l1	l2	l3	l4		
11.8	3	Internal Intern	Whistle notch shank/ Schaft	1734SU03C-1180	12	102	55	40	45	●	
	5			1736SU05C-1180	12	118	71	56	45	●	
	8			1538SU08C-1180	12	162	114	99	45	●	
11.9	3	External Extern	Straight shank Zylinder- schaft	1534SU03-1190	12	102	55	40	45	●	
	5			1536SU05-1190	12	118	71	56	45	●	
	3			1534SU03C-1190	12	102	55	40	45	●	
	5	1536SU05C-1190	12	118	71	56	45	●			
	3	Internal Intern	Weldon shank/ Schaft	1634SU03C-1190	12	102	55	40	45	●	
	5			1636SU05C-1190	12	118	71	56	45	●	
	3			1734SU03C-1190	12	102	55	40	45	●	
	5	Whistle notch shank/ Schaft	1736SU05C-1190	12	118	71	56	45	●		
	8		1538SU08C-1190	12	162	114	99	45	●		
3	External Extern		Straight shank Zylinder- schaft	1534SU03-1200	12	102	55	40	45	●	
5		1536SU05-1200		12	118	71	56	45	●		
3		1534SU03C-1200		12	102	55	40	45	●		
12.0	5	Internal Intern	Weldon shank/ Schaft	1536SU05C-1200	12	118	71	56	45	●	
	3			1634SU03C-1200	12	102	55	40	45	●	
	5			1636SU05C-1200	12	118	71	56	45	●	
	3	Whistle notch shank/ Schaft	1734SU03C-1200	12	102	55	40	45	●		
	5		1736SU05C-1200	12	118	71	56	45	●		
	8		1538SU08C-1200	12	162	114	99	45	●		
	12.1	3	External Extern	Straight shank Zylinder- schaft	1534SU03-1210	14	107	60	43	45	●
		5			1536SU05-1210	14	124	77	60	45	●
		3			1534SU03C-1210	14	107	60	43	45	●
5		Internal Intern	Weldon shank/ Schaft	1536SU05C-1210	14	124	77	60	45	●	
3				1634SU03C-1210	14	107	60	43	45	●	
5				1636SU05C-1210	14	124	77	60	45	●	
3		Whistle notch shank/ Schaft	1734SU03C-1210	14	107	60	43	45	●		
5			1736SU05C-1210	14	124	77	60	45	●		

Solid carbide drills
Vollhartmetallbohrer

Drill diameter Bohrer Ø d ₁ (m7)	Drilling depth Bohrtiefe (L/d1)	Cooling mode Kühlmittel.	Shank Schaft	Type Typ	Basic dimension(mm) · Basis Abmessungen					Grade Sorte
					Shank diameter Ø Schaftdurchmesser	Overall length Gesamtlänge	Flute length Nutenlänge	effective drill. length Effektive Nutzlänge	Shank length Schaftlänge	
					d ₂ (h6)	l ₁	l ₂	l ₃	l ₄	KDG303
12.2	3	External Extern	Straight shank	1534SU03-1220	14	107	60	43	45	●
	5			1536SU05-1220	14	124	77	60	45	●
	3	Internal Intern	Zylinder- schaft	1534SU03C-1220	14	107	60	43	45	●
	5			1536SU05C-1220	14	124	77	60	45	●
	3		Weld on shank/ Schaft	1634SU03C-1220	14	107	60	43	45	●
	5			1636SU05C-1220	14	124	77	60	45	●
	3			Whistle notch shank/ Schaft	1734SU03C-1220	14	107	60	43	45
5	1736SU05C-1220	14	124		77	60	45	●		
12.25	3	External Extern	Straight shank	1534SU03-1225	14	107	60	43	45	●
	5			1536SU05-1225	14	124	77	60	45	●
	3	Internal Intern	Zylinder- schaft	1534SU03C-1225	14	107	60	43	45	●
	5			1536SU05C-1225	14	124	77	60	45	●
	3		Weld on shank/ Schaft	1634SU03C-1225	14	107	60	43	45	○
	5			1636SU05C-1225	14	124	77	60	45	●
	3			Whistle notch shank/ Schaft	1734SU03C-1225	14	107	60	43	45
5	1736SU05C-1225	14	124		77	60	45	○		
12.3	3	External Extern	Straight shank	1534SU03-1230	14	107	60	43	45	●
	5			1536SU05-1230	14	124	77	60	45	●
	3	Internal Intern	Zylinder- schaft	1534SU03C-1230	14	107	60	43	45	●
	5			1536SU05C-1230	14	124	77	60	45	●
	3		Weld on shank/ Schaft	1634SU03C-1230	14	107	60	43	45	●
	5			1636SU05C-1230	14	124	77	60	45	●
	3			Whistle notch shank/ Schaft	1734SU03C-1230	14	107	60	43	45
5	1736SU05C-1230	14	124		77	60	45	●		



Material Overview · Material Übersicht

✓ = Very suitable · Sehr empfohlen
✓ = Suitable · Empfohlen

Type Typ	Grade Sorte	Workpiece material · Werkstückstoff										
		Carbon steel Kohlenstoff - Stahl HB≤180	Alloy steel Legierter Stahl	Hardened steel Gehärteter Stahl			Stainless steel Rostfreier Stahl	Cast iron, Grauguss	Nodular cast iron GGG Kugelgra- phitguss	Aluminum alloy Aluleg.	Copper alloy Kupferleg.	Heat resist. alloy Warmfeste Leg.
				~40HRC	~50HRC	~60HRC						
SU*	KDG303	✓	✓	✓			✓	✓	✓			
SUK*	KDG303							✓	✓			

All articles SUK on demand / Alle Artikel SUK auf Anfrage

Code key C 8
ISO Kennzeichen

Cutting data 96-109
Schnittdaten

Technical Information C110-116
Technische Information

Non-standard tailor made C 117-121
Bestellformular für Sonderwerkzeuge

Drilling · Bohren

Solid carbide drills · Vollhartmetallbohrer

SU&SUK

Please add K when ordering / Bitte bei der Bestellung K ergänzen

General machining · Allgemeine Bearbeitung

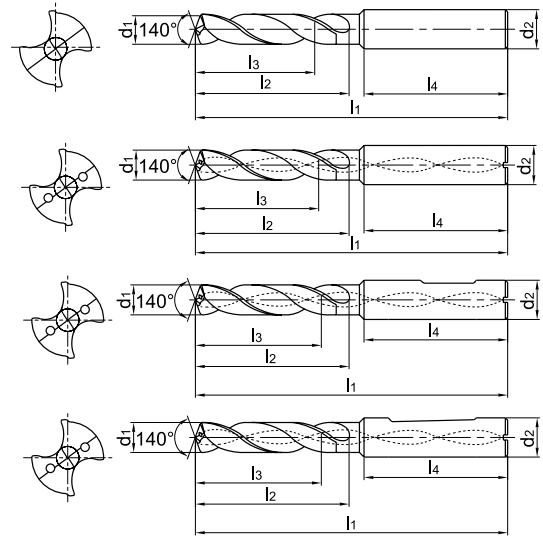
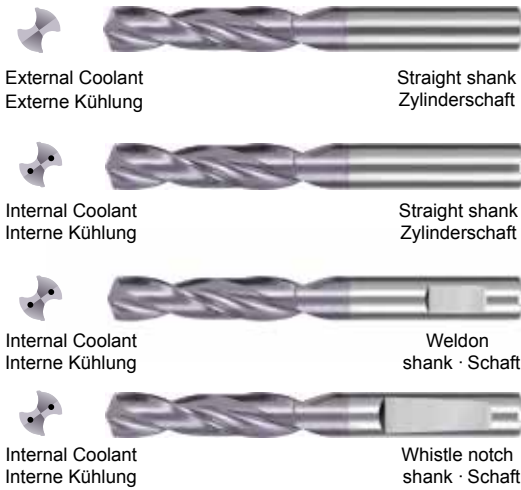

- For high efficient drilling of P (steel), M (stainless steel) and K (cast iron) with high performance.
- Waveform cutting edges achieve outstanding sharpness and strength, promoting chip removal.
- Hocheffizientes Bohren von allgemeinen Stahlwerkstoffen, rostfreien Werkstoffen und Guss.
- Wellenförmige Schneidkante mit hoher Schneidenschärfe, Stabilität und guter Spanabfuhr.

Drill diameter Bohrer Ø d1 (m7)	Drilling depth Bohrtiefe (L/d1)	Cooling mode Kühlmittel.	Shank Schaft	Type Typ	Basic dimension(mm) · Basis Abmessungen					Grade Sorte	
					Shank diameter Ø Schaftdurchmesser	Overall length Gesamtlänge	Flute length Nutenlänge	effective drill. length Effektive Nutzlänge	Shank length Schaftlänge		
					d2 (h6)	l1	l2	l3	l4		
12.5	3	External Extern	Straight shank	1534SU03-1250	14	107	60	43	45	●	
	5			1536SU05-1250	14	124	77	60	45	●	
	3	Internal Intern	Zylinder-schaft	1534SU03C-1250	14	107	60	43	45	●	
	5			1536SU05C-1250	14	124	77	60	45	●	
	3		Weldon shank/Schaft	1634SU03C-1250	14	107	60	43	45	●	
	5			1636SU05C-1250	14	124	77	60	45	●	
	3			Whistle notch shank/Schaft	1734SU03C-1250	14	107	60	43	45	●
	5				1736SU05C-1250	14	124	77	60	45	●
8	1538SU08C-1250	14	178	133	116	45	●				
12.7	3	External Extern	Straight shank	1534SU03-1270	14	107	60	43	45	●	
	5			1536SU05-1270	14	124	77	60	45	●	
	3	Internal Intern	Zylinder-schaft	1534SU03C-1270	14	107	60	43	45	●	
	5			1536SU05C-1270	14	124	77	60	45	●	
	3		Weldon shank/Schaft	1634SU03C-1270	14	107	60	43	45	●	
	5			1636SU05C-1270	14	124	77	60	45	●	
	3			Whistle notch shank/Schaft	1734SU03C-1270	14	107	60	43	45	●
	5				1736SU05C-1270	14	124	77	60	45	●
8	1538SU08C-1270	14	178	133	116	45	●				
12.75	3	External Extern	Straight shank	1534SU03-1275	14	107	60	43	45	●	
	5			1536SU05-1275	14	124	77	60	45	●	
	3	Internal Intern	Zylinder-schaft	1534SU03C-1275	14	107	60	43	45	●	
	5			1536SU05C-1275	14	124	77	60	45	●	
	3		Weldon shank/Schaft	1634SU03C-1275	14	107	60	43	45	○	
	5			1636SU05C-1275	14	124	77	60	45	○	
	3			Weldon shank/Schaft	1734SU03C-1275	14	107	60	43	45	●
	5				1736SU05C-1275	14	124	77	60	45	●

Solid carbide drills
Vollhartmetallbohrer

Drilling - Bohren

Solid carbide drills - Vollhartmetallbohrer

Drill diameter Bohrer Ø d ₁ (m7)	Drilling depth Bohrtiefe (L/d1)	Cooling mode Kühlmittel.	Shank Schaft	Type Typ	Basic dimension(mm) · Basis Abmessungen					Grade Sorte
					Shank diameter Ø Schaftdurchmesser	Overall length Gesamtlänge	Flute length Nutenlänge	effective drill. length Effektive Nutzlänge	Shank length Schaftlänge	
					d ₂ (h6)	l ₁	l ₂	l ₃	l ₄	KDG303
12.8	3	External Extern	Straight shank	1534SU03-1280	14	107	60	43	45	●
	5			1536SU05-1280	14	124	77	60	45	●
	3	Internal Intern	Zylinder- schaft	1534SU03C-1280	14	107	60	43	45	●
	5			1536SU05C-1280	14	124	77	60	45	●
	3	Internal Intern	Weldon shank/ Schaft	1634SU03C-1280	14	107	60	43	45	●
	5			1636SU05C-1280	14	124	77	60	45	●
	3		Whistle notch shank/ Schaft	1734SU03C-1280	14	107	60	43	45	●
	5			1736SU05C-1280	14	124	77	60	45	●
8			1538SU08C-1280	14	178	133	116	45	●	
13.0	3	External Extern	Straight shank	1534SU03-1300	14	107	60	43	45	●
	5			1536SU05-1300	14	124	77	60	45	●
	3	Internal Intern	Zylinder- schaft	1534SU03C-1300	14	107	60	43	45	●
	5			1536SU05C-1300	14	124	77	60	45	●
	3	Internal Intern	Weldon shank/ Schaft	1634SU03C-1300	14	107	60	43	45	●
	5			1636SU05C-1300	14	124	77	60	45	●
	3		Whistle notch shank/ Schaft	1734SU03C-1300	14	107	60	43	45	●
	5			1736SU05C-1300	14	124	77	60	45	●
8			1538SU08C-1300	14	178	133	116	45	●	
13.1	3	External Extern	Straight shank	1534SU03-1310	14	107	60	43	45	●
	5			1536SU05-1310	14	124	77	60	45	●
	3	Internal Intern	Zylinder- schaft	1534SU03C-1310	14	107	60	43	45	●
	5			1536SU05C-1310	14	124	77	60	45	●
	3	Internal Intern	Weldon shank/ Schaft	1634SU03C-1310	14	107	60	43	45	●
	5			1636SU05C-1310	14	124	77	60	45	●
	3		Whistle notch shank/ Schaft	1734SU03C-1310	14	107	60	43	45	●
	5			1736SU05C-1310	14	124	77	60	45	●
13.35	3	External Extern	Straight shank	1534SU03-1335	14	107	60	43	45	○
	5			1536SU05-1335	14	124	77	60	56	○
	3	Internal Intern	Zylinder- schaft	1534SU03C-1335	14	107	60	43	45	●
	5			1536SU05C-1335	14	124	77	60	56	○
	3	Internal Intern	Weldon shank/ Schaft	1634SU03C-1335	14	107	60	43	45	○
	5			1636SU05C-1335	14	124	77	60	56	○
	3		Whistle notch shank/ Schaft	1734SU03C-1335	14	107	60	43	45	○
	5			1736SU05C-1335	14	124	77	60	56	○



Solid carbide drills
Vollhartmetallbohrer

Material Overview · Material Übersicht

✓ = Very suitable · Sehr empfohlen
✓ = Suitable · Empfohlen

Type Typ	Grade Sorte	Workpiece material · Werkstückstoff										
		Carbon steel Kohlenstoff - Stahl HB≤180	Alloy steel Legierter Stahl	Hardened steel Gehärteter Stahl			Stainless steel Rostfreier Stahl	Cast iron, Grauguss	Nodular cast iron GGG Kugelgra- phitguss	Aluminum alloy Aluleg.	Copper alloy Kupferleg.	Heat resist. alloy Warmfeste Leg.
				~40HRC	~50HRC	~60HRC						
SU*	KDG303	✓	✓	✓			✓	✓	✓			
SUK*	KDG303							✓	✓			

All articles SUK on demand / Alle Artikel SUK auf Anfrage

Code key C 8
ISO Kennzeichen

Cutting data 96-109
Schnittdaten

Technical Information C110-116
Technische Information

Non-standard tailor made C 117-121
Bestellformular für Sonderwerkzeuge

Drilling · Bohren

Solid carbide drills · Vollhartmetallbohrer

SU&SUK

Please add K when ordering / Bitte bei der Bestellung K ergänzen

General machining · Allgemeine Bearbeitung

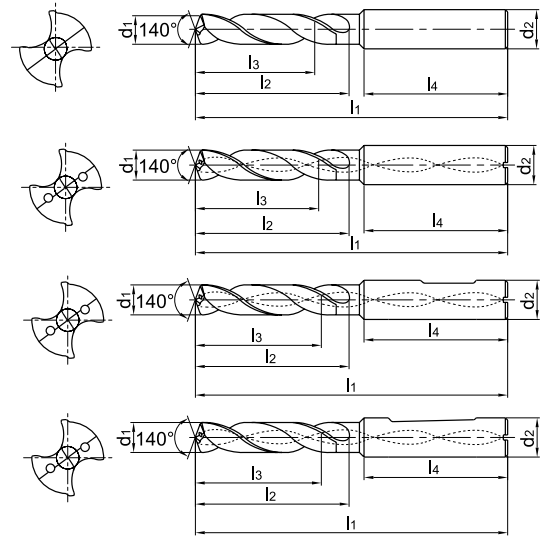
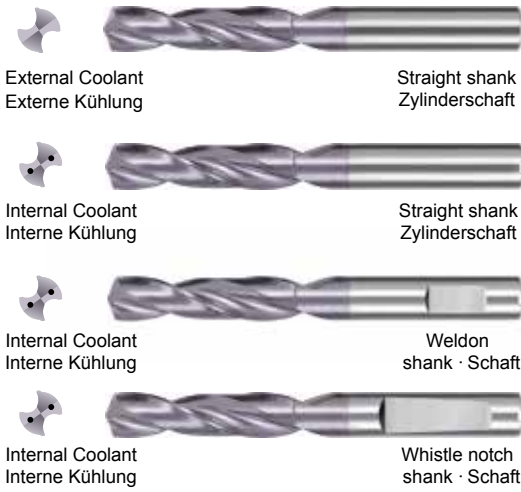

- For high efficient drilling of P (steel), M (stainless steel) and K (cast iron) with high performance.
- Waveform cutting edges achieve outstanding sharpness and strength, promoting chip removal.
- Hocheffizientes Bohren von allgemeinen Stahlwerkstoffen, rostfreien Werkstoffen und Guss.
- Wellenförmige Schneidkante mit hoher Schneidenschärfe, Stabilität und guter Spanabfuhr.

Drill diameter Bohrer Ø d1 (m7)	Drilling depth Bohrtiefe (L/d1)	Cooling mode Kühlmittel.	Shank Schaft	Type Typ	Basic dimension(mm) · Basis Abmessungen					Grade Sorte KDG303
					Shank diameter Ø Schaftdurchmesser	Overall length Gesamtlänge	Flute length Nutenlänge	effective drill. length Effektive Nutzlänge	Shank length Schaftlänge	
					d2 (h6)	l1	l2	l3	l4	
13.5	3	External Extern	Straight shank	1534SU03-1350	14	107	60	43	45	●
	5			1536SU05-1350	14	124	77	60	45	●
	3	Internal Intern	Zylinder- schaft	1534SU03C-1350	14	107	60	43	45	●
	5			1536SU05C-1350	14	124	77	60	45	●
	3		Weldon shank/ Schaft	1634SU03C-1350	14	107	60	43	45	●
	5			1636SU05C-1350	14	124	77	60	45	●
	3		Whistle notch shank/ Schaft	1734SU03C-1350	14	107	60	43	45	●
	5			1736SU05C-1350	14	124	77	60	45	●
8			1538SU08C-1350	14	178	133	116	45	●	
13.8	3	External Extern	Straight shank	1534SU03-1380	14	107	60	43	45	●
	5			1536SU05-1380	14	124	77	60	45	●
	3	Internal Intern	Zylinder- schaft	1534SU03C-1380	14	107	60	43	45	●
	5			1536SU05C-1380	14	124	77	60	45	●
	3		Weldon shank/ Schaft	1634SU03C-1380	14	107	60	43	45	●
	5			1636SU05C-1380	14	124	77	60	45	●
	3		Whistle notch shank/ Schaft	1734SU03C-1380	14	107	60	43	45	●
	5			1736SU05C-1380	14	124	77	60	45	●

Solid carbide drills
Vollhartmetallbohrer

Drilling - Bohren

Solid carbide drills - Vollhartmetallbohrer

Drill diameter Bohrer Ø d ₁ (m7)	Drilling depth Bohrtiefe (L/d1)	Cooling mode Kühlmittel.	Shank Schaft	Type Typ	Basic dimension(mm) · Basis Abmessungen					Grade Sorte
					Shank diameter Ø Schaftdurchmesser	Overall length Gesamtlänge	Flute length Nutenlänge	effective drill. length Effektive Nutzlänge	Shank length Schaftlänge	
					d ₂ (h6)	l ₁	l ₂	l ₃	l ₄	KDG303
14.0	3	External Extern	Straight shank	1534SU03-1400	14	107	60	43	45	●
	5			1536SU05-1400	14	124	77	60	45	●
	3	Internal Intern	Zylinder- schaft	1534SU03C-1400	14	107	60	43	45	●
	5			1536SU05C-1400	14	124	77	60	45	●
	3	Internal Intern	Weldon shank/ Schaft	1634SU03C-1400	14	107	60	43	45	●
	5			1636SU05C-1400	14	124	77	60	45	●
	3		Whistle notch shank/ Schaft	1734SU03C-1400	14	107	60	43	45	●
	5			1736SU05C-1400	14	124	77	60	45	●
8			1538SU08C-1400	14	178	133	116	45	●	
14.2	3	External Extern	Straight shank	1534SU03-1420	14	107	60	43	45	●
	5			1536SU05-1420	14	124	77	60	45	●
	3	Internal Intern	Zylinder- schaft	1534SU03C-1420	14	107	60	43	45	●
	5			1536SU05C-1420	14	124	77	60	45	●
	3	Internal Intern	Weldon shank/ Schaft	1634SU03C-1420	14	107	60	43	45	○
	5			1636SU05C-1420	14	124	77	60	45	●
	3		Whistle notch shank/ Schaft	1734SU03C-1420	14	107	60	43	45	●
	5			1736SU05C-1420	14	124	77	60	45	●
14.25	3	External Extern	Straight shank	1534SU03-1425	16	115	65	45	48	●
	5			1536SU05-1425	16	133	83	63	48	●
	3	Internal Intern	Zylinder- schaft	1534SU03C-1425	16	115	65	45	48	●
	5			1536SU05C-1425	16	133	83	63	48	●
	3	Internal Intern	Weldon shank/ Schaft	1634SU03C-1425	16	115	65	45	48	○
	5			1636SU05C-1425	16	133	83	63	48	●
	3		Whistle notch shank/ Schaft	1734SU03C-1425	16	115	65	45	48	●
	5			1736SU05C-1425	16	133	83	63	48	●
14.3	3	External Extern	Straight shank	1534SU03-1430	16	115	65	45	48	●
	5			1536SU05-1430	16	133	83	63	48	●
	3	Internal Intern	Zylinder- schaft	1534SU03C-1430	16	115	65	45	48	●
	5			1536SU05C-1430	16	133	83	63	48	●
	3	Internal Intern	Weldon shank/ Schaft	1634SU03C-1430	16	115	65	45	48	○
	5			1636SU05C-1430	16	133	83	63	48	●
	3		Whistle notch shank/ Schaft	1734SU03C-1430	16	115	65	45	48	●
	5			1736SU05C-1430	16	133	83	63	48	●



Solid carbide drills
Vollhartmetallbohrer

Material Overview · Material Übersicht

✓ = Very suitable · Sehr empfohlen
✓ = Suitable · Empfohlen

Type Typ	Grade Sorte	Workpiece material · Werkstückstoff										
		Carbon steel Kohlenstoff - Stahl HB≤180	Alloy steel Legierter Stahl	Hardened steel Gehärteter Stahl			Stainless steel Rostfreier Stahl	Cast iron, Grauguss	Nodular cast iron GGG Kugelgra- phitguss	Aluminum alloy Aluleg.	Copper alloy Kupferleg.	Heat resist. alloy Warmfeste Leg.
				~40HRC	~50HRC	~60HRC						
SU*	KDG303	✓	✓	✓			✓	✓	✓			
SUK*	KDG303							✓	✓			

All articles SUK on demand / Alle Artikel SUK auf Anfrage

Code key C 8
ISO Kennzeichen

Cutting data 96-109
Schnittdaten

Technical Information C110-116
Technische Information

Non-standard tailor made C 117-121
Bestellformular für Sonderwerkzeuge

Drilling · Bohren

Solid carbide drills · Vollhartmetallbohrer

SU&SUK

Please add K when ordering / Bitte bei der Bestellung K ergänzen

General machining · Allgemeine Bearbeitung

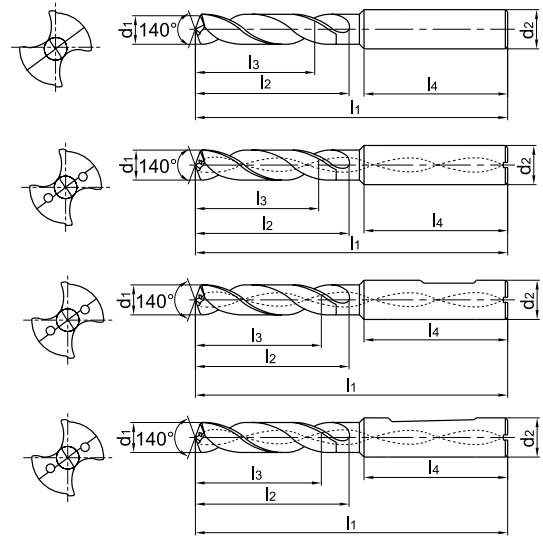
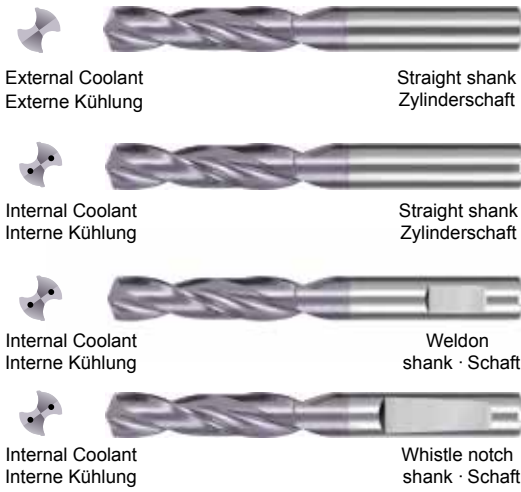

- For high efficient drilling of P (steel), M (stainless steel) and K (cast iron) with high performance.
- Waveform cutting edges achieve outstanding sharpness and strength, promoting chip removal.
- Hocheffizientes Bohren von allgemeinen Stahlwerkstoffen, rostfreien Werkstoffen und Guss.
- Wellenförmige Schneidkante mit hoher Schneidenschärfe, Stabilität und guter Spanabfuhr.

Drill diameter Bohrer Ø d ₁ (m7)	Drilling depth Bohrtiefe (L/d1)	Cooling mode Kühlmittel.	Shank Schaft	Type Typ	Basic dimension(mm) · Basis Abmessungen					Grade Sorte
					Shank diameter Ø Schaftdurchmesser	Overall length Gesamtlänge	Flute length Nutenlänge	effective drill. length Effektive Nutzlänge	Shank length Schaftlänge	
					d ₂ (h6)	l ₁	l ₂	l ₃	l ₄	
14.5	3	External Extern	Straight shank Zylinder- schaft	1534SU03-1450	16	115	65	45	48	●
	5			1536SU05-1450	16	133	83	63	48	●
	3	Internal Intern	Weldon shank/Schaft	1534SU03C-1450	16	115	65	45	48	●
	5			1536SU05C-1450	16	133	83	63	48	●
	3		Whistle notch shank/Schaft	1634SU03C-1450	16	115	65	45	48	●
	5			1636SU05C-1450	16	133	83	63	48	●
	3			1734SU03C-1450	16	115	65	45	48	●
	5			1736SU05C-1450	16	133	83	63	48	●
8			1538SU08C-1450	16	204	152	132	48	●	
14.75	3	External Extern	Straight shank Zylinder- schaft	1534SU03-1475	16	115	65	45	48	●
	5			1536SU05-1475	16	133	83	63	48	●
	3	Internal Intern	Weldon shank/Schaft	1534SU03C-1475	16	115	65	45	48	●
	5			1536SU05C-1475	16	133	83	63	48	●
	3		Whistle notch shank/Schaft	1634SU03C-1475	16	115	65	45	48	○
	5			1636SU05C-1475	16	133	83	63	48	○
	3			1734SU03C-1475	16	115	65	45	48	●
	5			1736SU05C-1475	16	133	83	63	48	●

Solid carbide drills
Vollhartmetallbohrer

Drilling - Bohren

Solid carbide drills - Vollhartmetallbohrer

Drill diameter Bohrer Ø d ₁ (m7)	Drilling depth Bohrtiefe (L/d1)	Cooling mode Kühlmittel.	Shank Schaft	Type Typ	Basic dimension(mm) · Basis Abmessungen					Grade Sorte
					Shank diameter Ø Schaftdurchmesser	Overall length Gesamtlänge	Flute length Nutenlänge	effective drill. length Effektive Nutzlänge	Shank length Schaftlänge	
					d ₂ (h6)	l ₁	l ₂	l ₃	l ₄	KDG303
14.8	3	External Extern	Straight shank	1534SU03-1480	16	115	65	45	48	●
	5			1536SU05-1480	16	133	83	63	48	●
	3	Internal Intern	Zylinder- schaft	1534SU03C-1480	16	115	65	45	48	●
	5			1536SU05C-1480	16	133	83	63	48	●
	3	Internal Intern	Weldon shank/Schaft	1634SU03C-1480	16	115	65	45	48	●
	5			1636SU05C-1480	16	133	83	63	48	●
	3	Internal Intern	Whistle notch shank/Schaft	1734SU03C-1480	16	115	65	45	48	●
	5			1736SU05C-1480	16	133	83	63	48	●
8	External Extern	Straight shank	1538SU08C-1480	16	204	152	132	48	●	
3			External Extern	Zylinder- schaft	1534SU03-1500	16	115	65	45	48
5	Internal Intern	Weldon shank/Schaft			1536SU05-1500	16	133	83	63	48
3			Internal Intern	Whistle notch shank/Schaft	1534SU03C-1500	16	115	65	45	48
5	Internal Intern	Weldon shank/Schaft			1536SU05C-1500	16	133	83	63	48
3			Internal Intern	Whistle notch shank/Schaft	1634SU03C-1500	16	115	65	45	48
5	Internal Intern	Whistle notch shank/Schaft			1636SU05C-1500	16	133	83	63	48
8			External Extern	Straight shank	1538SU08C-1500	16	204	152	132	48
3	External Extern	Zylinder- schaft			1534SU03-1510	16	115	65	45	48
5			Internal Intern	Weldon shank/Schaft	1536SU05-1510	16	133	83	63	48
3	Internal Intern	Whistle notch shank/Schaft			1534SU03C-1510	16	115	65	45	48
5			Internal Intern	Whistle notch shank/Schaft	1536SU05C-1510	16	133	83	63	48
3	External Extern	Zylinder- schaft			1634SU03C-1510	16	115	65	45	48
5			External Extern	Zylinder- schaft	1636SU05C-1510	16	133	83	63	48
3	Internal Intern	Weldon shank/Schaft			1734SU03C-1510	16	115	65	45	48
5			Internal Intern	Whistle notch shank/Schaft	1736SU05C-1510	16	133	83	63	48
3	External Extern	Zylinder- schaft			1534SU03-1530	16	115	65	45	48
5			Internal Intern	Weldon shank/Schaft	1536SU05C-1530	16	133	83	63	48
3	External Extern	Zylinder- schaft			1534SU03-1535	16	115	65	45	48
5			External Extern	Zylinder- schaft	1536SU05-1535	16	133	83	63	48
3	Internal Intern	Weldon shank/Schaft			1534SU03C-1535	16	115	65	45	48
5			Internal Intern	Whistle notch shank/Schaft	1536SU05C-1535	16	133	83	63	48
3	Internal Intern	Weldon shank/Schaft			1634SU03C-1535	16	115	65	45	48
5			Internal Intern	Whistle notch shank/Schaft	1636SU05C-1535	16	133	83	63	48
3	Internal Intern	Whistle notch shank/Schaft			1734SU03C-1535	16	115	65	45	48
5			Internal Intern	Whistle notch shank/Schaft	1736SU05C-1535	16	133	83	63	48



Solid carbide drills
Vollhartmetallbohrer

Material Overview · Material Übersicht

✓ = Very suitable · Sehr empfohlen
✓ = Suitable · Empfohlen

Type Typ	Grade Sorte	Workpiece material · Werkstückstoff										
		Carbon steel Kohlenstoff - Stahl HB≤180	Alloy steel Legierter Stahl	Hardened steel Gehärteter Stahl			Stainless steel Rostfreier Stahl	Cast iron, Grauguss	Nodular cast iron GGG Kugelgra- phitguss	Aluminum alloy Aluleg.	Copper alloy Kupferleg.	Heat resist. alloy Wärmfeste Leg.
				~40HRC	~50HRC	~60HRC						
SU*	KDG303	✓	✓	✓			✓	✓	✓			
SUK*	KDG303							✓	✓			

All articles SUK on demand / Alle Artikel SUK auf Anfrage

Code key C 8
ISO Kennzeichen

Cutting data 96-109
Schnittdaten

Technical Information C110-116
Technische Information

Non-standard tailor made C 117-121
Bestellformular für Sonderwerkzeuge

Drilling · Bohren

Solid carbide drills · Vollhartmetallbohrer

SU&SUK

Please add K when ordering / Bitte bei der Bestellung K ergänzen

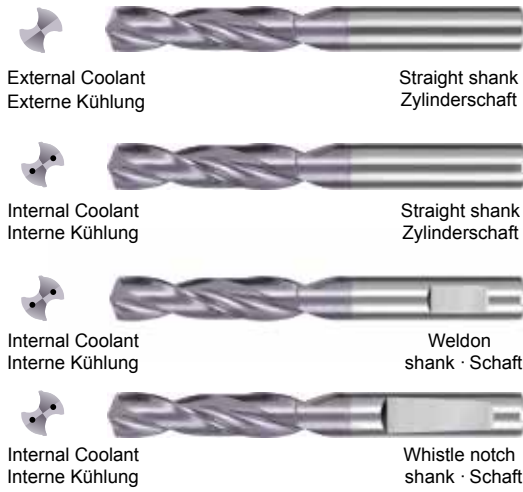

General machining · Allgemeine Bearbeitung

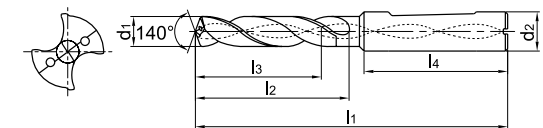
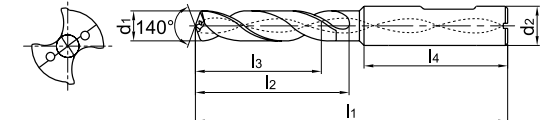
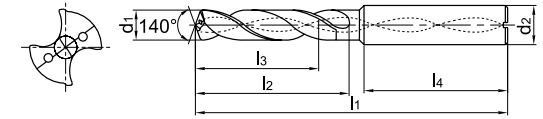
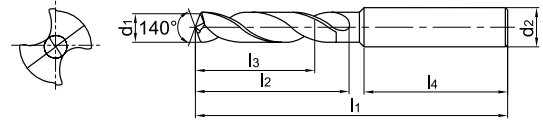

- For high efficient drilling of P (steel), M (stainless steel) and K (cast iron) with high performance.
- Waveform cutting edges achieve outstanding sharpness and strength, promoting chip removal.
- Hocheffizientes Bohren von allgemeinen Stahlwerkstoffen, rostfreien Werkstoffen und Guss.
- Wellenförmige Schneidkante mit hoher Schneidenschärfe, Stabilität und guter Spanabfuhr.

Drill diameter Bohrer Ø d1 (m7)	Drilling depth Bohrtiefe (L/d1)	Cooling mode Kühlmittel.	Shank Schaft	Type Typ	Basic dimension(mm) · Basis Abmessungen					Grade Sorte
					Shank diameter Ø Schaftdurchmesser	Overall length Gesamtlänge	Flute length Nutenlänge	effective drill. length Effektive Nutzlänge	Shank length Schaftlänge	
					d2(h6)	l1	l2	l3	l4	
15.5	3	External Extern	Straight shank	1534SU03-1550	16	115	65	45	48	●
	5			1536SU05-1550	16	133	83	63	48	●
	3	Internal Intern	Zylinder- schaft	1534SU03C-1550	16	115	65	45	48	●
	5			1536SU05C-1550	16	133	83	63	48	●
	3		Weldon shank/Schaft	1634SU03C-1550	16	115	65	45	48	○
	5			1636SU05C-1550	16	133	83	63	48	●
	3		Whistle notch shank/Schaft	1734SU03C-1550	16	115	65	45	48	●
	5			1736SU05C-1550	16	133	83	63	48	●
8		1538SU08C-1550	16	204	152	132	48	●		
15.8	3	External Extern	Straight shank	1534SU03-1580	16	115	65	45	48	●
	5			1536SU05-1580	16	133	83	63	48	●
	3	Internal Intern	Zylinder- schaft	1534SU03C-1580	16	115	65	45	48	●
	5			1536SU05C-1580	16	133	83	63	48	●
	3		Weldon shank/Schaft	1634SU03C-1580	16	115	65	45	48	○
	5			1636SU05C-1580	16	133	83	63	48	●
	3		Whistle notch shank/Schaft	1734SU03C-1580	16	115	65	45	48	●
	5			1736SU05C-1580	16	133	83	63	48	●
16.0	3	External Extern	Straight shank	1534SU03-1600	16	115	65	45	48	●
	5			1536SU05-1600	16	133	83	63	48	●
	3	Internal Intern	Zylinder- schaft	1534SU03C-1600	16	115	65	45	48	●
	5			1536SU05C-1600	16	133	83	63	48	●
	3		Weldon shank/Schaft	1634SU03C-1600	16	115	65	45	48	●
	5			1636SU05C-1600	16	133	83	63	48	●
	3		Whistle notch shank/Schaft	1734SU03C-1600	16	115	65	45	48	●
	5			1736SU05C-1600	16	133	83	63	48	●
8		1538SU08C-1600	16	204	152	132	48	●		
16.1	3	External Extern	Zylinder- schaft	1534SU03-1610	18	123	73	51	48	●

Solid carbide drills
Vollhartmetallbohrer

Drilling - Bohren

Solid carbide drills - Vollhartmetallbohrer

Drill diameter Bohrer Ø d ₁ (mm)	Drilling depth Bohrtiefe (L/d ₁)	Cooling mode Kühlmittel.	Shank Schaft	Type Typ	Basic dimension(mm) · Basis Abmessungen					Grade Sorte
					Shank diameter Ø Schaftdurchmesser	Overall length Gesamtlänge	Flute length Nutenlänge	effective drill. length Effektive Nutzlänge	Shank length Schaftlänge	
					d ₂ (h ₆)	l ₁	l ₂	l ₃	l ₄	KDG303
16.5	3	External Extern	Straight shank	1534SU03-1650	18	123	73	51	48	●
	5			1536SU05-1650	18	143	93	71	48	●
	3	Zylinder- schaft		1534SU03C-1650	18	123	73	51	48	●
	5			1536SU05C-1650	18	143	93	71	48	●
	3	Internal Intern	Weldon shank/Schaft	1634SU03C-1650	18	123	73	51	48	○
	5			1636SU05C-1650	18	143	93	71	48	●
	3		Whistle notch shank/Schaft	1734SU03C-1650	18	123	73	51	48	●
	5			1736SU05C-1650	18	143	93	71	48	●
8			1538SU08C-1650	18	223	171	149	48	●	
16.75	3	External Extern	Straight shank	1534SU03-1675	18	123	73	51	48	●
	5			1536SU05-1675	18	143	93	71	48	●
	3	Zylinder- schaft		1534SU03C-1675	18	123	73	51	48	●
	5			1536SU05C-1675	18	143	93	71	48	●
	3	Internal Intern	Weldon shank/Schaft	1634SU03C-1675	18	123	73	51	48	○
	5			1636SU05C-1675	18	143	93	71	48	○
	3		Whistle notch shank/Schaft	1734SU03C-1675	18	123	73	51	48	●
	5			1736SU05C-1675	18	143	93	71	48	●
16.8	3	External Extern	Straight shank	1534SU03-1680	18	123	73	51	48	●
	5			1536SU05-1680	18	143	93	71	48	●
	3	Zylinder- schaft		1534SU03C-1680	18	123	73	51	48	●
	5			1536SU05C-1680	18	143	93	71	48	●
	3	Internal Intern	Weldon shank/Schaft	1634SU03C-1680	18	123	73	51	48	○
	5			1636SU05C-1680	18	143	93	71	48	●
	3		Whistle notch shank/Schaft	1734SU03C-1680	18	123	73	51	48	●
	5			1736SU05C-1680	18	143	93	71	48	●
17.0	3	External Extern	Straight shank	1534SU03-1700	18	123	73	51	48	●
	5			1536SU05-1700	18	143	93	71	48	●
	3	Zylinder- schaft		1534SU03C-1700	18	123	73	51	48	●
	5			1536SU05C-1700	18	143	93	71	48	●
	3	Internal Intern	Weldon shank/Schaft	1634SU03C-1700	18	123	73	51	48	●
	5			1636SU05C-1700	18	143	93	71	48	●
	3		Whistle notch shank/Schaft	1734SU03C-1700	18	123	73	51	48	●
	5			1736SU05C-1700	18	143	93	71	48	●
8		straight shank Zylinderschaft	1538SU08C-1700	18	223	171	149	48	●	



Solid carbide drills
Vollhartmetallbohrer

Material Overview · Material Übersicht

✓ = Very suitable · Sehr empfohlen
✓ = Suitable · Empfohlen

Type Typ	Grade Sorte	Workpiece material · Werkstückstoff									
		Carbon steel Kohlenstoff - Stahl HB≤180	Alloy steel Legierter Stahl	Hardened steel Gehärteter Stahl			Stainless steel Rostfreier Stahl	Cast iron, Grauguss	Nodular cast iron GGG Kugelgra- phitguss	Aluminum alloy Aluleg.	Copper alloy Kupferleg.
				~40HRC	~50HRC	~60HRC					
SU*	KDG303	✓	✓	✓			✓	✓	✓		
SUK*	KDG303							✓	✓		

All articles SUK on demand / Alle Artikel SUK auf Anfrage

Code key C 8
ISO Kennzeichen

Cutting data 96-109
Schnittdaten

Technical Information C110-116
Technische Information

Non-standard tailor made C 117-121
Bestellformular für Sonderwerkzeuge

Drilling · Bohren

Solid carbide drills · Vollhartmetallbohrer

SU&SUK

Please add K when ordering / Bitte bei der Bestellung K ergänzen

General machining · Allgemeine Bearbeitung

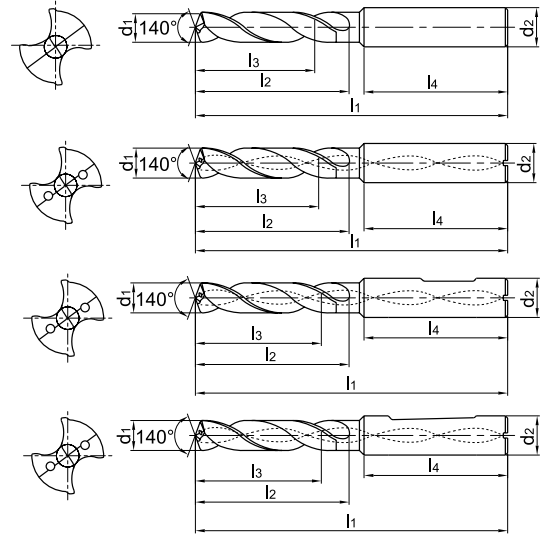
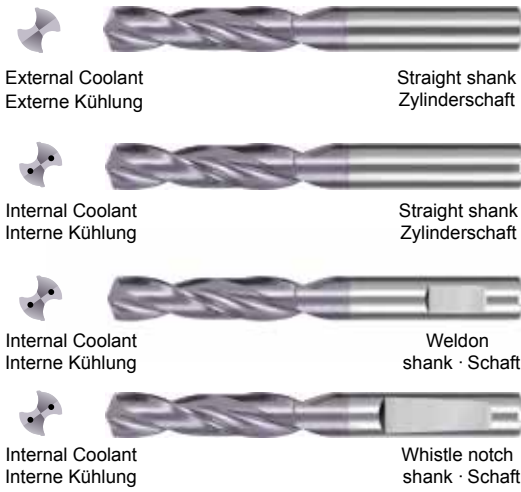

- For high efficient drilling of P (steel), M (stainless steel) and K (cast iron) with high performance.
- Waveform cutting edges achieve outstanding sharpness and strength, promoting chip removal.
- Hocheffizientes Bohren von allgemeinen Stahlwerkstoffen, rostfreien Werkstoffen und Guss.
- Wellenförmige Schneidkante mit hoher Schneidschärfe, Stabilität und guter Spanabfuhr.

Drill diameter Bohrer Ø d1 (m7)	Drilling depth Bohrtiefe (L/d1)	Cooling mode Kühlmittel.	Shank Schaft	Type Typ	Basic dimension(mm) · Basis Abmessungen					Grade Sorte
					Shank diameter Ø Schaftdurchmesser	Overall length Gesamtlänge	Flute length Nutenlänge	effective drill. length Effektive Nutzlänge	Shank length Schaftlänge	
					d2 (h6)	l1	l2	l3	l4	
17.5	3	External Extern	Straight shank Zylinderschaft	1534SU03-1750	18	123	73	51	48	●
	5			1536SU05-1750	18	143	93	71	48	●
	3	Internal Intern	Zylinder-schaft	1534SU03C-1750	18	123	73	51	48	●
	5			1536SU05C-1750	18	143	93	71	48	●
	3		Weld on shank/Schaft	1634SU03C-1750	18	123	73	51	48	○
	5			1636SU05C-1750	18	143	93	71	48	●
	3		Whistle notch shank/Schaft	1734SU03C-1750	18	123	73	51	48	●
	5			1736SU05C-1750	18	143	93	71	48	●
8	1538SU08C-1750	18	223	171	149	48	●			
17.8	3	External Extern	Straight shank Zylinder-schaft	1534SU03-1780	18	123	73	51	48	●
	5			1536SU05-1780	18	143	93	71	48	●
	3	Internal Intern	Zylinder-schaft	1534SU03C-1780	18	123	73	51	48	●
	5			1536SU05C-1780	18	143	93	71	48	●
	3		Weld on shank/Schaft	1634SU03C-1780	18	123	73	51	48	○
	5			1636SU05C-1780	18	143	93	71	48	●
	3		Whistle notch shank/Schaft	1734SU03C-1780	18	123	73	51	48	●
	5			1736SU05C-1780	18	143	93	71	48	●
8	1538SU08C-1780	18	223	171	149	48	●			
18.0	3	External Extern	Straight shank Zylinder-schaft	1534SU03-1800	18	123	73	51	48	●
	5			1536SU05-1800	18	143	93	71	48	●
	3	Internal Intern	Zylinder-schaft	1534SU03C-1800	18	123	73	51	48	●
	5			1536SU05C-1800	18	143	93	71	48	●
	3		Weld on shank/Schaft	1634SU03C-1800	18	123	73	51	48	●
	5			1636SU05C-1800	18	143	93	71	48	●
	3		Whistle notch shank/Schaft	1734SU03C-1800	18	123	73	51	48	●
	5			1736SU05C-1800	18	143	93	71	48	●
	8	straight shank Zylinderschaft	1538SU08C-1800	18	223	171	149	48	●	

Solid carbide drills
Vollhartmetallbohrer

Drilling - Bohren

Solid carbide drills - Vollhartmetallbohrer

Drill diameter Bohrer Ø d ₁ (m7)	Drilling depth Bohrtiefe (L/d1)	Cooling mode Kühlmittel.	Shank Schaft	Type Typ	Basic dimension(mm) · Basis Abmessungen					Grade Sorte
					Shank diameter Ø Schaftdurchmesser	Overall length Gesamtlänge	Flute length Nutenlänge	effective drill. length Effektive Nutzlänge	Shank length Schaftlänge	
					d ₂ (h6)	l ₁	l ₂	l ₃	l ₄	KDG303
18.5	3	External Extern	Straight shank	1534SU03-1850	20	131	79	55	50	●
	5			1536SU05-1850	20	153	101	77	50	●
	3		Zylinder- schaft	1534SU03C-1850	20	131	79	55	50	●
	5			1536SU05C-1850	20	153	101	77	50	●
	3	Internal Intern	Weldon shank/ Schaft	1634SU03C-1850	20	131	79	55	50	○
	5			1636SU05C-1850	20	153	101	77	50	●
	3		Whistle notch shank/ Schaft	1734SU03C-1850	20	131	79	55	50	●
5	1736SU05C-1850			20	153	101	77	50	●	
18.8	3	External Extern	Straight shank	1534SU03-1880	20	131	79	55	50	●
	5			1536SU05-1880	20	153	101	77	50	●
	3		Zylinder- schaft	1534SU03C-1880	20	131	79	55	50	●
	5			1536SU05C-1880	20	153	101	77	50	●
	3	Internal Intern	Weldon shank/ Schaft	1634SU03C-1880	20	131	79	55	50	○
	5			1636SU05C-1880	20	153	101	77	50	●
	3		Whistle notch shank/ Schaft	1734SU03C-1880	20	131	79	55	50	●
5	1736SU05C-1880			20	153	101	77	50	●	
19.0	3	External Extern	Straight shank	1534SU03-1900	20	131	79	55	50	●
	5			1536SU05-1900	20	153	101	77	50	●
	3		Zylinder- schaft	1534SU03C-1900	20	131	79	55	50	●
	5			1536SU05C-1900	20	153	101	77	50	●
	3	Internal Intern	Weldon shank/ Schaft	1634SU03C-1900	20	131	79	55	50	○
	5			1636SU05C-1900	20	153	101	77	50	●
	3		Whistle notch shank/ Schaft	1734SU03C-1900	20	131	79	55	50	●
5	1736SU05C-1900			20	153	101	77	50	●	
19.5	3	External Extern	Straight shank	1534SU03-1950	20	131	79	55	50	●
	5			1536SU05-1950	20	153	101	77	50	●
	3		Zylinder- schaft	1534SU03C-1950	20	131	79	55	50	●
	5			1536SU05C-1950	20	153	101	77	50	●
	3	Internal Intern	Weldon shank/ Schaft	1634SU03C-1950	20	131	79	55	50	○
	5			1636SU05C-1950	20	153	101	77	50	●
	3		Whistle notch shank/ Schaft	1734SU03C-1950	20	131	79	55	50	●
5	1736SU05C-1950			20	153	101	77	50	●	
19.8	3	External Extern	Straight shank	1534SU03-1980	20	131	79	55	50	●
	5			1536SU05-1980	20	153	101	77	50	●
	3		Zylinder- schaft	1534SU03C-1980	20	131	79	55	50	●
	5			1536SU05C-1980	20	153	101	77	50	●
	3	Internal Intern	Weldon shank/ Schaft	1634SU03C-1980	20	131	79	55	50	○
	5			1636SU05C-1980	20	153	101	77	50	●
	3		Whistle notch shank/ Schaft	1734SU03C-1980	20	131	79	55	50	●
5	1736SU05C-1980			20	153	101	77	50	●	



Solid carbide drills
Vollhartmetallbohrer

Material Overview · Material Übersicht

✓ = Very suitable · Sehr empfohlen
✓ = Suitable · Empfohlen

Type Typ	Grade Sorte	Workpiece material · Werkstückstoff										
		Carbon steel Kohlenstoff - Stahl HB≤180	Alloy steel Legierter Stahl	Hardened steel Gehärteter Stahl			Stainless steel Rostfreier Stahl	Cast iron, Grauguss	Nodular cast iron GGG Kugelgra- phitguss	Aluminum alloy Aluleg.	Copper alloy Kupferleg.	Heat resist. alloy Wärmfeste Leg.
				~40HRC	~50HRC	~60HRC						
SU*	KDG303	✓	✓	✓			✓	✓	✓			
SUK*	KDG303							✓	✓			

All articles SUK on demand / Alle Artikel SUK auf Anfrage

Code key C 8
ISO Kennzeichen

Cutting data 96-109
Schnittdaten

Technical Information C110-116
Technische Information

Non-standard tailor made C 117-121
Bestellformular für Sonderwerkzeuge

Drilling · Bohren

Solid carbide drills · Vollhartmetallbohrer

SU&SUK

Please add K when ordering / Bitte bei der Bestellung K ergänzen

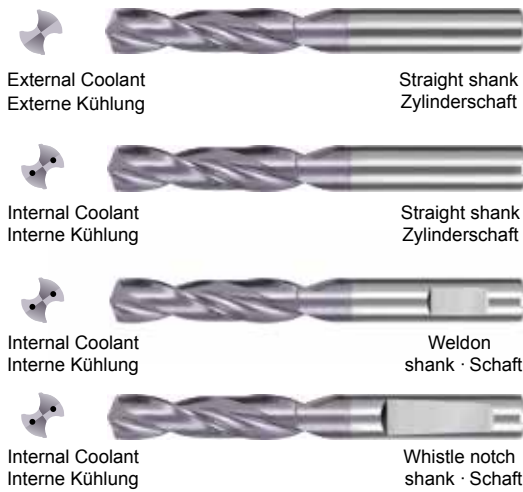

General machining · Allgemeine Bearbeitung

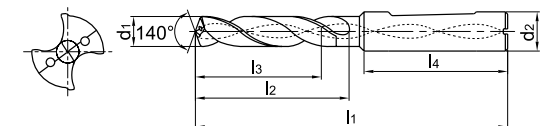
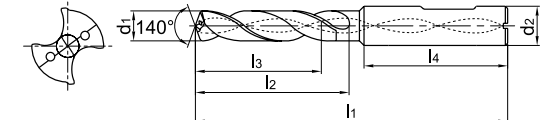
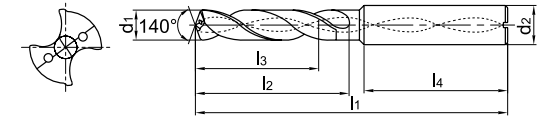
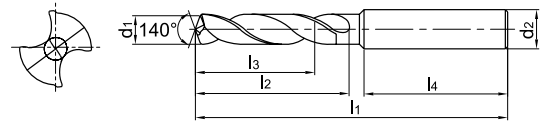

- For high efficient drilling of P (steel), M (stainless steel) and K (cast iron) with high performance.
- Waveform cutting edges achieve outstanding sharpness and strength, promoting chip removal.
- Hocheffizientes Bohren von allgemeinen Stahlwerkstoffen, rostfreien Werkstoffen und Guss.
- Wellenförmige Schneidkante mit hoher Schneidenschärfe, Stabilität und guter Spanabfuhr.

Drill diameter Bohrer Ø d ₁ (m7)	Drilling depth Bohrtiefe (L/d1)	Cooling mode Kühlmittel.	Shank Schaft	Type Typ	Basic dimension(mm) · Basis Abmessungen					Grade Sorte KDG303
					Shank diameter Ø Schaftdurchmesser	Overall length Gesamtlänge	Flute length Nutenlänge	effective drill. length Effektive Nutzlänge	Shank length Schaftlänge	
					d ₂ (h6)	l ₁	l ₂	l ₃	l ₄	
20.0	3	External Extern	Straight shank	1534SU03-2000	20	131	79	55	50	●
	5			1536SU05-2000	20	153	101	77	50	●
	3	Internal Intern	Zylinder- schaft	1534SU03C-2000	20	131	79	55	50	●
	5			1536SU05C-2000	20	153	101	77	50	●
	3	Internal Intern	Weldon shank/ Schaft	1634SU03C-2000	20	131	79	55	50	●
	5			1636SU05C-2000	20	153	101	77	50	●
	3	Internal Intern	Whistle notch shank/ Schaft	1734SU03C-2000	20	131	79	55	50	●
	5			1736SU05C-2000	20	153	101	77	50	●

C

Solid carbide drills
Vollhartmetallbohrer

SU & SUK

Please add K when ordering / Bitte bei der Bestellung K ergänzen

General machining · Allgemeine Bearbeitung
(Step drill · Stufenbohrer)



External Coolant
Externe Kühlung

Straight shank
Zylinderschaft

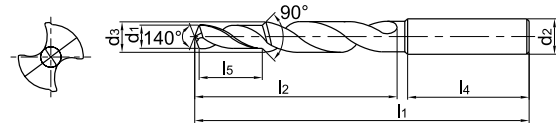

- For thread pre-hole, chamfering.
- Gewindebohrung mit Fase.

Drill diameter d ₁ (m8)	Drilling depth Bohrtiefe (L/d ₁)	Cooling mode Kühlmittel	Shank Schaft	Type Typ	Basic dimension(mm) · Basis Abmessungen						Grade Sorte	
					Thread size Gewinde	d ₂ (h ₆)	d ₃	l ₁	l ₂	l ₄		l ₅
3.3	3	External Extern	Straight shank Zylinderschaft	1557SU03-M4	M4	6.0	4.5	66	28	36	11.4	●
4.2	3			1557SU03-M5	M5	6.0	6.0	66	28	36	13.6	●
5.0	3			1557SU03-M6	M6	8.0	7.0	79	41	36	16.5	●
6.75	3			1557SU03-M8	M8	10.0	9.5	89	47	40	21.0	●
8.5	3			1557SU03-M10	M10	12.0	12.0	102	55	45	25.5	●
10.25	3			1557SU03-M12	M12	14.0	14.0	107	60	45	30.0	●
12.0	3			1557SU03-M14	M14	16.0	16.0	115	65	48	34.5	●
14.0	3			1557SU03-M16	M16	18.0	18.0	123	73	48	38.5	●
7.0	3			1557SU03-M8×1.0	M8×1.0	10.0	9.8	89	47	40	21.0	○
9.0	3			1557SU03-M10×1.0	M10×1.0	12.0	12.0	102	55	45	25.5	○
10.5	3			1557SU03-M12×1.5	M12×1.5	14.0	14.0	107	60	45	30.0	●
12.5	3			1557SU03-M14×1.5	M14×1.5	16.0	16.0	115	65	48	34.5	○
14.5	3			1557SU03-M16×1.5	M16×1.5	18.0	18.0	123	73	48	38.5	○

Attentions when using step drill · Einsatzempfehlung für Stufenbohrer

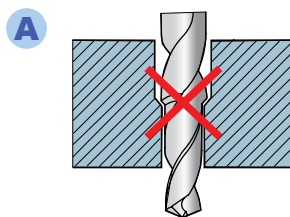

Because of no chamfer on the large diameter, countersink drill as shown above is not possible.

Aufgrund der fehlenden Fase bei großen Durchmessern ist das Aufbohren nicht zu empfehlen.

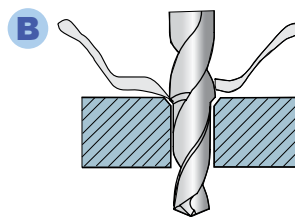

Long chips will roll around the drill and obstruct machining when countersink drill. It is recommended to select small feed drilling in order to cut chips.

Beim Ansenken können lange Späne entstehen. Vorschub reduzieren.

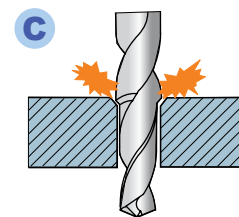

When countersink drill, cutting force increases at initial. Reduce the feedrate/ please.

Beim Aufbohren werden die Schnittkräfte höher. Bitte Vorschub reduzieren.

Material Overview · Material Übersicht

- ✓ = Very suitable · Sehr empfohlen
- ✓ = Suitable · Empfohlen

Type Typ	Grade Sorte	Workpiece material · Werkstückstoff									
		Carbon steel Kohlenstoff - Stahl HB≤180	Alloy steel Legierter Stahl	Hardened steel Gehärteter Stahl			Stainless steel Rostfreier Stahl	Cast iron, Grauguss	Nodular cast iron GGG Kugelgraphitguss	Aluminum alloy Aluleg.	Copper alloy Kupferleg.
		~40HRC	~50HRC	~60HRC							
SU*	KDG303	✓	✓	✓			✓	✓			
SUK*	KDG303								✓	✓	

All articles SUK on demand / Alle Artikel SUK auf Anfrage

G

Solid carbide drills
Vollhartmetallbohrer

1588SL for deep drilling zum Tiefbohren

10xD 12xD 15xD 20xD 30xD Drills/Bohrer

- Special flute design for optimal stability and good chip flow
Spezielles Spannutendesign für optimale Stabilität und guten Spanabfluß
- Special margin for high accuracy and stable operation
Spezielle Führungsfase für hohe Genauigkeit und eine stabile Bearbeitung
- Optimal cutting edge for good chip control in different materials
Optimierte Schneidkantenausführung für guten Spanbruch in vielen Anwendungsbereichen
- New PVD-coating for smooth chip flow, less friction and good wear resistance
Neuartige PVD-Beschichtung für optimalen Spanabfluß, weniger Reibung und gute Verschleißfestigkeit

1588SLK **NEW** DIN 1412 D

Deep drills for grey cast iron

Tieflochbohrer für die Bearbeitung von Graugussmaterialien

For grey cast iron
Für Graugussmaterialien

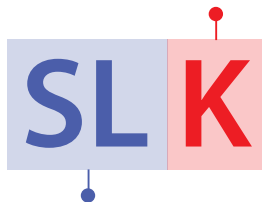

Twist drill for deep drilling
Spiralbohrer zum Tieflochbohren

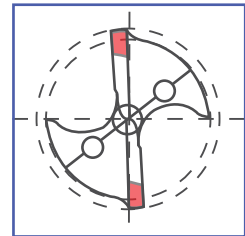
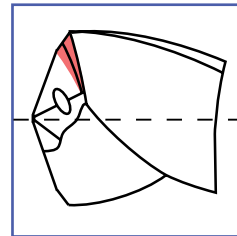

Form D - Double Angle for Cast Iron
Form D - Anschlag für Grauguss

- **Applications / Anwendung:**
For drilling grey cast iron, malleable cast iron and forgings.
Für Bohrungen in Grauguss, Temperguss und Schmiedestücke.
- **Advantages / Vorteile:**
Wear on cutting corners is reduced by extended major cutting edges, resistant to impact, good heat conductivity, all giving improved tool life.
Schonung der Schneidenecken durch verlängerte Hauptschneiden, unempfindlich gegen Stoß, gute Wärmeableitung – dadurch verbesserte Standzeit.

All articles 1588SLK on demand, please add **K** when ordering.

Alle Artikel 1588SLK auf Anfrage, bitte bei der Bestellung **K** ergänzen.

1588SLK10C-0300

1588SL Serie Vergleich der Schnittkraft

Type / Typ	1588SL12C	Competitor Wettbewerb	Feed Vorschub	0.2mm/r
Diameter Durchmesser	Ø6mm	Ø6mm	Cutting Depth Bohrtiefe	72mm
Material	42CrMo(HB250)		cooling Kühlung	Emulsion
Cutting speed Schnittgesch.	80m/min		Machine Maschine	CNC

1588SL

other manufacturer / Andere Hersteller

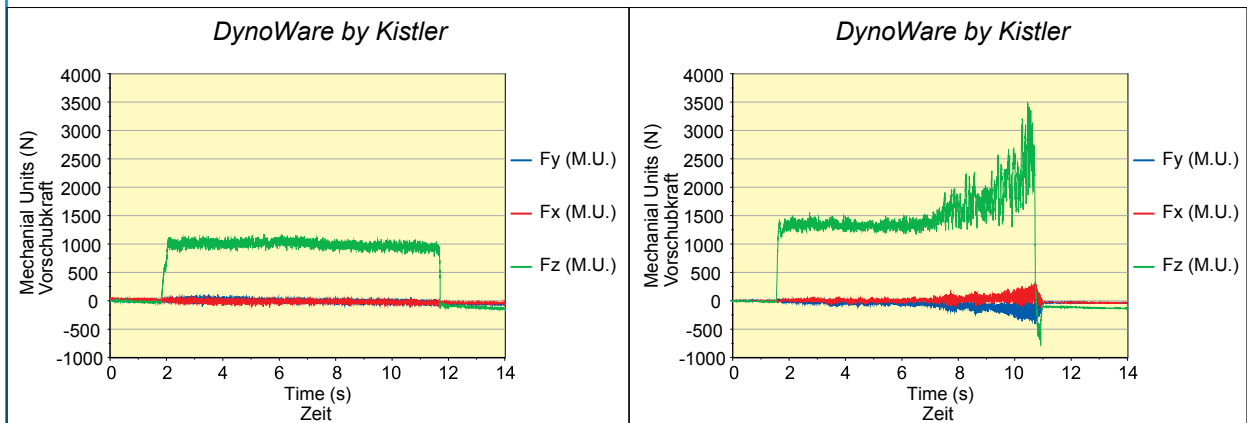

1588SL Serie Spanbruchverhalten

Type / Typ: 1588SL12C
 Diameter / Durchmesser : Ø10mm
 Material / Material: 45Stahl (HB200)
 Vc: 80-120(m/min)
 f_n: 0.2-0.4(mm/r)
 Drilling depth / Bohrtiefe : 120mm
 Cooling / Kühlsystem: Emulsion
 Machine / Maschine: CNC Machine

Stable machining under different cutting speed and feed rate.

Stabile Bearbeitung bei verschiedenen Geschwindigkeiten und Vorschüben.

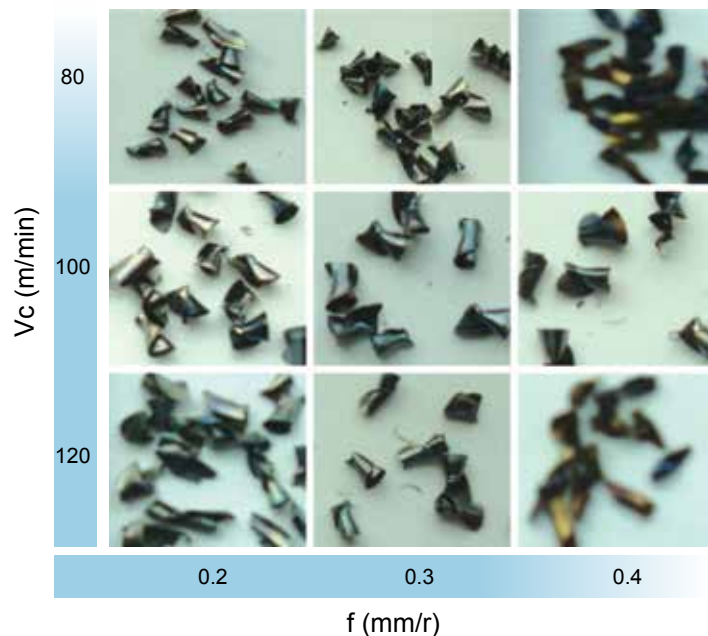

Drilling · Bohren

Solid carbide drills · Vollhartmetallbohrer

SL & SLK

Please add K when ordering / Bitte bei der Bestellung K ergänzen

General machining · Allgemeine Bearbeitung
(Deep drill · Tieflochbohrer)

1588SL10C / 1588SL12C / 1588SL15C



1588SL20C / 1588SL30C

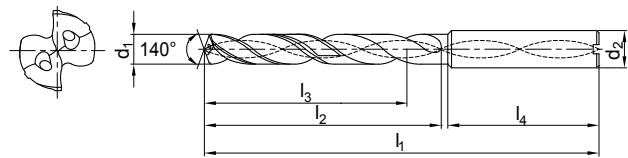
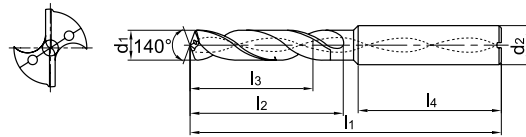

Drilling diameter Bohrerdurchmesser d1 12/15D(m7) 20/30D(h7)	Drilling depth Bohrtiefe l/d1	Cooling mode Kühlmittel.	Shank Schaft	Type Typ	Basic dimension(mm) · Basis Abmessungen					Grade Sorte
					d2(h5)	l1	l2	l3	l4	
										KDG303
3.0	10	Internal Intern	Straight shank Zylinder- schaft	1588SL10C-0300	6	80	43	39	36	●
	12			1588SL12C-0300	6	90	50	40	36	●
	15			1588SL15C-0300	6	100	60	50	36	●
	20			1588SL20C-0300	6	110	70	62	36	●
	30			1588SL30C-0300	6	140	100	92	36	●
3.1	10			1588SL10C-0310	6	80	43	39	36	○
	12			1588SL12C-0310	6	90	50	40	36	●
	15			1588SL15C-0310	6	105	65	55	36	○
	20			1588SL20C-0310	6	123	83	72	36	●
	30			1588SL30C-0310	6	160	120	108	36	●
3.2	10			1588SL10C-0320	6	80	43	39	36	●
	12			1588SL12C-0320	6	90	50	40	36	●
	15			1588SL15C-0320	6	105	65	55	36	○
	20			1588SL20C-0320	6	123	83	72	36	●
	30			1588SL30C-0320	6	160	120	108	36	●
3.3	10	1588SL10C-0330	6	80	43	39	36	●		
	12	1588SL12C-0330	6	90	50	40	36	●		
	15	1588SL15C-0330	6	105	65	55	36	●		
	20	1588SL20C-0330	6	123	83	72	36	●		
	30	1588SL30C-0330	6	160	120	108	36	○		
3.4	10	1588SL10C-0340	6	80	43	39	36	●		
	12	1588SL12C-0340	6	90	50	40	36	●		
	15	1588SL15C-0340	6	105	65	55	36	●		
	20	1588SL20C-0340	6	123	83	72	36	●		
	30	1588SL30C-0340	6	160	120	108	36	●		
3.5	10	1588SL10C-0350	6	80	43	39	36	●		
	12	1588SL12C-0350	6	90	50	40	36	●		
	15	1588SL15C-0350	6	105	65	55	36	●		
	20	1588SL20C-0350	6	123	83	72	36	●		
	30	1588SL30C-0350	6	160	120	108	36	●		
3.6	10	1588SL10C-0360	6	80	43	39	36	●		
	12	1588SL12C-0360	6	90	50	40	36	●		
	15	1588SL15C-0360	6	112	72	62	36	○		
	20	1588SL20C-0360	6	136	96	84	36	●		
	30	1588SL30C-0360	6	176	136	124	36	○		
3.7	10	1588SL10C-0370	6	80	43	39	36	●		
	12	1588SL12C-0370	6	90	50	46	36	●		
	15	1588SL15C-0370	6	112	72	68	36	●		
	20	1588SL20C-0370	6	136	96	84	36	●		
	30	1588SL30C-0370	6	176	136	124	36	○		
3.8	10	1588SL10C-0380	6	80	43	39	36	●		
	12	1588SL12C-0380	6	90	50	46	36	●		
	15	1588SL15C-0380	6	112	72	68	36	●		
	20	1588SL20C-0380	6	136	96	84	36	●		
	30	1588SL30C-0380	6	176	136	124	36	○		
3.9	10	1588SL10C-0390	6	80	43	39	36	●		
	12	1588SL12C-0390	6	90	50	46	36	●		
	15	1588SL15C-0390	6	112	72	68	36	●		
	20	1588SL20C-0390	6	136	96	84	36	●		
	30	1588SL30C-0390	6	176	136	124	36	○		



Solid carbide drills
Vollhartmetallbohrer

Drilling - Bohren

Solid carbide drills · Vollhartmetallbohrer

Drilling diameter Bohrerdurchmesser d1 12/15D(m7) 20/30D(h7)	Drilling depth Bohrtiefe l(l/d1)	Cooling mode Kühlmittel.	Shank Schaft	Type Typ	Basic dimension(mm) · Basis Abmessungen					Grade Sorte				
					d2(h5)	l1	l2	l3	l4					
										KDG303				
4.0	10	Internal Intern	Straight shank Zylinder- schaft	1588SL10C-0400	6	92	55	50	36	●				
	12			1588SL12C-0400	6	102	64	56	36	●				
	15			1588SL15C-0400	6	112	72	64	36	●				
	20			1588SL20C-0400	6	136	96	84	36	●				
30	1588SL30C-0400			6	176	136	124	36	●					
4.1	10			Internal Intern	Straight shank Zylinder- schaft	1588SL10C-0410	6	92	55	50	36	●		
	12					1588SL12C-0410	6	102	64	56	36	●		
	15					1588SL15C-0410	6	120	80	72	36	●		
	20					1588SL20C-0410	6	148	108	96	36	●		
30	1588SL30C-0410					6	192	152	140	36	○			
4.2	10					Internal Intern	Straight shank Zylinder- schaft	1588SL10C-0420	6	92	55	50	36	●
	12							1588SL12C-0420	6	102	64	56	36	●
	15	1588SL15C-0420	6					120	80	72	36	●		
	20	1588SL20C-0420	6					148	108	96	36	●		
30	1588SL30C-0420	6	192					152	140	36	○			
4.3	10	Internal Intern	Straight shank Zylinder- schaft					1588SL10C-0430	6	92	55	50	36	●
	12							1588SL12C-0430	6	102	64	56	36	●
	15			1588SL15C-0430	6			120	80	72	36	○		
	20			1588SL20C-0430	6			148	108	96	36	●		
30	1588SL30C-0430			6	192			152	140	36	○			
4.4	10			Internal Intern	Straight shank Zylinder- schaft			1588SL10C-0440	6	92	55	50	36	●
	12							1588SL12C-0440	6	102	64	56	36	●
	15					1588SL15C-0440	6	120	80	72	36	○		
	20					1588SL20C-0440	6	148	108	96	36	●		
30	1588SL30C-0440					6	192	152	140	36	○			
4.5	10					Internal Intern	Straight shank Zylinder- schaft	1588SL10C-0450	6	92	55	50	36	●
	12							1588SL12C-0450	6	102	64	56	36	●
	15	1588SL15C-0450	6					120	80	72	36	●		
	20	1588SL20C-0450	6					148	108	96	36	●		
30	1588SL30C-0450	6	192					152	140	36	●			
4.6	10	Internal Intern	Straight shank Zylinder- schaft					1588SL10C-0460	6	92	55	50	36	●
	12							1588SL12C-0460	6	102	64	56	36	●
	15			1588SL15C-0460	6			128	88	80	36	●		
	20			1588SL20C-0460	6			158	118	106	36	●		
30	1588SL30C-0460			6	208			168	156	36	○			
4.7	10			Internal Intern	Straight shank Zylinder- schaft			1588SL10C-0470	6	92	55	50	36	●
	12							1588SL12C-0470	6	102	64	56	36	●
	15					1588SL15C-0470	6	128	88	80	36	○		
	20					1588SL20C-0470	6	158	118	106	36	●		
30	1588SL30C-0470					6	208	168	156	36	●			
4.8	10					Internal Intern	Straight shank Zylinder- schaft	1588SL10C-0480	6	92	55	50	36	●
	12							1588SL12C-0480	6	102	64	56	36	●
	15	1588SL15C-0480	6					128	88	80	36	●		
	20	1588SL20C-0480	6					158	118	106	36	●		
30	1588SL30C-0480	6	208					168	156	36	●			
4.9	10	Internal Intern	Straight shank Zylinder- schaft					1588SL10C-0490	6	92	55	50	36	●
	12							1588SL12C-0490	6	102	64	56	36	●
	15			1588SL15C-0490	6			128	88	80	36	●		
	20			1588SL20C-0490	6			158	118	106	36	○		
30	1588SL30C-0490			6	208			168	156	36	○			
5.0	10			Internal Intern	Straight shank Zylinder- schaft			1588SL10C-0500	6	104	68	61	36	●
	12							1588SL12C-0500	6	116	78	72	36	●
	15					1588SL15C-0500	6	128	88	82	36	●		
	20					1588SL20C-0500	6	158	118	106	36	●		
30	1588SL30C-0500					6	208	168	156	36	●			

Material Overview · Material Übersicht

✓ = Very suitable · Sehr empfohlen
 ✓ = Suitable · Empfohlen

Type Typ	Grade Sorte	Workpiece material · Werkstückstoff										
		Carbon steel Kohlenstoff- Stahl HB≤180	Alloy steel Legierter Stahl	Hardened steel · Gehärteter Stahl			Stainless steel Rostfreier Stahl	Grey cast iron Gusseisen	Nodular cast iron GGG Kugelgra- phitguss	Aluminum alloy Aluleg.	Copper alloy Kupferleg.	Heat resist. alloy Warmfeste Leg.
			~40HRC	~50HRC	~60HRC							
1588SL*	KDG303	✓	✓	✓			✓	✓	✓	✓		✓
1588SLK*	KDG303							✓				

All articles 1588SLK on demand / Alle Artikel 1588SLK auf Anfrage

Code key C 8
ISO Kennzeichen

Cutting data 96-109
Schnittdaten

Technical Information C110-116
Technische Information

Non-standard tailor made C 117-121
Bestellformular für Sonderwerkzeuge



Drilling · Bohren

Solid carbide drills · Vollhartmetallbohrer

SL & SLK

Please add K when ordering / Bitte bei der Bestellung K ergänzen

General machining · Allgemeine Bearbeitung
(Deep drill · Tieflochbohrer)

1588SL10C / 1588SL12C / 1588SL15C

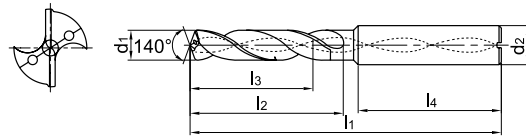

1588SL20C / 1588SL30C

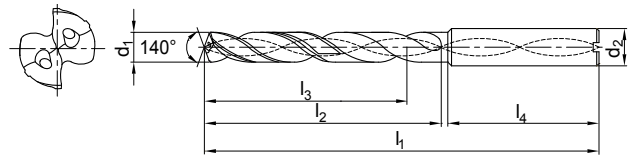

Drilling diameter Bohrerdurchmesser d1 12/15D(m7) 20/30D(h7)	Drilling depth Bohrtiefe (l/d1)	Cooling mode Kühlmittel.	Shank Schaft	Type Typ	Basic dimension(mm) · Basis Abmessungen					Grade Sorte
					d2(h5)	l1	l2	l3	l4	KDG303
5.1	10	Internal Intern	Straight shank Zylinder- schaft	1588SL10C-0510	6	104	68	61	36	●
	12			1588SL12C-0510	6	116	78	72	36	●
	15			1588SL15C-0510	6	136	96	90	36	●
	20			1588SL20C-0510	6	168	128	116	36	○
	30			1588SL30C-0510	6	228	188	170	36	○
5.2	10			1588SL10C-0520	6	104	68	61	36	●
	12			1588SL12C-0520	6	116	78	72	36	●
	15			1588SL15C-0520	6	136	96	90	36	○
	20			1588SL20C-0520	6	168	128	116	36	●
	30			1588SL30C-0520	6	228	188	170	36	●
5.3	10			1588SL10C-0530	6	104	68	61	36	●
	12			1588SL12C-0530	6	116	78	72	36	○
	15			1588SL15C-0530	6	136	96	90	36	●
	20			1588SL20C-0530	6	168	128	116	36	●
	30			1588SL30C-0530	6	228	188	170	36	●
5.4	10			1588SL10C-0540	6	104	68	61	36	●
	12			1588SL12C-0540	6	116	78	72	36	○
	15			1588SL15C-0540	6	136	96	90	36	○
	20			1588SL20C-0540	6	168	128	116	36	●
	30			1588SL30C-0540	6	228	188	170	36	○
5.5	10			1588SL10C-0550	6	104	68	61	36	●
	12			1588SL12C-0550	6	116	78	72	36	●
	15			1588SL15C-0550	6	136	96	90	36	●
	20			1588SL20C-0550	6	168	128	116	36	●
	30			1588SL30C-0550	6	228	188	170	36	●
5.6	10			1588SL10C-0560	6	104	68	61	36	●
	12			1588SL12C-0560	6	116	78	72	36	●
	15			1588SL15C-0560	6	144	104	98	36	○
	20			1588SL20C-0560	6	180	140	126	36	○
	30			1588SL30C-0560	6	240	200	182	36	○
5.7	10	1588SL10C-0570	6	104	68	61	36	●		
	12	1588SL12C-0570	6	116	78	72	36	●		
	15	1588SL15C-0570	6	144	104	98	36	○		
	20	1588SL20C-0570	6	180	140	126	36	○		
	30	1588SL30C-0570	6	240	200	182	36	○		
5.8	10	1588SL10C-0580	6	104	68	61	36	●		
	12	1588SL12C-0580	6	116	78	72	36	●		
	15	1588SL15C-0580	6	144	104	98	36	○		
	20	1588SL20C-0580	6	180	140	126	36	●		
	30	1588SL30C-0580	6	240	200	182	36	●		
5.9	10	1588SL10C-0590	6	104	68	61	36	●		
	12	1588SL12C-0590	6	116	78	72	36	●		
	15	1588SL15C-0590	6	144	104	98	36	○		
	20	1588SL20C-0590	6	180	140	126	36	○		
	30	1588SL30C-0590	6	240	200	182	36	○		
6.0	10	1588SL10C-0600	6	104	68	61	36	●		
	12	1588SL12C-0600	6	116	78	72	36	●		
	15	1588SL15C-0600	6	144	104	98	36	●		
	20	1588SL20C-0600	6	180	140	126	36	●		
	30	1588SL30C-0600	6	240	200	182	36	●		

Drilling - Bohren

Solid carbide drills - Vollhartmetallbohrer

Drilling diameter Bohrerdurchmesser d1 12/15D(m7) 20/30D(h7)	Drilling depth Bohrtiefe l(d1)	Cooling mode Kühlmittel.	Shank Schaft	Type Typ	Basic dimension(mm) · Basis Abmessungen					Grade Sorte
					dz(h5)	l1	l2	l3	l4	
										KDG303
6.1	10	Internal Intern	Straight shank Zylinder- schaft	1588SL10C-0610	8	117	80	71	36	●
	12			1588SL12C-0610	8	131	93	84	36	●
	15			1588SL15C-0610	8	152	112	103	36	○
	20			1588SL20C-0610	8	192	150	132	36	●
30	1588SL30C-0610			8	260	220	202	36	○	
6.2	10			1588SL10C-0620	8	117	80	71	36	●
	12			1588SL12C-0620	8	131	93	84	36	●
	15			1588SL15C-0620	8	152	112	103	36	●
	20			1588SL20C-0620	8	192	150	132	36	○
30	1588SL30C-0620			8	260	220	202	36	○	
6.3	10			1588SL10C-0630	8	117	80	71	36	●
	12			1588SL12C-0630	8	131	93	84	36	●
	15			1588SL15C-0630	8	152	112	103	36	○
	20			1588SL20C-0630	8	192	150	132	36	○
30	1588SL30C-0630			8	260	220	202	36	●	
6.4	10			1588SL10C-0640	8	117	80	71	36	●
	12			1588SL12C-0640	8	131	93	84	36	●
	15			1588SL15C-0640	8	152	112	103	36	●
	20			1588SL20C-0640	8	192	150	132	36	○
30	1588SL30C-0640			8	260	220	202	36	○	
6.5	10			1588SL10C-0650	8	117	80	71	36	●
	12			1588SL12C-0650	8	131	93	84	36	●
	15			1588SL15C-0650	8	152	112	103	36	●
	20			1588SL20C-0650	8	192	150	132	36	●
30	1588SL30C-0650			8	260	220	202	36	●	
6.6	10			1588SL10C-0660	8	117	80	71	36	●
	12			1588SL12C-0660	8	131	93	84	36	●
	15			1588SL15C-0660	8	160	120	111	36	○
	20	1588SL20C-0660	8	202	162	144	36	○		
30	1588SL30C-0660	8	272	232	214	36	○			
6.7	10	1588SL10C-0670	8	117	80	71	36	●		
	12	1588SL12C-0670	8	131	93	84	36	●		
	15	1588SL15C-0670	8	160	120	111	36	●		
	20	1588SL20C-0670	8	202	162	144	36	○		
30	1588SL30C-0670	8	272	232	214	36	○			
6.8	10	1588SL10C-0680	8	117	80	71	36	●		
	12	1588SL12C-0680	8	131	93	84	36	●		
	15	1588SL15C-0680	8	160	120	111	36	○		
	20	1588SL20C-0680	8	202	162	144	36	●		
30	1588SL30C-0680	8	272	232	214	36	●			
6.9	10	1588SL10C-0690	8	117	80	71	36	●		
	12	1588SL12C-0690	8	131	93	84	36	●		
	15	1588SL15C-0690	8	160	120	111	36	○		
	20	1588SL20C-0690	8	202	162	144	36	●		
30	1588SL30C-0690	8	272	232	214	36	○			
7.0	10	1588SL10C-0700	8	117	80	71	36	●		
	12	1588SL12C-0700	8	131	93	84	36	●		
	15	1588SL15C-0700	8	160	120	111	36	●		
	20	1588SL20C-0700	8	202	162	144	36	●		
30	1588SL30C-0700	8	272	232	214	36	●			
7.1	10	1588SL10C-0710	8	130	94	84	36	●		
	12	1588SL12C-0710	8	146	108	96	36	●		
	15	1588SL15C-0710	8	170	130	118	36	●		
	20	1588SL20C-0710	8	213	173	155	36	○		
30	1588SL30C-0710	8	290	250	232	36	○			

Material Overview · Material Übersicht

✓ = Very suitable · Sehr empfohlen
 ✓ = Suitable · Empfohlen

Type Typ	Grade Sorte	Workpiece material · Werkstückstoff									
		Carbon steel Kohlenstoff- Stahl HB≤180	Alloy steel Legierter Stahl	Hardened steel · Gehärteter Stahl			Stainless steel Rostfreier Stahl	Grey cast iron Gusseisen	Nodular cast iron GGG Kugelgra- phitguss	Aluminum alloy Aluleg.	Copper alloy Kupferleg.
			~40HRC	~50HRC	~60HRC						
1588SL*	KDG303	✓	✓	✓			✓	✓	✓	✓	✓
1588SLK*	KDG303							✓			

All articles 1588SLK on demand / Alle Artikel 1588SLK auf Anfrage

Code key **C 8**
ISO Kennzeichen

Cutting data **96-109**
Schnittdaten

Technical Information **C110-116**
Technische Information

Non-standard tailor made **C 117-121**
Bestellformular für Sonderwerkzeuge



Solid carbide drills
Vollhartmetallbohrer

Drilling · Bohren

Solid carbide drills · Vollhartmetallbohrer

SL & SLK

Please add K when ordering / Bitte bei der Bestellung K ergänzen

General machining · Allgemeine Bearbeitung
(Deep drill · Tieflochbohrer)

1588SL10C / 1588SL12C / 1588SL15C



1588SL20C / 1588SL30C

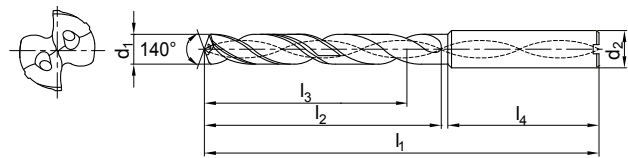
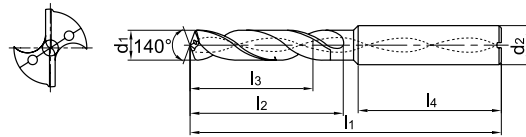

Drilling diameter Bohrerdurchmesser d1 12/15D(m7) 20/30D(h7)	Drilling depth Bohrtiefe (l/d1)	Cooling mode Kühlmittel Internal Intern	Shank Schaft Straight shank Zylinder- schaft	Type Typ	Basic dimension(mm) · Basis Abmessungen					Grade Sorte
					d2(h5)	l1	l2	l3	l4	KDG303
7.2	10	Internal Intern	Straight shank Zylinder- schaft	1588SL10C-0720	8	130	94	84	36	●
	12			1588SL12C-0720	8	146	108	96	36	●
	15			1588SL15C-0720	8	170	130	118	36	○
	20			1588SL20C-0720	8	213	173	155	36	●
	30			1588SL30C-0720	8	290	250	232	36	○
7.3	10			1588SL10C-0730	8	130	94	84	36	●
	12			1588SL12C-0730	8	146	108	96	36	●
	15			1588SL15C-0730	8	170	130	118	36	○
	20			1588SL20C-0730	8	213	173	155	36	○
	30			1588SL30C-0730	8	290	250	232	36	○
7.4	10			1588SL10C-0740	8	130	94	84	36	●
	12			1588SL12C-0740	8	146	108	96	36	●
	15			1588SL15C-0740	8	170	130	118	36	○
	20			1588SL20C-0740	8	213	173	155	36	○
	30			1588SL30C-0740	8	290	250	232	36	○
7.5	10			1588SL10C-0750	8	130	94	84	36	●
	12			1588SL12C-0750	8	146	108	96	36	●
	15			1588SL15C-0750	8	170	130	118	36	○
	20			1588SL20C-0750	8	213	173	155	36	●
	30			1588SL30C-0750	8	290	250	232	36	●
7.6	10			1588SL10C-0760	8	130	94	84	36	●
	12			1588SL12C-0760	8	146	108	96	36	●
	15			1588SL15C-0760	8	180	140	128	36	○
	20			1588SL20C-0760	8	223	183	165	36	○
	30			1588SL30C-0760	8	305	265	246	36	○
7.7	10			1588SL10C-0770	8	130	94	84	36	●
	12			1588SL12C-0770	8	146	108	96	36	●
	15			1588SL15C-0770	8	180	140	128	36	○
	20			1588SL20C-0770	8	223	183	165	36	○
	30			1588SL30C-0770	8	305	265	246	36	○
7.8	10	1588SL10C-0780	8	130	94	84	36	●		
	12	1588SL12C-0780	8	146	108	96	36	●		
	15	1588SL15C-0780	8	180	140	128	36	○		
	20	1588SL20C-0780	8	223	183	165	36	○		
	30	1588SL30C-0780	8	305	265	246	36	●		
7.9	10	1588SL10C-0790	8	130	94	84	36	●		
	12	1588SL12C-0790	8	146	108	96	36	●		
	15	1588SL15C-0790	8	180	140	128	36	○		
	20	1588SL20C-0790	8	223	183	165	36	○		
	30	1588SL30C-0790	8	305	265	246	36	○		
8.0	10	1588SL10C-0800	8	130	94	84	36	●		
	12	1588SL12C-0800	8	146	108	96	36	●		
	15	1588SL15C-0800	8	180	140	128	36	●		
	20	1588SL20C-0800	8	223	183	165	36	●		
	30	1588SL30C-0800	8	305	265	246	36	●		
8.1	10	1588SL10C-0810	10	148	105	94	40	●		
	12	1588SL12C-0810	10	162	120	108	40	●		
	15	1588SL15C-0810	10	194	150	138	40	○		
	20	1588SL20C-0810	10	239	195	176	40	○		
	30	1588SL30C-0810	10	330	285	265	40	○		



Solid carbide drills
Vollhartmetallbohrer

Drilling - Bohren

Solid carbide drills - Vollhartmetallbohrer

Drilling diameter Bohrerdurchmesser d1 12/15D(m7) 20/30D(h7)	Drilling depth Bohrtiefe l(d1)	Cooling mode Kühlmittel.	Shank Schaft	Type Typ	Basic dimension(mm) · Basis Abmessungen					Grade Sorte
					d2(h5)	l1	l2	l3	l4	
										KDG303
8.2	10	Intern Internal	Straight shank Zylinder- schaft	1588SL10C-0820	10	148	105	94	40	●
	12			1588SL12C-0820	10	162	120	108	40	●
	15			1588SL15C-0820	10	194	150	138	40	○
	20			1588SL20C-0820	10	239	195	176	40	○
	30			1588SL30C-0820	10	330	285	265	40	○
8.3	10			1588SL10C-0830	10	148	105	94	40	●
	12			1588SL12C-0830	10	162	120	108	40	●
	15			1588SL15C-0830	10	194	150	138	40	○
	20			1588SL20C-0830	10	239	195	176	40	○
	30			1588SL30C-0830	10	330	285	265	40	○
8.4	10			1588SL10C-0840	10	148	105	94	40	●
	12			1588SL12C-0840	10	162	120	108	40	●
	15			1588SL15C-0840	10	194	150	138	40	○
	20			1588SL20C-0840	10	239	195	176	40	○
	30			1588SL30C-0840	10	330	285	265	40	○
8.5	10	1588SL10C-0850	10	148	105	94	40	●		
	12	1588SL12C-0850	10	162	120	108	40	●		
	15	1588SL15C-0850	10	194	150	138	40	●		
	20	1588SL20C-0850	10	239	195	176	40	●		
	30	1588SL30C-0850	10	330	285	265	40	●		
8.6	10	1588SL10C-0860	10	148	105	94	40	●		
	12	1588SL12C-0860	10	162	120	108	40	●		
	15	1588SL15C-0860	10	204	160	148	40	●		
	20	1588SL20C-0860	10	249	205	186	40	○		
	30	1588SL30C-0860	10	340	295	275	40	○		
8.7	10	1588SL10C-0870	10	148	105	94	40	●		
	12	1588SL12C-0870	10	162	120	108	40	●		
	15	1588SL15C-0870	10	204	160	148	40	○		
	20	1588SL20C-0870	10	249	205	186	40	○		
	30	1588SL30C-0870	10	340	295	275	40	○		
8.8	10	1588SL10C-0880	10	148	105	94	40	●		
	12	1588SL12C-0880	10	162	120	108	40	●		
	15	1588SL15C-0880	10	204	160	148	40	●		
	20	1588SL20C-0880	10	249	205	186	40	○		
	30	1588SL30C-0880	10	340	295	275	40	○		
8.9	10	1588SL10C-0890	10	148	105	94	40	●		
	12	1588SL12C-0890	10	162	120	108	40	●		
	15	1588SL15C-0890	10	204	160	148	40	○		
	20	1588SL20C-0890	10	249	205	186	40	○		
	30	1588SL30C-0890	10	340	295	275	40	○		
9.0	10	1588SL10C-0900	10	148	105	94	40	●		
	12	1588SL12C-0900	10	162	120	108	40	●		
	15	1588SL15C-0900	10	204	160	148	40	●		
	20	1588SL20C-0900	10	249	205	186	40	○		
	30	1588SL30C-0900	10	340	295	275	40	●		
9.1	10	1588SL10C-0910	10	158	115	103	40	●		
	12	1588SL12C-0910	10	174	132	120	40	○		
	15	1588SL15C-0910	10	216	172	160	40	○		
	20	1588SL20C-0910	10	262	218	196	36	○		
	30	1588SL30C-0910	10	360	315	292	40	○		
9.2	10	1588SL10C-0920	10	158	115	103	40	●		
	12	1588SL12C-0920	10	174	132	120	40	●		
	15	1588SL15C-0920	10	216	172	160	40	○		
	20	1588SL20C-0920	10	262	218	196	36	○		
	30	1588SL30C-0920	10	360	315	292	40	○		

Material Overview · Material Übersicht

✓ = Very suitable · Sehr empfohlen
 ✓ = Suitable · Empfohlen

Type Typ	Grade Sorte	Workpiece material · Werkstückstoff									
		Carbon steel Kohlenstoff- Stahl HB≤180	Alloy steel Legierter Stahl	Hardened steel · Gehärteter Stahl			Stainless steel Rostfreier Stahl	Grey cast iron Gusseisen	Nodular cast iron GGG Kugelgra- phitguss	Aluminum alloy Aluleg.	Copper alloy Kupferleg.
			~40HRC	~50HRC	~60HRC						
1588SL*	KDG303	✓	✓	✓			✓	✓	✓	✓	✓
1588SLK*	KDG303							✓			

All articles 1588SLK on demand / Alle Artikel 1588SLK auf Anfrage

Code key **C 8**
ISO Kennzeichen

Cutting data **96-109**
Schnittdaten

Technical Information **C110-116**
Technische Information

Non-standard tailor made **C 117-121**
Bestellformular für Sonderwerkzeuge

Drilling · Bohren

Solid carbide drills · Vollhartmetallbohrer

SL & SLK

General machining · Allgemeine Bearbeitung
(Deep drill · Tieflochbohrer)

Please add K when ordering / Bitte bei der Bestellung K ergänzen

1588SL10C / 1588SL12C / 1588SL15C



1588SL20C / 1588SL30C

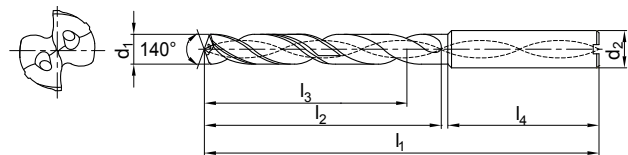
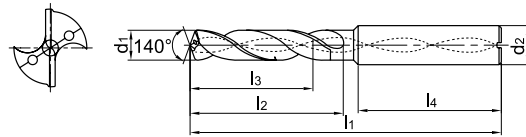

Drilling diameter Bohrerdurchmesser d1 12/15D(m7) 20/30D(h7)	Drilling depth Bohrtiefe l/d1	Cooling mode Kühlmittel.	Shank Schaft	Type Typ	Basic dimension(mm) · Basis Abmessungen					Grade Sorte
					d2(h5)	l1	l2	l3	l4	KDG303
9.3	10	Internal	Straight shank Zylinderschaft	1588SL10C-0930	10	158	115	103	40	●
	12			1588SL12C-0930	10	174	132	120	40	●
	15			1588SL15C-0930	10	216	172	160	40	○
	20			1588SL20C-0930	10	262	218	196	36	○
	30			1588SL30C-0930	10	360	315	292	40	○
9.4	10			1588SL10C-0940	10	158	115	103	40	●
	12			1588SL12C-0940	10	174	132	120	40	●
	15			1588SL15C-0940	10	216	172	160	40	○
	20			1588SL20C-0940	10	262	218	196	36	○
	30			1588SL30C-0940	10	360	315	292	40	○
9.5	10	1588SL10C-0950	10	158	115	103	40	●		
	12	1588SL12C-0950	10	174	132	120	40	●		
	15	1588SL15C-0950	10	216	172	160	40	○		
	20	1588SL20C-0950	10	262	218	196	36	●		
	30	1588SL30C-0950	10	360	315	292	40	●		
9.6	10	1588SL10C-0960	10	158	115	103	40	●		
	12	1588SL12C-0960	10	174	132	120	40	○		
	15	1588SL15C-0960	10	226	182	170	40	○		
	20	1588SL20C-0960	10	272	228	206	40	○		
	30	1588SL30C-0960	10	372	328	305	40	○		
9.7	10	1588SL10C-0970	10	158	115	103	40	●		
	12	1588SL12C-0970	10	174	132	120	40	○		
	15	1588SL15C-0970	10	226	182	170	40	○		
	20	1588SL20C-0970	10	272	228	206	40	○		
	30	1588SL30C-0970	10	372	328	305	40	○		
9.8	10	1588SL10C-0980	10	158	115	103	40	●		
	12	1588SL12C-0980	10	174	132	120	40	●		
	15	1588SL15C-0980	10	226	182	170	40	○		
	20	1588SL20C-0980	10	272	228	206	40	○		
	30	1588SL30C-0980	10	372	328	305	40	○		
9.9	10	1588SL10C-0990	10	158	115	103	40	●		
	12	1588SL12C-0990	10	174	132	120	40	○		
	15	1588SL15C-0990	10	226	182	170	40	○		
	20	1588SL20C-0990	10	272	228	206	40	○		
	30	1588SL30C-0990	10	372	328	305	40	○		
10.0	10	1588SL10C-1000	10	158	115	103	40	●		
	12	1588SL12C-1000	10	174	132	120	40	●		
	15	1588SL15C-1000	10	226	182	170	40	●		
	20	1588SL20C-1000	10	272	228	206	40	●		
	30	1588SL30C-1000	10	372	328	305	40	●		
10.1	10	1588SL10C-1010	12	183	135	121	45	●		
	12	1588SL12C-1010	12	204	156	144	45	●		
	15	1588SL15C-1010	12	240	190	178	45	○		
	20	1588SL20C-1010	12	292	242	220	45	○		
10.2	10	1588SL10C-1020	12	183	135	121	45	●		
	12	1588SL12C-1020	12	204	156	144	45	●		
	15	1588SL15C-1020	12	240	190	178	45	○		
	20	1588SL20C-1020	12	292	242	220	45	○		

C

Solid carbide drills
Vollhartmetallbohrer

Drilling - Bohren

Solid carbide drills · Vollhartmetallbohrer

Drilling diameter Bohrerdurchmesser d1 12/15D(m7) 20/30D(h7)	Drilling depth Bohrtiefe l/d1	Cooling mode Kühlmittel.	Shank Schaft	Type Typ	Basic dimension(mm) · Basis Abmessungen					Grade Sorte
					d2(h5)	l1	l2	l3	l4	
										KDG303
10.3	10	Internal Intern	Straight shank Zylinder- schaft	1588SL10C-1030	12	183	135	121	45	●
	12			1588SL12C-1030	12	204	156	144	45	●
	15			1588SL15C-1030	12	240	190	178	45	○
	20			1588SL20C-1030	12	292	242	220	45	○
10.4	10			1588SL10C-1040	12	183	135	121	45	●
	12			1588SL12C-1040	12	204	156	144	45	●
	15			1588SL15C-1040	12	240	190	178	45	○
	20			1588SL20C-1040	12	292	242	220	45	○
10.5	10			1588SL10C-1050	12	183	135	121	45	●
	12			1588SL12C-1050	12	204	156	144	45	●
	15			1588SL15C-1050	12	240	190	178	45	○
	20			1588SL20C-1050	12	292	242	220	45	●
10.6	10			1588SL10C-1060	12	183	135	121	45	●
	12			1588SL12C-1060	12	204	156	144	45	●
	15			1588SL15C-1060	12	248	198	186	45	○
	20			1588SL20C-1060	12	300	250	228	45	○
10.7	10			1588SL10C-1070	12	183	135	121	45	●
	12			1588SL12C-1070	12	204	156	144	45	○
	15			1588SL15C-1070	12	248	198	186	45	○
	20			1588SL20C-1070	12	300	250	228	45	○
10.8	10			1588SL10C-1080	12	183	135	121	45	●
	12			1588SL12C-1080	12	204	156	144	45	○
	15			1588SL15C-1080	12	248	198	186	45	○
	20			1588SL20C-1080	12	300	250	228	45	○
10.9	10	1588SL10C-1090	12	183	135	121	45	●		
	12	1588SL12C-1090	12	204	156	144	45	○		
	15	1588SL15C-1090	12	248	198	186	45	○		
	20	1588SL20C-1090	12	300	250	228	45	○		
11.0	10	1588SL10C-1100	12	183	135	121	45	●		
	12	1588SL12C-1100	12	204	156	144	45	●		
	15	1588SL15C-1100	12	248	198	186	45	●		
	20	1588SL20C-1100	12	300	250	228	45	●		
11.1	10	1588SL10C-1110	12	183	135	121	45	●		
	12	1588SL12C-1110	12	204	156	144	45	○		
	15	1588SL15C-1110	12	262	212	200	45	○		
	20	1588SL20C-1110	12	315	265	240	45	○		
11.2	10	1588SL10C-1120	12	183	135	121	45	●		
	12	1588SL12C-1120	12	204	156	144	45	●		
	15	1588SL15C-1120	12	262	212	200	45	○		
	20	1588SL20C-1120	12	315	265	240	45	○		
11.3	10	1588SL10C-1130	12	183	135	121	45	●		
	12	1588SL12C-1130	12	204	156	144	45	○		
	15	1588SL15C-1130	12	262	212	200	45	○		
	20	1588SL20C-1130	12	315	265	240	45	○		
11.4	10	1588SL10C-1140	12	183	135	121	45	●		
	12	1588SL12C-1140	12	204	156	144	45	○		
	15	1588SL15C-1140	12	262	212	200	45	○		
	20	1588SL20C-1140	12	315	265	240	45	○		
11.5	10	1588SL10C-1150	12	183	135	121	45	●		
	12	1588SL12C-1150	12	204	156	144	45	●		
	15	1588SL15C-1150	12	262	212	200	45	●		
	20	1588SL20C-1150	12	315	265	240	45	●		
11.6	10	1588SL10C-1160	12	183	135	121	45	●		
	12	1588SL12C-1160	12	204	156	144	45	○		
	15	1588SL15C-1160	12	272	222	210	45	○		
	20	1588SL20C-1160	12	325	275	250	45	○		

Material Overview · Material Übersicht

✓ = Very suitable · Sehr empfohlen
 ✓ = Suitable · Empfohlen

Type Typ	Grade Sorte	Workpiece material · Werkstückstoff									
		Carbon steel Kohlenstoff- Stahl HB≤180	Alloy steel Legierter Stahl	Hardened steel · Gehärteter Stahl			Stainless steel Rostfreier Stahl	Grey cast iron Gusseisen	Nodular cast iron GGG Kugelgra- phitguss	Aluminum alloy Aluleg.	Copper alloy Kupferleg.
			~40HRC	~50HRC	~60HRC						
1588SL*	KDG303	✓	✓	✓			✓	✓	✓	✓	✓
1588SLK*	KDG303							✓			

All articles 1588SLK on demand / Alle Artikel 1588SLK auf Anfrage

Code key C 8
ISO Kennzeichen

Cutting data 96-109
Schnittdaten

Technical Information C110-116
Technische Information

Non-standard tailor made C 117-121
Bestellformular für Sonderwerkzeuge



Solid carbide drills
Vollhartmetallbohrer

Drilling · Bohren

Solid carbide drills · Vollhartmetallbohrer

SL & SLK

Please add K when ordering / Bitte bei der Bestellung K ergänzen

General machining · Allgemeine Bearbeitung
(Deep drill · Tieflochbohrer)

1588SL10C / 1588SL12C / 1588SL15C



1588SL20C / 1588SL30C

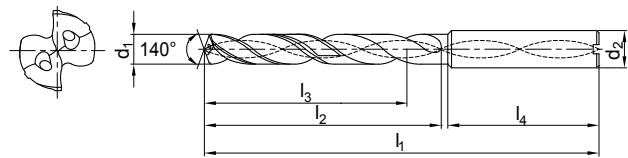
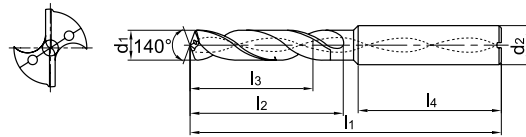

Drilling diameter Bohrerdurchmesser d1 12/15D(m7) 20/30D(h7)	Drilling depth Bohrtiefe l/d1	Cooling mode Kühlmittel.	Shank Schaft	Type Typ	Basic dimension(mm) · Basis Abmessungen					Grade Sorte
					d2(h5)	l1	l2	l3	l4	
										KDG303
11.7	10	Internal Intern	Straight shank Zylinder- schaft	1588SL10C-1170	12	183	135	121	45	●
	12			1588SL12C-1170	12	204	156	144	45	●
	15			1588SL15C-1170	12	272	222	210	45	○
	20			1588SL20C-1170	12	325	275	250	45	○
11.8	10			1588SL10C-1180	12	183	135	121	45	●
	12			1588SL12C-1180	12	204	156	144	45	●
	15			1588SL15C-1180	12	272	222	210	45	○
	20			1588SL20C-1180	12	325	275	250	45	○
11.9	10			1588SL10C-1190	12	183	135	121	45	●
	12			1588SL12C-1190	12	204	156	144	45	○
	15			1588SL15C-1190	12	272	222	210	45	○
	20			1588SL20C-1190	12	325	275	250	45	○
12.0	10			1588SL10C-1200	12	183	135	121	45	●
	12			1588SL12C-1200	12	204	156	144	45	●
	15			1588SL15C-1200	12	272	222	210	45	●
	20			1588SL20C-1200	12	325	275	250	45	○
12.25	10			1588SL10C-1225	14	209	160	144	45	●
12.5	10			1588SL10C-1250	14	209	160	144	45	●
	12			1588SL12C-1250	14	230	182	168	45	●
	20			1588SL20C-1250	14	325	275	250	45	○
	10	1588SL10C-1270	14	209	160	144	45	●		
12.7	12	1588SL12C-1270	14	230	182	168	45	○		
	10	1588SL10C-1275	14	209	160	144	45	●		
12.75	10	1588SL10C-1280	14	209	160	144	45	●		
	12	1588SL12C-1280	14	230	182	168	45	○		
13.0	10	1588SL10C-1300	14	209	160	144	45	●		
	12	1588SL12C-1300	14	230	182	168	45	●		
	20	1588SL20C-1300	14	338	290	265	45	○		
	10	1588SL10C-1310	14	209	160	144	45	●		
13.1	10	1588SL10C-1350	14	209	160	144	45	●		
	12	1588SL12C-1350	14	230	182	168	45	○		
	20	1588SL20C-1350	14	338	290	265	45	○		
13.5	10	1588SL10C-1380	14	209	160	144	45	●		
	10	1588SL10C-1400	14	209	160	144	45	●		
14.0	12	1588SL12C-1400	14	230	182	168	45	●		
	20	1588SL20C-1400	14	367	318	290	45	○		
	12	1588SL12C-1450	16	260	208	194	48	●		
15.0	12	1588SL12C-1500	16	260	208	194	48	●		
15.5	12	1588SL12C-1550	16	260	208	194	48	●		
16.0	12	1588SL12C-1600	16	260	208	194	48	●		
16.5	12	1588SL12C-1650	18	286	234	218	48	●		
17.0	12	1588SL12C-1700	18	286	234	218	48	●		
17.5	12	1588SL12C-1750	18	286	234	218	48	●		
18.0	12	1588SL12C-1800	18	286	234	218	48	●		
18.5	12	1588SL12C-1850	20	310	258	240	48	○		
19.0	12	1588SL12C-1900	20	310	258	240	48	○		
19.5	12	1588SL12C-1950	20	310	258	240	48	○		
20.0	12	1588SL12C-2000	20	310	258	240	48	○		
20.5	12	1588SL12C-2050	22	310	258	240	48	○		
21.0	12	1588SL12C-2100	22	310	258	240	48	○		



Solid carbide drills
Vollhartmetallbohrer

SP series - SP Serie

General machining - Allgemeine Bearbeitung

1534SP03C Pilot drills - Pilotbohrer



Internal Coolant
Interne Kühlung



Straight shank
Zylinderschaft

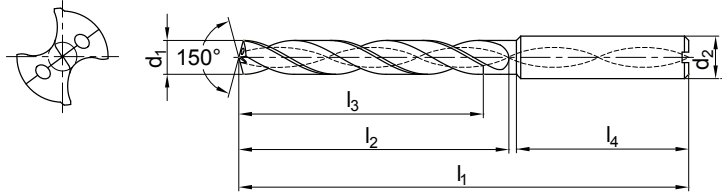

1534SP03C* Drilling diameter Bohrerdurchmesser d1(h7)	Drilling depth Bohrtiefe l/d1	1588SL20C*/30C* Drilling diameter Bohrerdurchmesser d1(h7)	Cooling mode Kühlmittel.	Shank Schaft	Type Typ	Basic dimension(mm) · Basis Abmessungen					Grade Sorte KDG303	
						d2(h6)	l1	l2	l3	l4		
3.03	3	3.0	Internal	Straight shank	1534SP03C-0303	6	62	20	14	36	●	
3.13	3	3.10			1534SP03C-0313	6	62	20	14	36	○	
3.23	3	3.20			1534SP03C-0323	6	62	20	14	36	○	
3.33	3	3.30			1534SP03C-0333	6	62	20	14	36	●	
3.43	3	3.40			1534SP03C-0343	6	62	20	14	36	●	
3.53	3	3.50			1534SP03C-0353	6	62	20	14	36	●	
3.63	3	3.60			1534SP03C-0363	6	62	20	14	36	○	
3.73	3	3.70			1534SP03C-0373	6	62	20	14	36	○	
3.83	3	3.80			1534SP03C-0383	6	66	24	17	36	○	
3.93	3	3.90			1534SP03C-0393	6	66	24	17	36	○	
4.03	3	4.0		1534SP03C-0403	6	66	24	17	36	●		
4.13	3	4.10		1534SP03C-0413	6	66	24	17	36	○		
4.23	3	4.20		1534SP03C-0423	6	66	24	17	36	○		
4.33	3	4.30		1534SP03C-0433	6	66	24	17	36	○		
4.43	3	4.40		Intern	Zylinderschaft	1534SP03C-0443	6	66	24	17	36	○
4.53	3	4.50		1534SP03C-0453		6	66	24	17	36	●	
4.63	3	4.60		1534SP03C-0463		6	66	24	17	36	●	
4.73	3	4.70		1534SP03C-0473		6	66	24	17	36	○	
4.83	3	4.80		1534SP03C-0483		6	66	28	20	36	○	
4.93	3	4.90		1534SP03C-0493		6	66	28	20	36	○	
5.03	3	5.0	1534SP03C-0503	6		66	28	20	36	●		
5.13	3	5.10	1534SP03C-0513	6		66	28	20	36	○		
5.23	3	5.20	1534SP03C-0523	6		66	28	20	36	●		
5.33	3	5.30	1534SP03C-0533	6		66	28	20	36	○		
5.43	3	5.40	1534SP03C-0543	6	66	28	20	36	○			
5.53	3	5.50	1534SP03C-0553	6	66	28	20	36	●			
5.63	3	5.60	1534SP03C-0563	6	66	28	20	36	●			
5.73	3	5.70	1534SP03C-0573	6	66	28	20	36	○			

Material Overview · Material Übersicht

✓ = Very suitable · Sehr empfohlen
 ✓ = Suitable · Empfohlen

Type Typ	Grade Sorte	Workpiece material · Werkstückstoff										
		Carbon steel Kohlenstoff- Stahl HB≤180	Alloy steel Legierter Stahl	Hardened steel · Gehärteter Stahl			Stainless steel Rostfreier Stahl	Grey cast iron Gusseisen	Nodular cast iron GGG Kugelgraphitguss	Aluminum alloy Aluleg.	Copper alloy Kupferleg.	Heat resist. alloy Wärmefeste Leg.
				~40HRC	~50HRC	~60HRC						
1588SL*	KDG303	✓	✓	✓			✓	✓	✓			✓
1588SLK*	KDG303								✓			
1534SP*	KDG303	✓	✓	✓			✓	✓	✓	✓		✓

All articles 1588SLK on demand / Alle Artikel 1588SLK auf Anfrage

Code key **C 8**
ISO Kennzeichen

Cutting data **96-109**
Schnittdaten

Technical Information **C110-116**
Technische Information

Non-standard tailor made **C 117-121**
Bestellformular für Sonderwerkzeuge



Solid carbide drills
Vollhartmetallbohrer

Drilling · Bohren

Solid carbide drills · Vollhartmetallbohrer

SP series · SP Serie

General machining · Allgemeine Bearbeitung

1534SP03C Pilot drills · Pilotbohrer



Internal Coolant
Interne Kühlung



Straight shank
Zylinderschaft

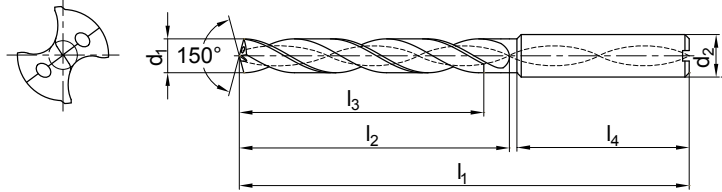

1534SP03C* Drilling diameter Bohrerdurchmesser d ₁ (h7)	Drilling depth Bohrtiefe (l/d ₁)	1588SL20C*/30C* Drilling diameter Bohrerdurchmesser d ₁ (h7)	Cooling mode Kühlmittel.	Shank Schaft	Type Typ	Basic dimension(mm) · Basis Abmessungen					Grade Sorte KDG303
						d ₂ (h ₆)	l ₁	l ₂	l ₃	l ₄	
5.83	3	5.80	Internal	Straight shank Zylinderschaft	1534SP03C-0583	6	66	28	20	36	○
5.93	3	5.90			1534SP03C-0593	6	66	28	20	36	○
6.03	3	6.0			1534SP03C-0603	6	66	28	20	36	●
6.13	3	6.10			1534SP03C-0613	8	79	34	24	36	○
6.23	3	6.20			1534SP03C-0623	8	79	34	24	36	○
6.33	3	6.30			1534SP03C-0633	8	79	34	24	36	●
6.43	3	6.40			1534SP03C-0643	8	79	34	24	36	●
6.53	3	6.50			1534SP03C-0653	8	79	34	24	36	●
6.63	3	6.60			1534SP03C-0663	8	79	34	24	36	○
6.73	3	6.70			1534SP03C-0673	8	79	34	24	36	○
6.83	3	6.80			1534SP03C-0683	8	79	34	24	36	○
6.93	3	6.90			1534SP03C-0693	8	79	34	24	36	○
7.03	3	7.0			1534SP03C-0703	8	79	34	24	36	●
7.13	3	7.10			1534SP03C-0713	8	79	41	29	36	○
7.23	3	7.20			1534SP03C-0723	8	79	41	29	36	○
7.33	3	7.30			1534SP03C-0733	8	79	41	29	36	●
7.43	3	7.40			1534SP03C-0743	8	79	41	29	36	○
7.53	3	7.50			1534SP03C-0753	8	79	41	29	36	●
7.63	3	7.60			1534SP03C-0763	8	79	41	29	36	○
7.73	3	7.70			1534SP03C-0773	8	79	41	29	36	○
7.83	3	7.80	1534SP03C-0783	8	79	41	29	36	○		
7.93	3	7.90	1534SP03C-0793	8	79	41	29	36	○		
8.03	3	8.0	1534SP03C-0803	8	79	41	29	36	●		
8.13	3	8.10	1534SP03C-0813	10	89	47	35	40	○		
8.23	3	8.20	1534SP03C-0823	10	89	47	35	40	○		
8.33	3	8.30	1534SP03C-0833	10	89	47	35	40	○		
8.43	3	8.40	1534SP03C-0843	10	89	47	35	40	○		
8.53	3	8.50	1534SP03C-0853	10	89	47	35	40	●		
8.63	3	8.60	1534SP03C-0863	10	89	47	35	40	●		
8.73	3	8.70	1534SP03C-0873	10	89	47	35	40	●		
8.83	3	8.80	1534SP03C-0883	10	89	47	35	40	●		
8.93	3	8.90	1534SP03C-0893	10	89	47	35	40	○		
9.03	3	9.0	1534SP03C-0903	10	89	47	35	40	●		
9.13	3	9.10	1534SP03C-0913	10	89	47	35	40	○		
9.23	3	9.20	1534SP03C-0923	10	89	47	35	40	○		
9.33	3	9.30	1534SP03C-0933	10	89	47	35	40	○		



Solid carbide drills
Vollhartmetallbohrer

Drilling - Bohren

Solid carbide drills - Vollhartmetallbohrer

1534SP03C* Drilling diameter Bohrerdurchmesser d ₁ (h ₇)	Drilling depth Bohrtiefe l/d ₁	1588SL20C*/30C* Drilling diameter Bohrerdurchmesser d ₁ (h ₇)	Cooling mode Kühlmittel.	Shank Schaft	Type Typ	Basic dimension(mm) · Basis Abmessungen					Grade Sorte KDG303
						d ₂ (h ₆)	l ₁	l ₂	l ₃	l ₄	
9.43	3	9.40	Internal Intern	Straight shank Zylinder- schaft	1534SP03C-0943	10	89	47	35	40	○
9.53	3	9.50			1534SP03C-0953	10	89	47	35	40	●
9.63	3	9.60			1534SP03C-0963	10	89	47	35	40	○
9.73	3	9.70			1534SP03C-0973	10	89	47	35	40	○
9.83	3	9.80			1534SP03C-0983	10	89	47	35	40	●
9.93	3	9.90			1534SP03C-0993	10	89	47	35	40	○
10.03	3	10.0			1534SP03C-1003	10	89	47	35	40	●
10.13	3	10.10			1534SP03C-1013	12	102	55	40	45	●
10.23	3	10.20			1534SP03C-1023	12	102	55	40	45	○
10.33	3	10.30			1534SP03C-1033	12	102	55	40	45	○
10.43	3	10.40			1534SP03C-1043	12	102	55	40	45	○
10.53	3	10.50			1534SP03C-1053	12	102	55	40	45	●
10.63	3	10.60			1534SP03C-1063	12	102	55	40	45	○
10.73	3	10.70			1534SP03C-1073	12	102	55	40	45	○
10.83	3	10.80			1534SP03C-1083	12	102	55	40	45	●
10.93	3	10.90			1534SP03C-1093	12	102	55	40	45	○
11.03	3	11.0			1534SP03C-1103	12	102	55	40	45	●
11.13	3	11.10			1534SP03C-1113	12	102	55	40	45	○
11.23	3	11.20			1534SP03C-1123	12	102	55	40	45	○
11.33	3	11.30			1534SP03C-1133	12	102	55	40	45	○
11.43	3	11.40			1534SP03C-1143	12	102	55	40	45	○
11.53	3	11.50			1534SP03C-1153	12	102	55	40	45	●
11.63	3	11.60			1534SP03C-1163	12	102	55	40	45	○
11.73	3	11.70			1534SP03C-1173	12	102	55	40	45	○
11.83	3	11.80			1534SP03C-1183	12	102	55	40	45	●
11.93	3	11.90			1534SP03C-1193	12	102	55	40	45	○
12.03	3	12.0			1534SP03C-1203	12	102	55	40	45	●
12.13	3	12.10			1534SP03C-1213	14	107	60	43	45	○
12.23	3	12.20			1534SP03C-1223	14	107	60	43	45	○
12.33	3	12.30			1534SP03C-1233	14	107	60	43	45	○
12.43	3	12.40			1534SP03C-1243	14	107	60	43	45	○
12.53	3	12.50			1534SP03C-1253	14	107	60	43	45	●
12.63	3	12.60			1534SP03C-1263	14	107	60	43	45	○
12.73	3	12.70			1534SP03C-1273	14	107	60	43	45	○
12.83	3	12.80	1534SP03C-1283	14	107	60	43	45	○		
12.93	3	12.90	1534SP03C-1293	14	107	60	43	45	○		

Material Overview · Material Übersicht

✓ = Very suitable · Sehr empfohlen

✓ = Suitable · Empfohlen

Type Typ	Grade Sorte	Workpiece material · Werkstückstoff										
		Carbon steel Kohlenstoff- Stahl HB≤180	Alloy steel Legierter Stahl	Hardened steel · Gehärteter Stahl			Stainless steel Rostfreier Stahl	Grey cast iron Gusseisen	Nodular cast iron GGG Kugelgra- phitguss	Aluminum alloy Aluleg.	Copper alloy Kupferleg.	Heat resist. alloy Warmfeste Leg.
				~40HRC	~50HRC	~60HRC						
1534SP*	KDG303	✓	✓	✓			✓	✓	✓	✓		✓

Code key C 8
ISO Kennzeichen

Cutting data 96-109
Schnittdaten

Technical Information C110-116
Technische Information

Non-standard tailor made C 117-121
Bestellformular für Sonderwerkzeuge



Solid carbide drills
Vollhartmetallbohrer

Drilling · Bohren

Solid carbide drills · Vollhartmetallbohrer

1534SP03C* Drilling diameter Bohrerdurchmesser d ₁ (h7)	Drilling depth Bohrtiefe (l/d ₁)	1588SL20C*/30C* Drilling diameter Bohrerdurchmesser d ₁ (h7)	Cooling mode Kühlmittel.	Shank Schaft	Type Typ	Basic dimension(mm) · Basis Abmessungen					Grade Sorte KDG303
						d ₂ (h6)	l ₁	l ₂	l ₃	l ₄	
13.03	3	13.0	Internal Intern	Straight shank Zylinder- schaft	1534SP03C-1303	14	107	60	43	45	○
13.53	3	13.50			1534SP03C-1353	14	107	60	43	45	○
14.03	3	14.0			1534SP03C-1403	14	107	60	43	45	○
14.53	3	14.50			1534SP03C-1453	16	115	65	45	48	○
15.03	3	15.0			1534SP03C-1503	16	115	65	45	48	○
15.53	3	15.50			1534SP03C-1553	16	115	65	45	48	○
16.03	3	16.0			1534SP03C-1603	16	115	65	45	48	○
16.53	3	16.50			1534SP03C-1653	18	123	73	51	48	○
17.03	3	17.0			1534SP03C-1703	18	123	73	51	48	○
17.53	3	17.50			1534SP03C-1753	18	123	73	51	48	○
18.03	3	18.0			1534SP03C-1803	18	123	73	51	48	○
18.53	3	18.50			1534SP03C-1853	20	131	79	55	50	○
19.03	3	19.0			1534SP03C-1903	20	131	79	55	50	○
19.53	3	19.50			1534SP03C-1953	20	131	79	55	50	○
20.03	3	20.0			1534SP03C-2003	20	131	79	55	50	○

✓ = Very suitable · *Sehr empfohlen*
 ✓ = Suitable · *Empfohlen*

Material Overview · Material Übersicht

Type Typ	Grade Sorte	Workpiece material · Werkstückstoff									
		Carbon steel Kohlenstoff- Stahl HB≤180	Alloy steel Legierter Stahl	Hardened steel · Gehärteter Stahl			Stainless steel Rostfreier Stahl	Grey cast iron Gusseisen	Nodular cast iron GGG Kugelgra- phitguss	Aluminum alloy Aluleg.	Copper alloy Kupferleg.
~40HRC	~50HRC			~60HRC							
1534SP*	KDG303	✓	✓	✓			✓	✓	✓	✓	✓

C

Solid carbide drills
Vollhartmetallbohrer

SL series · SL Serie

Recommended cutting data · Schnittdatenempfehlung (Deep drill · Tieflochbohrer)

1 Preparation pilot hole with 1534SP03C*

Herstellung der Pilotbohrung mit 1534SP03C*

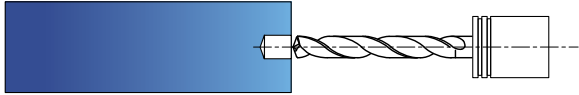

- Top angel of pilot drill must be bigger than SL-drill.
Spitzenwinkel des Pilotbohrers muß größer sein als beim SL-Bohrer.
- Diameter of pilot drill must be 0.01~0.04mm bigger than SL-drill.
Der Durchmesser des Pilotbohrers sollte 0.01~0.04 mm größer sein als beim SL-Bohrer.
- The pilot hole should be 1~3×D.
Tiefe der Pilotbohrung soll 1~3×D betragen.
- V_c: 60-80 m/min; f: 0.1-0.25 mm/r; a_p: 1~3×D

2 Entering into pilot hole with SL-drill

Einführen des SL-Bohrers in die Pilotbohrung

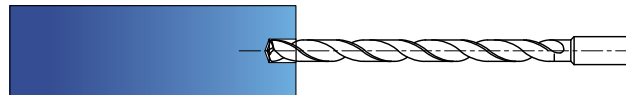

- Entering the pilot hole with low cutting speed. (V_c:20~30m/min)
Den SL-Bohrer mit geringer Drehzahl in die Pilotbohrung einführen. (V_c:20~30 m/min)
- 1~3 mm stop before end of pilot hole. (V_f=0)
1~3 mm vor dem Lochende stehenbleiben. (V_f=0)
- Increase cutting speed up to recommended parameter and than start feed rate.
Die Schnittgeschwindigkeit auf die empfohlenen Parameter erhöhen und erst dann mit dem Vorschub beginnen.

3 Making deep hole

Herstellung der Tieflochbohrung

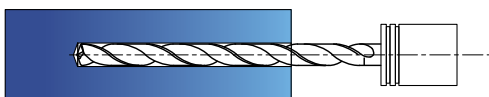

- Drilling with suitable cutting speed and feed rate.
Bohren mit geeigneter Schnittgeschwindigkeit und Vorschüben.
- At cross holes feed rate should be reduced to 0.05 mm/rev..
Bei Querbohrungen den Vorschub auf 0.05 mm/u reduzieren.

4 Pull back of drill

Herausziehen des Bohrers

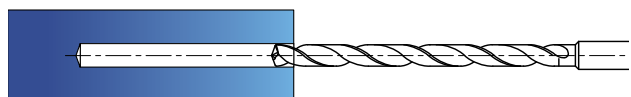

- After reaching the required depth reduce the cutting speed (V_c: 20~30 m/min) and pull back the drill by high feed rate. (V_f: 2000 mm/min)
Nach Erreichen der geforderten Bohrtiefe die Schnittgeschwindigkeit reduzieren (V_c: 20~30 m/min) und den Bohrer mit hohem Vorschub (V_f: 2000 mm/min) herausziehen.

C

Solid carbide drills
Vollhartmetallbohrer

Drilling · Bohren

Solid carbide drills · Vollhartmetallbohrer

NOTES / NOTIZEN:

A series of horizontal dotted lines for taking notes.

C

Solid carbide drills
Vollhartmetallbohrer

ST

series twist drill Spiralbohrer Serie

*For soft steel & stainless steel
Für weichen & rostfreien Stahl*

■ ST special series. A bigger space for chips and its curved edges increases the sharpness of the drills during cutting. Especially suitable for cutting materials with long chips, such as low carbon steels with a high elongation rate and austenitic stainless steel.

Ein definierter Spanraum in Verbindung mit einer scharfen Schneide ermöglicht das Bohren mit einer hohen Produktivität von langspanenden Stahlwerkstoffen und rostfreien Werkstoffen.

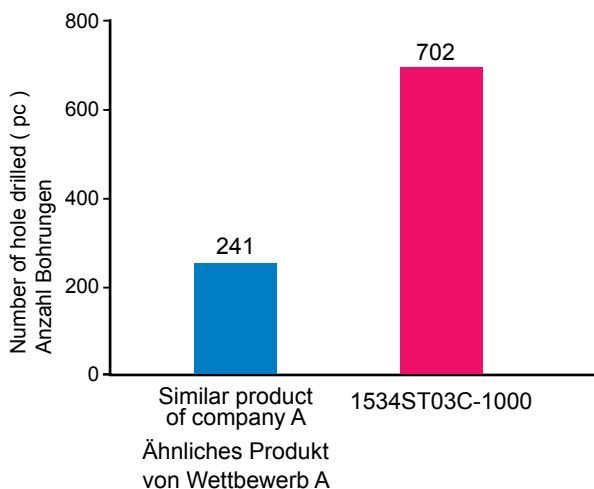

Type / Typ: 1534ST03C-1000
Size / Größe: Ø10mm
Workpiece material
Werkstückstoff: 1Cr18Ni9Ti
Cutting speed / Schnittgeschw.: 70m/min
Rotating speed / Umdrehung pro min: 2200r/min
Feed rate per revolution /
Vorschub pro Umdrehung: 0.15mm/r
Feed rate · Vorschub: 330mm/min
Drilling depth · Bohrtiefe: 30mm(L/D=3)
Cooling system / Kühlsystem
water-soluble liquid (Internal) /
wasserlösliche Emulsion (Intern)
Machine / Maschine: Mikron UCP 1000



Chips (Company A)
(Wettbewerber A)



1534ST03C-1000 chips (ZCC CT)

Drilling · Bohren

Solid carbide drills · Vollhartmetallbohrer

ST series · ST Serie

for soft and stainless steel · für weichen & rostfreien Stahl

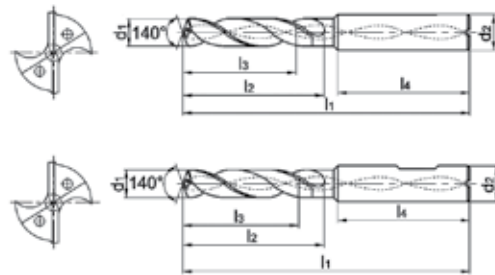

- First choice for drilling soft & stainless steel.
- Sharp cutting edge can avoid build-up edge, suitable for drilling hole with high performance.
- Erste Wahl für das Bohren von weichen und rostfreien Stählen.
- Scharfe Schneiden reduzieren bzw. vermeiden Aufbauschneidenbildung. Besonders geeignet für das Hochleistungsbohren.

Drill diameter Bohrer Ø d1(m7)	Drilling depth Bohrtiefe (L/d1)	Cooling mode Kühlmittel.	Shank Schaft	Type Typ	Basic dimension(mm) · Basis Abmessungen					Grade Sorte KDG303
					Shank diameter Ø Schaftdurchmesser	Overall length Gesamtlänge	Flute length Nutenlänge	effective drill. length Effektive Nutzlänge	Shank length Schaftlänge	
					d2(h6)	l1	l2	l3	l4	
3.0	3	Internal · Intern	Straight shank	1534ST03C-0300	6	62	20	14	36	●
	5		Zylinder	1536ST05C-0300	6	66	28	23	36	●
	5		Weldon	1636ST05C-0300	6	66	28	23	36	○
3.1	3		Straight shank	1534ST03C-0310	6	62	20	14	36	●
	5		Zylinder	1536ST05C-0310	6	66	28	23	36	●
	5		Weldon	1636ST05C-0310	6	66	28	23	36	○
3.2	3		Straight shank	1534ST03C-0320	6	62	20	14	36	●
	5		Zylinder	1536ST05C-0320	6	66	28	23	36	●
	5		Weldon	1636ST05C-0320	6	66	28	23	36	○
3.25	3		Straight shank	1534ST03C-0325	6	62	20	14	36	○
	5		Zylinder	1536ST05C-0325	6	66	28	23	36	○
	5		Weldon	1636ST05C-0325	6	66	28	23	36	○
3.3	3		Straight shank	1534ST03C-0330	6	62	20	14	36	●
	5		Zylinder	1536ST05C-0330	6	66	28	23	36	●
	5		Weldon	1636ST05C-0330	6	66	28	23	36	○
3.4	3		Straight shank	1534ST03C-0340	6	62	20	14	36	●
	5		Zylinder	1536ST05C-0340	6	66	28	23	36	●
	5		Weldon	1636ST05C-0340	6	66	28	23	36	○
3.5	3		Straight shank	1534ST03C-0350	6	62	20	14	36	●
	5		Zylinder	1536ST05C-0350	6	66	28	23	36	●
	5		Weldon	1636ST05C-0350	6	66	28	23	36	○
3.6	3		Straight shank	1534ST03C-0360	6	62	20	14	36	●
	5		Zylinder	1536ST05C-0360	6	66	28	23	36	●
	5		Weldon	1636ST05C-0360	6	66	28	23	36	○
3.7	3	Straight shank	1534ST03C-0370	6	62	20	14	36	●	
	5	Zylinder	1536ST05C-0370	6	66	28	23	36	●	
	5	Weldon	1636ST05C-0370	6	66	28	23	36	○	
3.8	3	Straight shank	1534ST03C-0380	6	66	24	17	36	●	
	5	Zylinder	1536ST05C-0380	6	74	36	29	36	●	
	5	Weldon	1636ST05C-0380	6	74	36	29	36	○	



Solid carbide drills
Vollhartmetallbohrer

Drilling - Bohren

Solid carbide drills - Vollhartmetallbohrer

Drill diameter Bohrer Ø d ₁ (m7)	Drilling depth Bohrtiefe (L/d1)	Cooling mode Kühlmittel.	Shank Schaft	Type Typ	Basic dimension(mm) · Basis Abmessungen					Grade Sorte
					Shank diameter Ø Schaftdurchmesser	Overall length Gesamtlänge	Flute length Nutenlänge	effective drill. length Effektive Nutzlänge	Shank length Schaftlänge	
					d ₂ (h6)	l ₁	l ₂	l ₃	l ₄	KDG303
3.9	3	Internal-Intern	Straight shank Zylinderschaft	1534ST03C-0390	6	66	24	17	36	●
	5		Zylinderschaft	1536ST05C-0390	6	74	36	29	36	●
	5		Weldon shank · Schaft	1636ST05C-0390	6	74	36	29	36	○
4.0	3		Straight shank Zylinderschaft	1534ST03C-0400	6	66	24	17	36	●
	5		Zylinderschaft	1536ST05C-0400	6	74	36	29	36	●
	5		Weldon shank · Schaft	1636ST05C-0400	6	74	36	29	36	○
4.1	3		Straight shank Zylinderschaft	1534ST03C-0410	6	66	24	17	36	●
	5		Zylinderschaft	1536ST05C-0410	6	74	36	29	36	●
	5		Weldon shank · Schaft	1636ST05C-0410	6	74	36	29	36	○
4.2	3		Straight shank Zylinderschaft	1534ST03C-0420	6	66	24	17	36	●
	5		Zylinderschaft	1536ST05C-0420	6	74	36	29	36	●
	5		Weldon shank · Schaft	1636ST05C-0420	6	74	36	29	36	○
4.3	3		Straight shank Zylinderschaft	1534ST03C-0430	6	66	24	17	36	●
	5		Zylinderschaft	1536ST05C-0430	6	74	36	29	36	●
	5		Weldon shank · Schaft	1636ST05C-0430	6	74	36	29	36	○
4.4	3		Straight shank Zylinderschaft	1534ST03C-0440	6	66	24	17	36	●
	5		Zylinderschaft	1536ST05C-0440	6	74	36	29	36	●
	5		Weldon shank · Schaft	1636ST05C-0440	6	74	36	29	36	○
4.5	3		Straight shank Zylinderschaft	1534ST03C-0450	6	66	24	17	36	●
	5		Zylinderschaft	1536ST05C-0450	6	74	36	29	36	●
	5		Weldon shank · Schaft	1636ST05C-0450	6	74	36	29	36	○
4.6	3		Straight shank Zylinderschaft	1534ST03C-0460	6	66	24	17	36	●
	5		Zylinderschaft	1536ST05C-0460	6	74	36	29	36	●
	5		Weldon shank · Schaft	1636ST05C-0460	6	74	36	29	36	○
4.65	3	Straight shank Zylinderschaft	1534ST03C-0465	6	66	24	17	36	○	
	5	Zylinderschaft	1536ST05C-0465	6	74	36	29	36	○	
	5	Weldon shank · Schaft	1636ST05C-0465	6	74	36	29	36	○	
4.7	3	Straight shank Zylinderschaft	1534ST03C-0470	6	66	24	17	36	●	
	5	Zylinderschaft	1536ST05C-0470	6	74	36	29	36	●	
	5	Weldon shank · Schaft	1636ST05C-0470	6	74	36	29	36	○	
4.8	3	Straight shank Zylinderschaft	1534ST03C-0480	6	66	28	20	36	●	
	5	Zylinderschaft	1536ST05C-0480	6	82	44	35	36	●	
	5	Weldon shank · Schaft	1636ST05C-0480	6	82	44	35	36	○	



Solid carbide drills
Vollhartmetallbohrer

Material Overview · Material Übersicht

✓ = Very suitable · Sehr empfohlen
✓ = Suitable · Empfohlen

Grade Sorte	Workpiece material · Werkstückstoff										
	Carbon steel Kohlenstoff- Stahl HB≤180	Alloy steel Legierter Stahl	Hardened steel · Gehärteter Stahl			Stainless steel Rostfreier Stahl	Cast iron Gusseisen	Nodular cast iron GGG Kugelgra- phitguss	Aluminum alloy Aluleg.	Copper alloy Kupferleg.	Heat resist. alloy Wärmefeste Leg.
			~40HRC	~50HRC	~60HRC						
KDG303	✓	✓				✓				✓	

Code key C 8
ISO Kennzeichen

Cutting data 96-109
Schnittdaten

Technical Information C110-116
Technische Information

Non-standard tailor made C 117-121
Bestellformular für Sonderwerkzeuge

Drilling · Bohren

Solid carbide drills · Vollhartmetallbohrer

ST series · ST Serie

for soft and stainless steel · für weichen & rostfreien Stahl

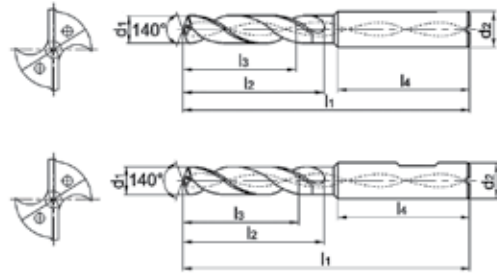

- First choice for drilling soft & stainless steel.
- Sharp cutting edge can avoid build-up edge, suitable for drilling with high performance.
- Erste Wahl für das Bohren von weichen und rostfreien Stählen.
- Scharfe Schneiden reduzieren bzw. vermeiden Aufbauschneidenbildung. Besonders geeignet für das Hochleistungsbohren.

Drill diameter BohrerØ d1(m7)	Drilling depth Bohrtiefe (L/d1)	Cooling mode Kühlmittel.	Shank Schaft	Type Typ	Basic dimension(mm) · Basis Abmessungen					Grade Sorte
					Shank diameter Ø Schaftdurchmesser	Overall length Gesamtlänge	Flute length Nutenlänge	effective drill. length Effektive Nutzlänge	Shank length Schaftlänge	
					d2(h6)	l1	l2	l3	l4	
4.9	3	Internal · Intern	Straight shank Zylinderschaft	1534ST03C-0490	6	66	28	20	36	●
	5			1536ST05C-0490	6	82	44	35	36	●
	5		Weldon shank · Schaft	1636ST05C-0490	6	82	44	35	36	○
5.0	3		Straight shank Zylinderschaft	1534ST03C-0500	6	66	28	20	36	●
	5			1536ST05C-0500	6	82	44	35	36	●
	5		Weldon shank · Schaft	1636ST05C-0500	6	82	44	35	36	○
5.1	3		Straight shank Zylinderschaft	1534ST03C-0510	6	66	28	20	36	●
	5			1536ST05C-0510	6	82	44	35	36	●
	5		Weldon shank · Schaft	1636ST05C-0510	6	82	44	35	36	○
5.2	3		Straight shank Zylinderschaft	1534ST03C-0520	6	66	28	20	36	●
	5			1536ST05C-0520	6	82	44	35	36	●
	5		Weldon shank · Schaft	1636ST05C-0520	6	82	44	35	36	○
5.3	3		Straight shank Zylinderschaft	1534ST03C-0530	6	66	28	20	36	●
	5			1536ST05C-0530	6	82	44	35	36	●
	5		Weldon shank · Schaft	1636ST05C-0530	6	82	44	35	36	○
5.4	3		Straight shank Zylinderschaft	1534ST03C-0540	6	66	28	20	36	●
	5			1536ST05C-0540	6	82	44	35	36	●
	5		Weldon shank · Schaft	1636ST05C-0540	6	82	44	35	36	○
5.5	3	Straight shank Zylinderschaft	1534ST03C-0550	6	66	28	20	36	●	
	5		1536ST05C-0550	6	82	44	35	36	●	
	5	Weldon shank · Schaft	1636ST05C-0550	6	82	44	35	36	○	
5.55	3	Straight shank Zylinderschaft	1534ST03C-0555	6	66	28	20	36	○	
	5		1536ST05C-0555	6	82	44	35	36	○	
	5	Weldon shank · Schaft	1636ST05C-0555	6	82	44	35	36	○	
5.6	3	Straight shank Zylinderschaft	1534ST03C-0560	6	66	28	20	36	●	
	5		1536ST05C-0560	6	82	44	35	36	●	
	5	Weldon shank · Schaft	1636ST05C-0560	6	82	44	35	36	○	
5.7	3	Straight shank Zylinderschaft	1534ST03C-0570	6	66	28	20	36	●	
	5		1536ST05C-0570	6	82	44	35	36	●	
	5	Weldon shank · Schaft	1636ST05C-0570	6	82	44	35	36	○	



Solid carbide drills
Vollhartmetallbohrer

Drilling - Bohren

Solid carbide drills - Vollhartmetallbohrer

Drill diameter Bohrer Ø d ₁ (m7)	Drilling depth Bohrtiefe (L/d ₁)	Cooling mode Kühlmittel.	Shank Schaft	Type Typ	Basic dimension(mm) · Basis Abmessungen					Grade Sorte
					Shank diameter Ø Schaftdurchmesser	Overall length Gesamtlänge	Flute length Nutenlänge	effective drill. length Effektive Nutzlänge	Shank length Schaftlänge	
					d ₂ (h ₆)	l ₁	l ₂	l ₃	l ₄	KDG303
5.8	3	Internal · Intern	Straight shank Zylinderschaft	1534ST03C-0580	6	66	28	20	36	●
	5		Weldon shank · Schaft	1536ST05C-0580	6	82	44	35	36	●
	5		Weldon shank · Schaft	1636ST05C-0580	6	82	44	35	36	○
5.9	3		Straight shank Zylinderschaft	1534ST03C-0590	6	66	28	20	36	●
	5		Weldon shank · Schaft	1536ST05C-0590	6	82	44	35	36	●
	5		Weldon shank · Schaft	1636ST05C-0590	6	82	44	35	36	○
6.0	3		Straight shank Zylinderschaft	1534ST03C-0600	6	66	28	20	36	●
	5		Weldon shank · Schaft	1536ST05C-0600	6	82	44	35	36	●
	5		Weldon shank · Schaft	1636ST05C-0600	6	82	44	35	36	○
6.1	3		Straight shank Zylinderschaft	1534ST03C-0610	8	79	34	24	36	○
	5		Weldon shank · Schaft	1536ST05C-0610	8	91	53	43	36	●
	5		Weldon shank · Schaft	1636ST05C-0610	8	91	53	43	36	○
6.2	3		Straight shank Zylinderschaft	1534ST03C-0620	8	79	34	24	36	●
	5		Weldon shank · Schaft	1536ST05C-0620	8	91	53	43	36	●
	5		Weldon shank · Schaft	1636ST05C-0620	8	91	53	43	36	○
6.3	3		Straight shank Zylinderschaft	1534ST03C-0630	8	79	34	24	36	●
	5		Weldon shank · Schaft	1536ST05C-0630	8	91	53	43	36	●
	5		Weldon shank · Schaft	1636ST05C-0630	8	91	53	43	36	○
6.4	3		Straight shank Zylinderschaft	1534ST03C-0640	8	79	34	24	36	●
	5		Weldon shank · Schaft	1536ST05C-0640	8	91	53	43	36	●
	5		Weldon shank · Schaft	1636ST05C-0640	8	91	53	43	36	○
6.5	3		Straight shank Zylinderschaft	1534ST03C-0650	8	79	34	24	36	●
	5		Weldon shank · Schaft	1536ST05C-0650	8	91	53	43	36	●
	5		Weldon shank · Schaft	1636ST05C-0650	8	91	53	43	36	○
6.6	3	Straight shank Zylinderschaft	1534ST03C-0660	8	79	34	24	36	●	
	5	Weldon shank · Schaft	1536ST05C-0660	8	91	53	43	36	●	
	5	Weldon shank · Schaft	1636ST05C-0660	8	91	53	43	36	○	
6.7	3	Straight shank Zylinderschaft	1534ST03C-0670	8	79	34	24	36	●	
	5	Weldon shank · Schaft	1536ST05C-0670	8	91	53	43	36	●	
	5	Weldon shank · Schaft	1636ST05C-0670	8	91	53	43	36	○	
6.75	3	Straight shank Zylinderschaft	1534ST03C-0675	8	79	34	24	36	○	
	5	Weldon shank · Schaft	1536ST05C-0675	8	91	53	43	36	○	
	5	Weldon shank · Schaft	1636ST05C-0675	8	91	53	43	36	○	
6.80	5	Straight shank Zylinderschaft	1536ST05C-0680	8	91	53	43	36	●	

Material Overview · Material Übersicht

✓ = Very suitable · Sehr empfohlen
 ✓ = Suitable · Empfohlen

Grade Sorte	Workpiece material · Werkstückstoff									
	Carbon steel Kohlenstoff- Stahl HB≤180	Alloy steel Legierter Stahl	Hardened steel · Gehärteter Stahl			Stainless steel Rostfreier Stahl	Cast iron Gusseisen	Nodular cast iron GGG Kugelgra- phitguss	Aluminum alloy Aluleg.	Copper alloy Kupferleg.
~40HRC			~50HRC	~60HRC						
KDG303	✓	✓				✓				✓

Code key C 8
ISO Kennzeichen

Cutting data 96-109
Schnittdaten

Technical Information C110-116
Technische Information

Non-standard tailor made C 117-121
Bestellformular für Sonderwerkzeuge



Solid carbide drills
Vollhartmetallbohrer

Drilling · Bohren

Solid carbide drills · Vollhartmetallbohrer

ST series · ST Serie

for soft and stainless steel · für weichen & rostfreien Stahl

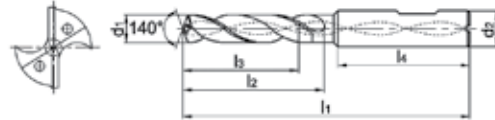
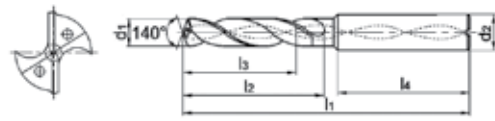

- First choice for drilling soft & stainless steel.
- Sharp cutting edge can avoid build-up edge, suitable for drilling with high performance.
- Erste Wahl für das Bohren von weichen und rostfreien Stählen.
- Scharfe Schneiden reduzieren bzw. vermeiden Aufbauschnittenbildung. Besonders geeignet für das Hochleistungsbohren.

Drill diameter Bohrer Ø d1(m7)	Drilling depth Bohrtiefe (L/d1)	Cooling mode Kühlmittel.	Shank Schaft	Type Typ	Basic dimension(mm) · Basis Abmessungen					Grade Sorte
					Shank diameter Ø Schaftdurchmesser	Overall length Gesamtlänge	Flute length Nutenlänge	effective drill. length Effektive Nutzlänge	Shank length Schaftlänge	
					d2(h6)	l1	l2	l3	l4	
6.9	3	Internal · Intern	Straight shank Zylinderschaft	1534ST03C-0690	8	79	34	24	36	●
	5			1536ST05C-0690	8	91	53	43	36	●
	5		Weld on shank · Schaft	1636ST05C-0690	8	91	53	43	36	○
7.0	3		Straight shank Zylinderschaft	1534ST03C-0700	8	79	34	24	36	●
	5			1536ST05C-0700	8	91	53	43	36	●
	5		Weld on shank · Schaft	1636ST05C-0700	8	91	53	43	36	○
7.1	3		Straight shank Zylinderschaft	1534ST03C-0710	8	79	41	29	36	●
	5			1536ST05C-0710	8	91	53	43	36	●
	5		Weld on shank · Schaft	1636ST05C-0710	8	91	53	43	36	○
7.2	3		Straight shank Zylinderschaft	1534ST03C-0720	8	79	41	29	36	●
	5			1536ST05C-0720	8	91	53	43	36	●
	5		Weld on shank · Schaft	1636ST05C-0720	8	91	53	43	36	○
7.3	3		Straight shank Zylinderschaft	1534ST03C-0730	8	79	41	29	36	●
	5			1536ST05C-0730	8	91	53	43	36	●
	5		Weld on shank · Schaft	1636ST05C-0730	8	91	53	43	36	○
7.4	3		Straight shank Zylinderschaft	1534ST03C-0740	8	79	41	29	36	●
	5			1536ST05C-0740	8	91	53	43	36	●
	5		Weld on shank · Schaft	1636ST05C-0740	8	91	53	43	36	○
7.5	3		Straight shank Zylinderschaft	1534ST03C-0750	8	79	41	29	36	●
	5			1536ST05C-0750	8	91	53	43	36	●
	5		Weld on shank · Schaft	1636ST05C-0750	8	91	53	43	36	○
7.6	3		Straight shank Zylinderschaft	1534ST03C-0760	8	79	41	29	36	●
	5			1536ST05C-0760	8	91	53	43	36	●
	5		Weld on shank · Schaft	1636ST05C-0760	8	91	53	43	36	○
7.7	3	Straight shank Zylinderschaft	1534ST03C-0770	8	79	41	29	36	●	
	5		1536ST05C-0770	8	91	53	43	36	●	
	5	Weld on shank · Schaft	1636ST05C-0770	8	91	53	43	36	○	
7.8	3	Straight shank Zylinderschaft	1534ST03C-0780	8	79	41	29	36	●	
	5		1536ST05C-0780	8	91	53	43	36	●	
	5	Weld on shank · Schaft	1636ST05C-0780	8	91	53	43	36	○	

C

Solid carbide drills
Vollhartmetallbohrer

Drilling - Bohren

Solid carbide drills - Vollhartmetallbohrer

Drill diameter Bohrer Ø d ₁ (m7)	Drilling depth Bohrtiefe (L/d ₁)	Cooling mode Kühlmittel.	Shank Schaft	Type Typ	Basic dimension(mm) · Basis Abmessungen					Grade Sorte
					Shank diameter Ø Schaftdurchmesser	Overall length Gesamtlänge	Flute length Nutenlänge	effective drill. length Effektive Nutzlänge	Shank length Schaftlänge	
					d ₂ (h ₆)	l ₁	l ₂	l ₃	l ₄	KDG303
7.9	3	Internal · Intern	Straight shank Zylinderschaft	1534ST03C-0790	8	79	41	29	36	●
	5			1536ST05C-0790	8	91	53	43	36	●
5	Weldon shank · Schaft		1636ST05C-0790	8	91	53	43	36	○	
8.0	3		Straight shank Zylinderschaft	1534ST03C-0800	8	79	41	29	36	●
	5			1536ST05C-0800	8	91	53	43	36	●
5	Weldon shank · Schaft		1636ST05C-0800	8	91	53	43	36	○	
8.1	3		Straight shank Zylinderschaft	1534ST03C-0810	10	89	47	35	40	●
	5			1536ST05C-0810	10	103	61	49	40	●
5	Weldon shank · Schaft		1636ST05C-0810	10	103	61	49	40	○	
8.2	3		Straight shank Zylinderschaft	1534ST03C-0820	10	89	47	35	40	●
	5			1536ST05C-0820	10	103	61	49	40	●
5	Weldon shank · Schaft		1636ST05C-0820	10	103	61	49	40	○	
8.3	3		Straight shank Zylinderschaft	1534ST03C-0830	10	89	47	35	40	●
	5			1536ST05C-0830	10	103	61	49	40	●
5	Weldon shank · Schaft		1636ST05C-0830	10	103	61	49	40	○	
8.4	3		Straight shank Zylinderschaft	1534ST03C-0840	10	89	47	35	40	●
	5			1536ST05C-0840	10	103	61	49	40	●
5	Weldon shank · Schaft		1636ST05C-0840	10	103	61	49	40	○	
8.5	3		Straight shank Zylinderschaft	1534ST03C-0850	10	89	47	35	40	●
	5			1536ST05C-0850	10	103	61	49	40	●
5	Weldon shank · Schaft		1636ST05C-0850	10	103	61	49	40	○	
8.6	3		Straight shank Zylinderschaft	1534ST03C-0860	10	89	47	35	40	●
	5			1536ST05C-0860	10	103	61	49	40	●
5	Weldon shank · Schaft		1636ST05C-0860	10	103	61	49	40	○	
8.7	3	Straight shank Zylinderschaft	1534ST03C-0870	10	89	47	35	40	●	
	5		1536ST05C-0870	10	103	61	49	40	●	
5	Weldon shank · Schaft	1636ST05C-0870	10	103	61	49	40	○		
8.8	3	Straight shank Zylinderschaft	1534ST03C-0880	10	89	47	35	40	●	
	5		1536ST05C-0880	10	103	61	49	40	●	
5	Weldon shank · Schaft	1636ST05C-0880	10	103	61	49	40	○		
8.9	3	Straight shank Zylinderschaft	1534ST03C-0890	10	89	47	35	40	●	
	5		1536ST05C-0890	10	103	61	49	40	●	
5	Weldon shank · Schaft	1636ST05C-0890	10	103	61	49	40	○		
9.0	3	Straight shank Zylinderschaft	1534ST03C-0900	10	89	47	35	40	○	
	5		1536ST05C-0900	10	103	61	49	40	●	
5	Weldon shank · Schaft	1636ST05C-0900	10	103	61	49	40	○		

Material Overview · Material Übersicht

✓ = Very suitable · Sehr empfohlen
 ✓ = Suitable · Empfohlen

Grade Sorte	Workpiece material · Werkstückstoff									
	Carbon steel Kohlenstoff- Stahl HB≤180	Alloy steel Legierter Stahl	Hardened steel · Gehärteter Stahl			Stainless steel Rostfreier Stahl	Cast iron Gusseisen	Nodular cast iron GGG Kugelgra- phitguss	Aluminum alloy Aluleg.	Copper alloy Kupferleg.
~40HRC			~50HRC	~60HRC						
KDG303	✓	✓				✓				✓

Code key C 8
ISO Kennzeichen

Cutting data 96-109
Schnittdaten

Technical Information C110-116
Technische Information

Non-standard tailor made C 117-121
Bestellformular für Sonderwerkzeuge



Drilling · Bohren

Solid carbide drills · Vollhartmetallbohrer

ST series · ST Serie

for soft and stainless steel · für weichen & rostfreien Stahl

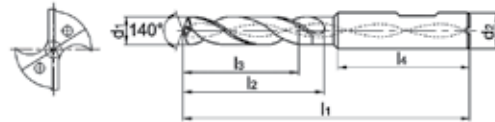
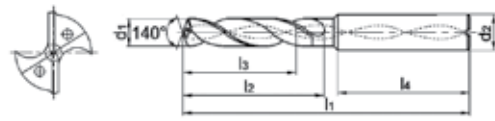

- First choice for drilling soft & stainless steel.
- Sharp cutting edge can avoid build-up edge, suitable for drilling with high performance.
- Erste Wahl für das Bohren von weichen und rostfreien Stählen.
- Scharfe Schneiden reduzieren bzw. vermeiden Aufbauschneidenbildung. Besonders geeignet für das Hochleistungsbohren.

Drill diameter Bohrer Ø d1(m7)	Drilling depth Bohrtiefe (L/d1)	Cooling mode Kühlmittel	Shank Schaft	Type Typ	Basic dimension(mm) · Basis Abmessungen					Grade Sorte KDG303
					Shank diameter Ø Schaftdurchmesser	Overall length Gesamtlänge	Flute length Nutenlänge	effective drill. length Effektive Nutzlänge	Shank length Schaftlänge	
					d2(h6)	l1	l2	l3	l4	
9.1	3	Internal · Intern	Straight shank Zylinderschaft	1534ST03C-0910	10	89	47	35	40	●
	5		Weldon shank · Schaft	1536ST05C-0910	10	103	61	49	40	●
9.2	5		Straight shank Zylinderschaft	1636ST05C-0910	10	103	61	49	40	○
	5		Weldon shank · Schaft	1536ST05C-0920	10	103	61	49	40	●
9.3	3		Straight shank Zylinderschaft	1534ST03C-0930	10	89	47	35	40	●
	5		Weldon shank · Schaft	1536ST05C-0930	10	103	61	49	40	●
9.4	3		Straight shank Zylinderschaft	1534ST03C-0940	10	89	47	35	40	●
	5		Weldon shank · Schaft	1536ST05C-0940	10	103	61	49	40	●
9.5	5		Straight shank Zylinderschaft	1636ST05C-0940	10	103	61	49	40	○
	5		Weldon shank · Schaft	1534ST03C-0950	10	89	47	35	40	●
9.6	3		Straight shank Zylinderschaft	1534ST03C-0950	10	103	61	49	40	●
	5		Weldon shank · Schaft	1636ST05C-0950	10	103	61	49	40	○
9.7	3		Straight shank Zylinderschaft	1534ST03C-0960	10	89	47	35	40	●
	5		Weldon shank · Schaft	1536ST05C-0960	10	103	61	49	40	●
9.8	5		Straight shank Zylinderschaft	1636ST05C-0960	10	103	61	49	40	○
	5		Weldon shank · Schaft	1534ST03C-0970	10	89	47	35	40	●
9.9	3		Straight shank Zylinderschaft	1534ST03C-0970	10	103	61	49	40	●
	5		Weldon shank · Schaft	1636ST05C-0970	10	103	61	49	40	○
10.0	3		Straight shank Zylinderschaft	1636ST05C-0970	10	103	61	49	40	○
	5		Weldon shank · Schaft	1534ST03C-0980	10	89	47	35	40	●
10.1	3		Straight shank Zylinderschaft	1534ST03C-0980	10	103	61	49	40	●
	5		Weldon shank · Schaft	1636ST05C-0980	10	103	61	49	40	○
10.1	5		Straight shank Zylinderschaft	1534ST03C-0990	10	89	47	35	40	●
	5		Weldon shank · Schaft	1536ST05C-0990	10	103	61	49	40	●
10.1	5	Straight shank Zylinderschaft	1636ST05C-0990	10	103	61	49	40	○	
	5	Weldon shank · Schaft	1534ST03C-1000	10	89	47	35	40	●	
10.1	3	Straight shank Zylinderschaft	1534ST03C-1000	10	103	61	49	40	●	
	5	Weldon shank · Schaft	1636ST05C-1000	10	103	61	49	40	○	
10.1	5	Straight shank Zylinderschaft	1636ST05C-1000	10	103	61	49	40	○	
	5	Weldon shank · Schaft	1534ST03C-1010	12	102	55	40	45	●	
10.1	5	Straight shank Zylinderschaft	1536ST05C-1010	12	118	71	56	45	●	
	5	Weldon shank · Schaft	1636ST05C-1010	12	118	71	56	45	○	



Solid carbide drills
Vollhartmetallbohrer

Drilling - Bohren

Solid carbide drills - Vollhartmetallbohrer

Drill diameter Bohrer Ø d ₁ (m7)	Drilling depth Bohrtiefe (L/d1)	Cooling mode Kühlmittel.	Shank Schaft	Type Typ	Basic dimension(mm) · Basis Abmessungen					Grade Sorte
					Shank diameter Ø Schaftdurchmesser	Overall length Gesamtlänge	Flute length Nutenlänge	effective drill. length Effektive Nutzlänge	Shank length Schaftlänge	
					d ₂ (h ₆)	l ₁	l ₂	l ₃	l ₄	KDG303
10.2	5	Internal · Intern	Straight shank Zylinderschaft	1536ST05C-1020	12	118	71	56	45	●
	3			1534ST03C-1025	12	102	55	40	45	●
10.25	5		1536ST05C-1025	12	118	71	56	45	○	
	5		Weldon	1636ST05C-1025	12	118	71	56	45	○
10.3	3		Straight shank Zylinderschaft	1534ST03C-1030	12	102	55	40	45	●
	5			1536ST05C-1030	12	118	71	56	45	●
	5			Weldon	1636ST05C-1030	12	118	71	56	45
10.4	3		Straight shank Zylinderschaft	1534ST03C-1040	12	102	55	40	45	●
	5			1536ST05C-1040	12	118	71	56	45	●
	5			Weldon	1636ST05C-1040	12	118	71	56	45
10.5	3		Straight shank Zylinderschaft	1534ST03C-1050	12	102	55	40	45	○
	5			1536ST05C-1050	12	118	71	56	45	●
	5			Weldon	1636ST05C-1050	12	118	71	56	45
10.6	3		Straight shank Zylinderschaft	1534ST03C-1060	12	102	55	40	45	●
	5			1536ST05C-1060	12	118	71	56	45	●
	5			Weldon	1636ST05C-1060	12	118	71	56	45
10.7	3		Straight shank Zylinderschaft	1534ST03C-1070	12	102	55	40	45	●
	5			1536ST05C-1070	12	118	71	56	45	●
	5			Weldon	1636ST05C-1070	12	118	71	56	45
10.8	3		Straight shank Zylinderschaft	1534ST03C-1080	12	102	55	40	45	●
	5			1536ST05C-1080	12	118	71	56	45	●
	5			Weldon	1636ST05C-1080	12	118	71	56	45
10.9	3		Straight shank Zylinderschaft	1534ST03C-1090	12	102	55	40	45	●
	5			1536ST05C-1090	12	118	71	56	45	●
	5	Weldon		1636ST05C-1090	12	118	71	56	45	○
11.0	3	Straight shank Zylinderschaft	1534ST03C-1100	12	102	55	40	45	●	
	5		1536ST05C-1100	12	118	71	56	45	●	
	5		Weldon	1636ST05C-1100	12	118	71	56	45	○
11.1	3	Straight shank Zylinderschaft	1534ST03C-1110	12	102	55	40	45	●	
	5		1536ST05C-1110	12	118	71	56	45	●	
	5		Weldon	1636ST05C-1110	12	118	71	56	45	○
11.2	3	Straight shank Zylinderschaft	1534ST03C-1120	12	102	55	40	45	●	
	5		1536ST05C-1120	12	118	71	56	45	●	
	5		Weldon	1636ST05C-1120	12	118	71	56	45	○
11.3	3	Straight shank Zylinderschaft	1534ST03C-1130	12	102	55	40	45	●	
	5		1536ST05C-1130	12	118	71	56	45	●	
	5		Weldon	1636ST05C-1130	12	118	71	56	45	○

Material Overview · Material Übersicht

✓ = Very suitable · Sehr empfohlen
 ✓ = Suitable · Empfohlen

Grade Sorte	Workpiece material · Werkstückstoff									
	Carbon steel Kohlenstoff- Stahl HB≤180	Alloy steel Legierter Stahl	Hardened steel · Gehärteter Stahl			Stainless steel Rostfreier Stahl	Cast iron Gusseisen	Nodular cast iron GGG Kugelgra- phitguss	Aluminum alloy Aluleg.	Copper alloy Kupferleg.
~40HRC			~50HRC	~60HRC						
KDG303	✓	✓				✓				✓

Code key C 8
ISO Kennzeichen

Cutting data 96-109
Schnittdaten

Technical Information C110-116
Technische Information

Non-standard tailor made C 117-121
Bestellformular für Sonderwerkzeuge



Solid carbide drills
Vollhartmetallbohrer

Drilling · Bohren

Solid carbide drills · Vollhartmetallbohrer

ST series · ST Serie

for soft and stainless steel · für weichen & rostfreien Stahl

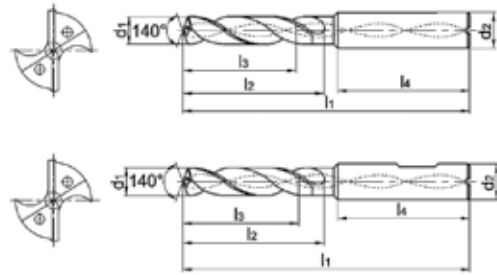

- First choice for drilling soft & stainless steel.
- Sharp cutting edge can avoid build-up edge, suitable for drilling with high performance.
- Erste Wahl für das Bohren von weichen und rostfreien Stählen.
- Scharfe Schneiden reduzieren bzw. vermeiden Aufbauschneidenbildung. Besonders geeignet für das Hochleistungsbohren.

Drill diameter Bohrer Ø d1(m7)	Drilling depth Bohrtiefe (L/d1)	Cooling mode Kühlmittel	Shank Schaft	Type Typ	Basic dimension(mm) · Basis Abmessungen					Grade Sorte
					Shank diameter Ø Schaftdurchmesser	Overall length Gesamtlänge	Flute length Nutenlänge	effective drill. length Effektive Nutzlänge	Shank length Schaftlänge	
					d2(h6)	l1	l2	l3	l4	
11.4	3	Internal · Intern	Straight shank Zylinderschaft	1534ST03C-1140	12	102	55	40	45	●
	5			1536ST05C-1140	12	118	71	56	45	●
	5		Weldon	1636ST05C-1140	12	118	71	56	45	○
11.5	3		Straight shank Zylinderschaft	1534ST03C-1150	12	102	55	40	45	●
	5			1536ST05C-1150	12	118	71	56	45	●
	5		Weldon	1636ST05C-1150	12	118	71	56	45	○
11.6	3		Straight shank Zylinderschaft	1534ST03C-1160	12	102	55	40	45	●
	5			1536ST05C-1160	12	118	71	56	45	●
	5		Weldon	1636ST05C-1160	12	118	71	56	45	○
11.7	3		Straight shank Zylinderschaft	1534ST03C-1170	12	102	55	40	45	●
	5			1536ST05C-1170	12	118	71	56	45	●
	5		Weldon	1636ST05C-1170	12	118	71	56	45	○
11.8	3		Straight shank Zylinderschaft	1534ST03C-1180	12	102	55	40	45	●
	5			1536ST05C-1180	12	118	71	56	45	●
	5		Weldon	1636ST05C-1180	12	118	71	56	45	○
11.9	3		Straight shank Zylinderschaft	1534ST03C-1190	12	102	55	40	45	●
	5			1536ST05C-1190	12	118	71	56	45	●
	5		Weldon	1636ST05C-1190	12	118	71	56	45	○
12.0	3	Straight shank Zylinderschaft	1534ST03C-1200	12	102	55	40	45	●	
	5		1536ST05C-1200	12	118	71	56	45	●	
	5	Weldon	1636ST05C-1200	12	118	71	56	45	○	
12.20	5		1536ST05C-1220	14	124	77	60	45	●	
12.25	3	Straight shank Zylinderschaft	1534ST03C-1225	14	107	60	43	45	●	
	5		1536ST05C-1225	14	124	77	60	45	○	
	5	Weldon	1636ST05C-1225	14	124	77	60	45	○	
12.3	3	Straight shank Zylinderschaft	1534ST03C-1230	14	107	60	43	45	●	
	5		1536ST05C-1230	14	124	77	60	45	●	
	5	Weldon	1636ST05C-1230	14	124	77	60	45	○	
12.5	3	Straight shank Zylinderschaft	1534ST03C-1250	14	107	60	43	45	●	
	5		1536ST05C-1250	14	124	77	60	45	●	
	5	Weldon	1636ST05C-1250	14	124	77	60	45	○	



Solid carbide drills
Vollhartmetallbohrer

Drilling - Bohren

Solid carbide drills - Vollhartmetallbohrer

Drill diameter BohrerØ d1(m7)	Drilling depth Bohrtiefe (L/d1)	Cooling mode Kühlmittel.	Shank Schaft	Type Typ	Basic dimension(mm) · Basis Abmessungen					Grade Sorte
					Shank diameter Ø Schaftdurchmesser	Overall length Gesamtlänge	Flute length Nutenlänge	effective drill. length Effektive Nutzlänge	Shank length Schaftlänge	
					d2(h6)	l1	l2	l3	l4	KDG303
12.7	3	Internal · Intern	Straight shank Zylinderschaft	1534ST03C-1270	14	107	60	43	45	●
	5		Weldon shank · Schaft	1536ST05C-1270	14	124	77	60	45	●
12.75	3		Straight shank Zylinderschaft	1534ST03C-1275	14	107	60	43	45	●
	5		Weldon shank · Schaft	1536ST05C-1275	14	124	77	60	45	○
12.8	3		Straight shank Zylinderschaft	1534ST03C-1280	14	107	60	43	45	●
	5		Weldon shank · Schaft	1536ST05C-1280	14	124	77	60	45	○
13.0	3		Straight shank Zylinderschaft	1534ST03C-1300	14	107	60	43	45	○
	5		Weldon shank · Schaft	1536ST05C-1300	14	124	77	60	45	●
	5		Weldon shank · Schaft	1636ST05C-1300	14	124	77	60	45	○
13.1	3		Straight shank Zylinderschaft	1534ST03C-1310	14	107	60	43	45	●
	5		Weldon shank · Schaft	1536ST05C-1310	14	124	77	60	45	●
	5		Weldon shank · Schaft	1636ST05C-1310	14	124	77	60	45	○
13.5	3		Straight shank Zylinderschaft	1534ST03C-1350	14	107	60	43	45	●
	5		Weldon shank · Schaft	1536ST05C-1350	14	124	77	60	45	●
	5		Weldon shank · Schaft	1636ST05C-1350	14	124	77	60	45	○
13.8	3		Straight shank Zylinderschaft	1534ST03C-1380	14	107	60	43	45	●
	5		Weldon shank · Schaft	1536ST05C-1380	14	124	77	60	45	●
	5		Weldon shank · Schaft	1636ST05C-1380	14	124	77	60	45	○
14.0	3		Straight shank Zylinderschaft	1534ST03C-1400	14	107	60	43	45	●
	5		Weldon shank · Schaft	1536ST05C-1400	14	124	77	60	45	●
	5		Weldon shank · Schaft	1636ST05C-1400	14	124	77	60	45	○
14.25	3		Straight shank Zylinderschaft	1534ST03C-1425	16	115	65	45	48	●
	5		Weldon shank · Schaft	1536ST05C-1425	16	133	83	63	48	○
	5		Weldon shank · Schaft	1636ST05C-1425	16	133	83	63	48	○
14.3	3	Straight shank Zylinderschaft	1534ST03C-1430	16	115	65	45	48	●	
	5	Weldon shank · Schaft	1536ST05C-1430	16	133	83	63	48	●	
	5	Weldon shank · Schaft	1636ST05C-1430	16	133	83	63	48	○	
14.5	3	Straight shank Zylinderschaft	1534ST03C-1450	16	115	65	45	48	●	
	5	Weldon shank · Schaft	1536ST05C-1450	16	133	83	63	48	●	
	5	Weldon shank · Schaft	1636ST05C-1450	16	133	83	63	48	○	
14.75	3	Straight shank Zylinderschaft	1534ST03C-1475	16	115	65	45	48	●	
	5	Weldon shank · Schaft	1536ST05C-1475	16	133	83	63	48	○	
	5	Weldon shank · Schaft	1636ST05C-1475	16	133	83	63	48	○	

Material Overview · Material Übersicht

✓ = Very suitable · Sehr empfohlen
 ✓ = Suitable · Empfohlen

Grade Sorte	Workpiece material · Werkstückstoff									
	Carbon steel Kohlenstoff- Stahl HB≤180	Alloy steel Legierter Stahl	Hardened steel · Gehärteter Stahl			Stainless steel Rostfreier Stahl	Cast iron Gusseisen	Nodular cast iron GGG Kugelgra- phitguss	Aluminum alloy Aluleg.	Copper alloy Kupferleg.
~40HRC			~50HRC	~60HRC						
KDG303	✓	✓				✓				✓

Code key C 8
ISO Kennzeichen

Cutting data 96-109
Schnittdaten

Technical Information C110-116
Technische Information

Non-standard tailor made C 117-121
Bestellformular für Sonderwerkzeuge



Drilling · Bohren

Solid carbide drills · Vollhartmetallbohrer

ST series · ST Serie

for soft and stainless steel · für weichen & rostfreien Stahl

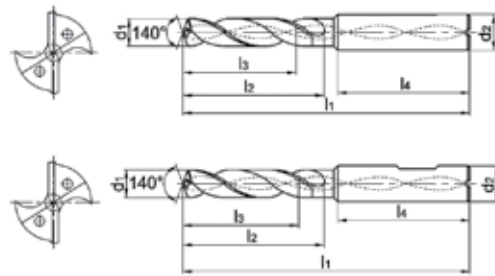

- First choice for drilling soft & stainless steel.
- Sharp cutting edge can avoid build-up edge, suitable for drilling with high performance.
- Erste Wahl für das Bohren von weichen und rostfreien Stählen.
- Scharfe Schneiden reduzieren bzw. vermeiden Aufbauschneidenbildung. Besonders geeignet für das Hochleistungsbohren.

Drill diameter Bohrer Ø d ₁ (m7)	Drilling depth Bohrtiefe (L/d1)	Cooling mode Kühlmittel.	Shank Schaft	Type Typ	Basic dimension(mm) · Basis Abmessungen					Grade Sorte
					Shank diameter Ø Schaftdurchmesser	Overall length Gesamtlänge	Flute length Nutenlänge	Recommended drilling depth	Shank length Schaftlänge	
					d ₂ (h6)	l ₁	l ₂	l ₃	l ₄	KDG303
14.8	3	Internal · Intern	Straight shank Zylinderschaft	1534ST03C-1480	16	115	65	45	48	●
	5			1536ST05C-1480	16	133	83	63	48	●
	5		Weldon	1636ST05C-1480	16	133	83	63	48	○
15.0	3		Straight shank Zylinderschaft	1534ST03C-1500	16	115	65	45	48	●
	5			1536ST05C-1500	16	133	83	63	48	●
	5		Weldon	1636ST05C-1500	16	133	83	63	48	○
15.1	3		Straight shank Zylinderschaft	1534ST03C-1510	16	115	65	45	48	●
	5			1536ST05C-1510	16	133	83	63	48	●
	5		Weldon	1636ST05C-1510	16	133	83	63	48	○
15.5	3		Straight shank Zylinderschaft	1534ST03C-1550	16	115	65	45	48	●
	5			1536ST05C-1550	16	133	83	63	48	●
	5		Weldon	1636ST05C-1550	16	133	83	63	48	○
15.8	3		Straight shank Zylinderschaft	1534ST03C-1580	16	115	65	45	48	●
	5			1536ST05C-1580	16	133	83	63	48	●
	5		Weldon	1636ST05C-1580	16	133	83	63	48	○
16.0	3		Straight shank Zylinderschaft	1534ST03C-1600	16	115	65	45	48	●
	5			1536ST05C-1600	16	133	83	63	48	●
	5		Weldon	1636ST05C-1600	16	133	83	63	48	○
16.5	3	Straight shank Zylinderschaft	1534ST03C-1650	18	123	73	51	48	●	
	5		1536ST05C-1650	18	143	93	71	48	●	
	5	Weldon	1636ST05C-1650	18	143	93	71	48	○	
16.75	3	Straight shank Zylinderschaft	1534ST03C-1675	18	123	73	51	48	●	
	5		1536ST05C-1675	18	143	93	71	48	○	
	5	Weldon	1636ST05C-1675	18	143	93	71	48	○	
16.8	3	Straight shank Zylinderschaft	1534ST03C-1680	18	123	73	51	48	●	
	5		1536ST05C-1680	18	143	93	71	48	●	
	5	Weldon	1636ST05C-1680	18	143	93	71	48	○	
17.0	3	Straight shank Zylinderschaft	1534ST03C-1700	18	123	73	51	48	●	
	5		1536ST05C-1700	18	143	93	71	48	●	
	5	Weldon	1636ST05C-1700	18	143	93	71	48	●	



Solid carbide drills
Vollhartmetallbohrer

Drilling - Bohren

Solid carbide drills - Vollhartmetallbohrer

Drill diameter Bohrer Ø d ₁ (m7)	Drilling depth Bohrtiefe (L/d ₁)	Cooling mode Kühlmittel.	Shank Schaft	Type Typ	Basic dimension(mm) · Basis Abmessungen					Grade Sorte
					Shank diameter Ø Schaftdurchmesser	Overall length Gesamtlänge	Flute length Nutenlänge	effective drill. length Effektive Nutzlänge	Shank length Schaftlänge	
					d ₂ (h ₆)	l ₁	l ₂	l ₃	l ₄	KDG303
17.5	3	Internal · Intern	Straight shank Zylinderschaft	1534ST03C-1750	18	123	73	51	48	●
	5			1536ST05C-1750	18	143	93	71	48	●
5	Weldon shank · Schaft		1636ST05C-1750	18	143	93	71	48	○	
17.8	3		Straight shank Zylinderschaft	1534ST03C-1780	18	123	73	51	48	●
	5			1536ST05C-1780	18	143	93	71	48	●
	5			Weldon shank · Schaft	1636ST05C-1780	18	143	93	71	48
18.0	3		Straight shank Zylinderschaft	1534ST03C-1800	18	123	73	51	48	●
	5			1536ST05C-1800	18	143	93	71	48	●
	5			Weldon shank · Schaft	1636ST05C-1800	18	143	93	71	48
18.5	3		Straight shank Zylinderschaft	1534ST03C-1850	20	131	79	55	50	●
	5			1536ST05C-1850	20	153	101	77	50	●
	5			Weldon shank · Schaft	1636ST05C-1850	20	153	101	77	50
18.8	3		Straight shank Zylinderschaft	1534ST03C-1880	20	131	79	55	50	●
	5			1536ST05C-1880	20	153	101	77	50	●
	5			Weldon shank · Schaft	1636ST05C-1880	20	153	101	77	50
19.0	3		Straight shank Zylinderschaft	1534ST03C-1900	20	131	79	55	50	●
	5			1536ST05C-1900	20	153	101	77	50	●
	5			Weldon shank · Schaft	1636ST05C-1900	20	153	101	77	50
19.5	3		Straight shank Zylinderschaft	1534ST03C-1950	20	131	79	55	50	●
	5			1536ST05C-1950	20	153	101	77	50	●
	5			Weldon shank · Schaft	1636ST05C-1950	20	153	101	77	50
19.8	3		Straight shank Zylinderschaft	1534ST03C-1980	20	131	79	55	50	●
	5			1536ST05C-1980	20	153	101	77	50	●
	5			Weldon shank · Schaft	1636ST05C-1980	20	153	101	77	50
20.0	3	Straight shank Zylinderschaft	1534ST03C-2000	20	131	79	55	50	●	
	5		1536ST05C-2000	20	153	101	77	50	●	
	5		Weldon shank · Schaft	1636ST05C-2000	20	153	101	77	50	○



Solid carbide drills
Vollhartmetallbohrer

Material Overview · Material Übersicht

✓ = Very suitable · Sehr empfohlen
✓ = Suitable · Empfohlen

Grade Sorte	Workpiece material · Werkstückstoff									
	Carbon steel Kohlenstoff- Stahl HB≤180	Alloy steel Legierter Stahl	Hardened steel · Gehärteter Stahl			Stainless steel Rostfreier Stahl	Cast iron Gusseisen	Nodular cast iron GGG Kugelgra- phitguss	Aluminum alloy Aluleg.	Copper alloy Kupferleg.
~40HRC			~50HRC	~60HRC						
KDG303	✓	✓				✓				✓

Code key C 8
ISO Kennzeichen

Cutting data 96-109
Schnittdaten

Technical Information C110-116
Technische Information

Non-standard tailor made C 117-121
Bestellformular für Sonderwerkzeuge

SH

series twist drill Spiralbohrer Serie

**For high hardness steel
Für gehärteten Stahl**

- Uniquely designed chip-breakers and treated with high performance coating render to the drills high rigidity and durability. Especially suitable for the machining of heat treated materials (hardness up to HRC=40-60) and high strength steel (tensile strength 1500N/mm²).
- Speziell entwickelte Spangeometrie in Verbindung mit einer Hochleistungsbeschichtung gibt dem Bohrer die entsprechende Voraussetzung zum Zerspanen von gehärteten Stahl und von hochvergütetem Stahl (Zugfestigkeit 1500N/mm²) (HRC=40-60).



Type · Typ: 1534SH03-1000

Size / Durchmesser: Ø10.0mm

Workpiece material
Werkstückstoff: S136 (53HRC)

Rotating speed
Drehzahl: 800min⁻¹

Cutting speed
Schnittgeschwindigkeit: 25m/min

Feed rate per revolution
Vorschub pro Umdrehung: 0.08mm

Feed rate
Vorschub: 64mm/min

Drilling depth
Bohrtiefe: 20mm (blind hole)

Cooling system: water-soluble liquid
Kühlmittel.: Emulsion

Machine/Maschine: MIKRON UCP 1000

- ◆ 1534SH03-1000
- A company / Wettbewerber A
- ▲ B company / Wettbewerber B

Application of SH series drills in high hardness materials
SH Serie in gehärtetem Stahl

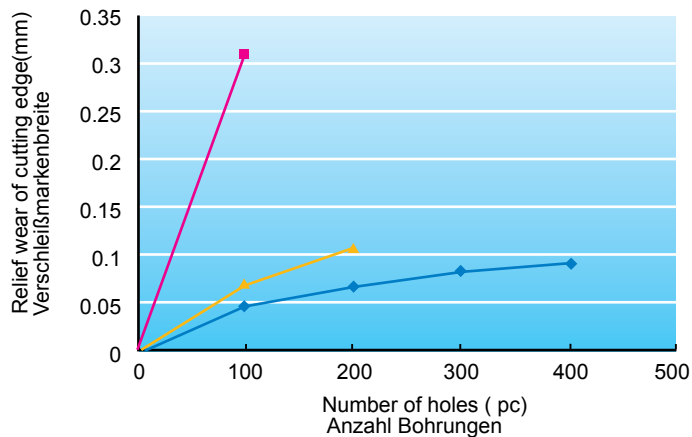

■ Drill wear status in machining process · Verschleiß nach der Bearbeitung

Drill / Bohrer	ZCC 1534SH03-1000	Similar product of company A Vergleichbares Produkt A	Similar product of company B Vergleichbares Produkt B
Number of holes (pc) Bohrungen	400	100	200
Wear value Verschleißmarkenbreite	0.08 mm	Wear 0.31mm fracture 2.59 mm	0.108 mm

Wear
Verschleiß



C

Solid carbide drills
Vollhartmetallbohrer

SH series - SH Serie for high hardness steel · für die Hartbearbeitung

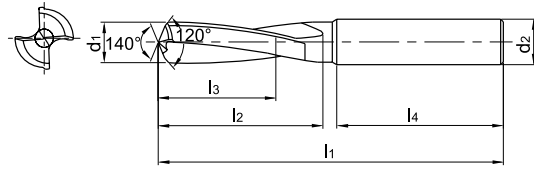

- For drilling high hardness steel (HRC 40~60) and higher tensile strength.
- Small helical angle and large core designed, greatly improve tool rigidity.
- Bohren von gehärteten Stählen (HRC 40-60) und Stählen mit hoher Zugfestigkeit.
- Kleiner Spiralwinkel und größerer Kerndurchmesser (Seele). Erhöht die Werkzeugstabilität deutlich.

Drill diameter Bohrer Ø d1(m7)	Drilling depth Bohrtiefe (L/d1)	Cooling mode Kühlmittel	Shank Schaft	Type Typ	Basic dimension(mm) · Basis Abmessungen					Grade Sorte KDG303
					Shank diameter Ø Schaftdurchmesser	Overall length Gesamtlänge	Flute length Nutenlänge	effective drill. length Effektive Nutzlänge	Shank length Schaftlänge	
					d2(h6)	l1	l2	l3	l4	
3.0	3	External · Extern	Straight shank Zylinderschaft	1534SH03-0300	6	62	20	14	36	●
3.3	3			1534SH03-0330	6	62	20	14	36	●
4.0	3			1534SH03-0400	6	66	24	17	36	●
4.2	3			1534SH03-0420	6	66	24	17	36	●
5.0	3			1534SH03-0500	6	66	28	20	36	●
6.0	3			1534SH03-0600	6	66	28	20	36	●
6.75	3			1534SH03-0675	8	79	34	24	36	●
7.0	3			1534SH03-0700	8	79	34	24	36	●
8.0	3			1534SH03-0800	8	79	41	29	36	●
8.5	3			1534SH03-0850	10	89	47	35	40	●
9.0	3			1534SH03-0900	10	89	47	35	40	●
10.0	3			1534SH03-1000	10	89	47	35	40	●
10.25	3			1534SH03-1025	12	102	55	40	45	●
10.5	3			1534SH03-1050	12	102	55	40	45	●
12.0	3			1534SH03-1200	12	102	55	40	45	●
12.5	3			1534SH03-1250	14	107	60	43	45	●
14.0	3			1534SH03-1400	14	107	60	43	45	●
14.5	3			1534SH03-1450	16	115	65	45	48	●
16.0	3			1534SH03-1600	16	115	65	45	48	●



Solid carbide drills
Vollhartmetallbohrer

● ex Stock Lager · ab Lager ○ on demand · auf Anfrage

Material Overview · Material Übersicht

- ✓ = Very suitable · Sehr empfohlen
- ✓ = Suitable · Empfohlen

Grade Sorte	Workpiece material · Werkstückstoff										
	Mild steel Baustahl HB≤180	Carbon steel Alloy Steel Kohlenstoff- Legierter Stahl	Hardened steel · Gehärteter Stahl			Stainless steel Rostfreier Stahl	Cast iron Gusseisen	Nodular cast iron GGG Kugelgra- phitguss	Aluminum alloy Aluleg.	Copper alloy Kupferleg.	Heat resist. alloy Warmfeste Leg.
			~40HRC	~50HRC	~60HRC						
KDG303			✓	✓	✓						

Code key **C 8**
ISO Kennzeichen

Cutting data **96-109**
Schnittdaten

Technical Information **C110-116**
Technische Information

Non-standard tailor made **C 117-121**
Bestellformular für Sonderwerkzeuge

Drilling · Bohren

Solid carbide drills · Vollhartmetallbohrer

SC series · SC Serie

for cast iron & AL alloy · für Grauguss & Alu-Legierungen



External Coolant
Externe Kühlung



Straight shank
Zylinderschaft

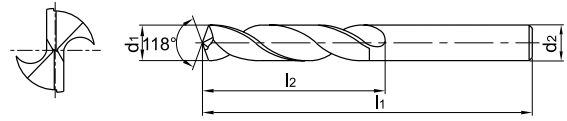

- For materials with short chips such as cast iron, silicon-aluminum alloy etc.
- Cutting edge and shank with same diameter.
- Zur Bearbeitung von kurzspanenden Werkstoffen.
- Gleicher Schneiden- und Schaftdurchmesser.

Drill diameter Bohrer Ø d ₁ (h ₈)	Drilling depth Bohrtiefe (L/d ₁)	Cooling mode Kühlmittel.	Shank Schaft	Type Typ	Basic dimension(mm) · Basis Abmessungen			Grade Sorte
					Shank diameter Ø Schaftdurchmesser	Overall length Gesamtlänge	Flute length Nutenlänge	
					d ₂ (h ₇)	l ₁	l ₂	YK20F
2.0	3	External · Extern	Straight shank Zylinderschaft	1105SC03-0200	2.0	38	12	●
	5			1101SC05-0200	2.0	49	24	○
2.5	3			1105SC03-0250	2.5	43	14	●
	5			1101SC05-0250	2.5	57	30	○
2.8	3			1105SC03-0280	2.8	46	16	●
	5			1101SC05-0280	2.8	61	33	○
3.0	3			1105SC03-0300	3.0	46	16	●
	5			1101SC05-0300	3.0	61	33	○
3.1	3			1105SC03-0310	3.1	49	18	●
3.2	3			1105SC03-0320	3.2	49	18	●
3.3	3			1105SC03-0330	3.3	49	18	●
3.4	3			1105SC03-0340	3.4	52	20	●
3.5	3			1105SC03-0350	3.5	52	20	●
	5			1101SC05-0350	3.5	70	39	○
3.6	3			1105SC03-0360	3.6	52	20	●
3.7	3			1105SC03-0370	3.7	52	20	●
3.8	3			1105SC03-0380	3.8	55	22	●
	5			1101SC05-0380	3.8	75	43	○
3.9	3			1105SC03-0390	3.9	55	22	○
4.0	3			1105SC03-0400	4.0	55	22	●
	5			1101SC05-0400	4.0	75	43	○
4.1	3			1105SC03-0410	4.1	55	22	●
4.2	3			1105SC03-0420	4.2	55	22	●
	5			1101SC05-0420	4.2	75	43	○
4.3	3	1105SC03-0430	4.3	58	24	●		
4.4	3	1105SC03-0440	4.4	58	24	●		
4.5	3	1105SC03-0450	4.5	58	24	●		
	5	1101SC05-0450	4.5	80	47	○		
4.6	3	1105SC03-0460	4.6	58	24	●		
4.7	3	1105SC03-0470	4.7	58	24	○		
4.8	3	1105SC03-0480	4.8	62	26	●		
	5	1101SC05-0480	4.8	86	52	○		
4.9	3	1105SC03-0490	4.9	62	26	●		

C

Solid carbide drills
Vollhartmetallbohrer

Drill diameter Bohrer Ø d ₁ (h ₈)	Drilling depth Bohrtiefe (L/d ₁)	Cooling mode Kühlmittel.	Shank Schaft	Type Typ	Basic dimension(mm) · Basis Abmessungen			Grade Sorte
					Shank diameter Ø Schaftdurchmesser	Overall length Gesamtlänge	Flute length Nutenlänge	
					d ₂ (h ₇)	l ₁	l ₂	YK20F
5.0	3	External · Extern	Straight shank Zylinderschaft	1105SC03-0500	5.0	62	26	●
	5			1101SC05-0500	5.0	86	52	○
5.1	3			1105SC03-0510	5.1	62	26	●
5.2	3			1105SC03-0520	5.2	62	26	●
5.3	3			1105SC03-0530	5.3	62	26	●
5.4	3			1105SC03-0540	5.4	66	28	○
5.5	3			1105SC03-0550	5.5	66	28	●
	5			1101SC05-0550	5.5	93	57	○
5.6	3			1105SC03-0560	5.6	66	28	●
5.7	3			1105SC03-0570	5.7	66	28	●
5.8	3			1105SC03-0580	5.8	66	28	●
	5			1101SC05-0580	5.8	93	57	○
5.9	3			1105SC03-0590	5.9	66	28	○
6.0	3			1105SC03-0600	6.0	66	28	●
	5			1101SC05-0600	6.0	93	57	○
6.1	3			1105SC03-0610	6.1	70	31	●
6.2	3			1105SC03-0620	6.2	70	31	●
6.3	3			1105SC03-0630	6.3	70	31	○
6.4	3			1105SC03-0640	6.4	70	31	●
6.5	3			1105SC03-0650	6.5	70	31	●
	5			1101SC05-0650	6.5	101	63	○
6.6	3			1105SC03-0660	6.6	70	31	●
6.7	3			1105SC03-0670	6.7	70	31	●
6.8	3			1105SC03-0680	6.8	74	34	●
	5			1101SC05-0680	6.8	109	69	○
6.9	3			1105SC03-0690	6.9	74	34	○
7.0	3			1105SC03-0700	7.0	74	34	●
	5			1101SC05-0700	7.0	109	69	○
7.1	3	1105SC03-0710	7.1	74	34	●		
7.2	3	1105SC03-0720	7.2	74	34	○		
7.3	3	1105SC03-0730	7.3	74	34	○		
7.4	3	1105SC03-0740	7.4	74	34	●		



Solid carbide drills
Vollhartmetallbohrer

Material Overview · Material Übersicht

✓ = Very suitable · Sehr empfohlen
✓ = Suitable · Empfohlen

Grade Sorte	Workpiece material · Werkstückstoff										
	Mild steel Baustahl HB≤180	Carbon steel Alloy Steel Kohlenstoff- Legierter Stahl	Hardened steel · Gehärteter Stahl			Stainless steel Rostfreier Stahl	Cast iron Gusseisen	Nodular cast iron GGG Kugelgra- phitguss	Aluminum alloy Aluleg.	Copper alloy Kupferleg.	Heat resist. alloy Warmfeste Leg.
YK20F			~40HRC	~50HRC	~60HRC						
							✓	✓			

Code key **C 8**
ISO Kennzeichen

Cutting data **96-109**
Schnittdaten

Technical Information **C110-116**
Technische Information

Non-standard tailor made **C 117-121**
Bestellformular für Sonderwerkzeuge

Drilling · Bohren

Solid carbide drills · Vollhartmetallbohrer

SC series · SC Serie

for cast iron, AL alloy · für Grauguss & Alu-Legierungen

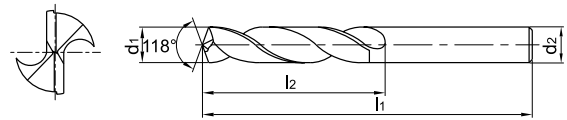

- For materials with short chips such as cast iron, silicon-aluminum alloy etc.
- Cutting edge and shank with same diameter.
- Zur Bearbeitung von kurzspanenden Werkstoffen.
- Gleicher Schneiden- und Schaftdurchmesser.

Drill diameter Bohrer Ø d ₁ (h ₈)	Drilling depth Bohrtiefe (L/d ₁)	Cooling mode Kühlmittel.	Shank Schaft	Type Typ	Basic dimension(mm) · Basis Abmessungen			Grade Sorte
					Shank diameter Ø Schaftdurchmesser	Overall length Gesamtlänge	Flute length Nutenlänge	
					d ₂ (h ₇)	l ₁	l ₂	YK20F
7.5	3	External · Extern	Straight shank Zylinderschaft	1105SC03-0750	7.5	74	34	●
	5			1101SC05-0750	7.5	109	69	○
7.6	3			1105SC03-0760	7.6	79	37	○
7.7	3			1105SC03-0770	7.7	79	37	○
7.8	3			1105SC03-0780	7.8	79	37	●
	5			1101SC05-0780	7.8	117	75	○
7.9	3			1105SC03-0790	7.9	79	37	●
8.0	3			1105SC03-0800	8.0	79	37	●
	5			1101SC05-0800	8.0	117	75	○
8.1	3			1105SC03-0810	8.1	79	37	●
8.2	3			1105SC03-0820	8.2	79	37	●
8.3	3			1105SC03-0830	8.3	79	37	○
8.4	3			1105SC03-0840	8.4	79	37	●
8.5	3			1105SC03-0850	8.5	79	37	●
	5			1101SC05-0850	8.5	117	75	○
8.6	3			1105SC03-0860	8.6	84	40	●
8.7	3			1105SC03-0870	8.7	84	40	●
8.8	3			1105SC03-0880	8.8	84	40	○
	5			1101SC05-0880	8.8	125	81	○
8.9	3			1105SC03-0890	8.9	84	40	○
9.0	3			1105SC03-0900	9.0	84	40	●
	5			1101SC05-0900	9.0	125	81	○
9.1	3			1105SC03-0910	9.1	84	40	●
9.2	3			1105SC03-0920	9.2	84	40	●
9.3	3			1105SC03-0930	9.3	84	40	●
9.4	3			1105SC03-0940	9.4	84	40	○
9.5	3			1105SC03-0950	9.5	84	40	●
	5			1101SC05-0950	9.5	125	81	○
9.6	3	1105SC03-0960	9.6	89	43	○		
9.7	3	1105SC03-0970	9.7	89	43	○		
9.8	3	1105SC03-0980	9.8	89	43	●		
	5	1101SC05-0980	9.8	133	87	○		
9.9	3	1105SC03-0990	9.9	89	43	●		

C

Solid carbide drills
Vollhartmetallbohrer

Drill diameter Bohrer Ø d ₁ (h ₈)	Drilling depth Bohrtiefe (L/d ₁)	Cooling mode Kühlmittel.	Shank Schaft	Type Typ	Basic dimension(mm) · Basis Abmessungen			Grade Sorte
					Shank diameter Ø Schaftdurchmesser	Overall length Gesamtlänge	Flute length Nutenlänge	
					d ₂ (h ₇)	l ₁	l ₂	YK20F
10.0	3	External · Extern	Straight shank Zylinderschaft	1105SC03-1000	10.0	89	43	●
	5			1101SC05-1000	10.0	133	87	○
10.1	3			1105SC03-1010	10.1	89	43	○
10.2	3			1105SC03-1020	10.2	89	43	●
10.4	3			1105SC03-1040	10.4	89	43	○
10.5	3			1105SC03-1050	10.5	89	43	●
	5			1101SC05-1050	10.5	133	87	○
10.7	3			1105SC03-1070	10.7	95	47	○
10.8	3			1105SC03-1080	10.8	95	47	○
	5			1101SC05-1080	10.8	142	94	○
11.0	3			1105SC03-1100	11.0	95	47	●
	5			1101SC05-1100	11.0	142	94	○
11.5	3			1105SC03-1150	11.5	95	47	●
	5			1101SC05-1150	11.5	142	94	○
12.0	3			1105SC03-1200	12.0	102	51	●
	5			1101SC05-1200	12.0	151	101	○
12.5	3			1105SC03-1250	12.5	102	51	●
	5			1101SC05-1250	12.5	151	101	○
12.8	3			1105SC03-1280	12.8	102	51	○
13.0	3			1105SC03-1300	13.0	102	51	●
	5			1101SC05-1300	13.0	151	101	○
13.1	3			1105SC03-1310	13.1	102	51	○
13.5	3			1105SC03-1350	13.5	107	54	○
	5			1101SC05-1350	13.5	160	108	○
14.0	3			1105SC03-1400	14.0	107	54	●
	5			1101SC05-1400	14.0	160	108	○
14.3	3			1105SC03-1430	14.3	111	56	○
14.5	3			1105SC03-1450	14.5	111	56	○
	5			1101SC05-1450	14.5	169	114	○
15.0	3			1105SC03-1500	15.0	111	56	●
	5	1101SC05-1500	15.0	169	114	○		
15.5	5	1101SC05-1550	15.5	178	120	○		
16.0	3	1105SC03-1600	16.0	115	58	●		
	5	1101SC05-1600	16.0	178	120	○		



Solid carbide drills
Vollhartmetallbohrer

Material Overview · Material Übersicht

✓ = Very suitable · Sehr empfohlen
✓ = Suitable · Empfohlen

Grade Sorte	Workpiece material · Werkstückstoff									
	Mild steel Baustahl HB≤180	Carbon steel Alloy Steel Kohlenstoff- Legierter Stahl	Hardened steel · Gehärteter Stahl			Stainless steel Rostfreier Stahl	Cast iron Gusseisen	Nodular cast iron GGG Kugelgra- phitguss	Aluminum alloy Aluleg.	Copper alloy Kupferleg.
YK20F			~40HRC	~50HRC	~60HRC		✓	✓	✓	

Code key **C 8**
ISO Kennzeichen

Cutting data **96-109**
Schnittdaten

Technical Information **C110-116**
Technische Information

Non-standard tailor made **C 117-121**
Bestellformular für Sonderwerkzeuge

Drilling · Bohren

Solid carbide drills · Vollhartmetallbohrer

PA series · PA Serie for AL alloy · für Alu-Legierungen



External Coolant
Externe Kühlung



Straight shank
Zylinderschaft

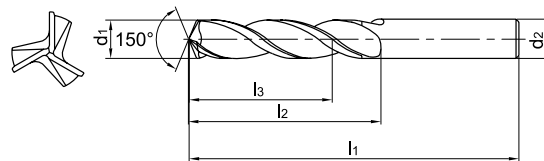

- For drilling solid workpiece composed of Al alloy etc.
- Three-lips structure can achieve high feed rate and prominent centering capability.
- High machining reliability, suitable for poor conditions such as interrupted cutting.
- Bohren von stabilen Werkstücken aus Alu-Legierungen.
- 3-Lippen-Bohrerform ist besonders geeignet für hohe Vorschübe.
- Hohe Bearbeitungssicherheit auch bei ungünstigen Bedingungen (z.B. unterbrochenem Schnitt)

Drill diameter Bohrer Ø d ₁ (h ₇)	Drilling depth Bohrtiefe (L/d ₁)	Cooling mode Kühlmittel.	Shank Schaft	Type Typ	Basic dimension(mm) · Basis Abmessungen				Grade · Sorte	
					Shank diameter Ø Schaftdurchmesser	Overall length Gesamtlänge	Flute length Nutenlänge	effective drill. length Effektive Nutzlänge	KDG303	YK30F
					d ₂ (h ₇)	l ₁	l ₂	l ₃		
3.0	3	External · Extern	Straight shank Zylinderschaft	1165PA03-0300	3.0	46	16	12	●	●
3.1	3			1165PA03-0310	3.1	49	18	14		●
3.2	3			1165PA03-0320	3.2	49	18	14	●	●
3.3	3			1165PA03-0330	3.3	49	18	14	●	
3.4	3			1165PA03-0340	3.4	52	20	15	●	
3.5	3			1165PA03-0350	3.5	52	20	15	●	
3.6	3			1165PA03-0360	3.6	52	20	15		○
3.7	3			1165PA03-0370	3.7	52	20	15		○
3.8	3			1165PA03-0380	3.8	55	22	17	●	
3.9	3			1165PA03-0390	3.9	55	22	17		●
4.0	3			1165PA03-0400	4.0	55	22	17	●	●
4.1	3			1165PA03-0410	4.1	55	22	17	●	
4.2	3			1165PA03-0420	4.2	55	22	17	●	●
4.3	3			1165PA03-0430	4.3	58	24	18	●	●
4.4	3			1165PA03-0440	4.4	58	24	18		○
4.5	3			1165PA03-0450	4.5	58	24	18	●	●
4.6	3			1165PA03-0460	4.6	58	24	18		●
4.7	3			1165PA03-0470	4.7	58	24	18	●	
4.8	3			1165PA03-0480	4.8	62	26	20		○
4.9	3			1165PA03-0490	4.9	62	26	20		●
5.0	3			1165PA03-0500	5.0	62	26	20	●	●
5.1	3			1165PA03-0510	5.1	62	26	20	●	●
5.2	3			1165PA03-0520	5.2	62	26	20	●	●
5.3	3			1165PA03-0530	5.3	62	26	20	●	
5.4	3			1165PA03-0540	5.4	66	28	21		○
5.5	3			1165PA03-0550	5.5	66	28	21	●	●
5.6	3			1165PA03-0560	5.6	66	28	21		●
5.7	3			1165PA03-0570	5.7	66	28	21	●	
5.8	3			1165PA03-0580	5.8	66	28	21	●	
5.9	3			1165PA03-0590	5.9	66	28	21		●
6.0	3			1165PA03-0600	6.0	66	28	21	●	●
6.1	3			1165PA03-0610	6.1	70	31	23		●
6.2	3	1165PA03-0620	6.2	70	31	23		●		



Solid carbide drills
Vollhartmetallbohrer

Drilling · Bohren

Solid carbide drills · Vollhartmetallbohrer

Drill diameter Bohrer Ø d ₁ (h7)	Drilling depth Bohrtiefe (L/d ₁)	Cooling mode Kühlmittel.	Shank Schaft	Type Typ	Basic dimension(mm) · Basis Abmessungen				Grade · Sorte	
					Shank diameter Ø Schaftdurchmesser	Overall length Gesamtlänge	Flute length Nutenlänge	effective drill. length Effektive Nutzlänge	KDG303	YK30F
					d ₂ (h7)	l ₁	l ₂	l ₃		
6.3	3	External · Extern	Straight shank Zylinder-schaft	1165PA03-0630	6.3	70	31	23		○
6.4	3			1165PA03-0640	6.4	70	31	23	●	○
6.5	3			1165PA03-0650	6.5	70	31	23	●	●
6.6	3			1165PA03-0660	6.6	70	31	23	●	●
6.7	3			1165PA03-0670	6.7	70	31	23	●	
6.8	3			1165PA03-0680	6.8	74	34	25	●	●
6.9	3			1165PA03-0690	6.9	74	34	25		●
7.0	3			1165PA03-0700	7.0	74	34	25	●	●
7.1	3			1165PA03-0710	7.1	74	34	25		○
7.2	3			1165PA03-0720	7.2	74	34	25		○
7.3	3			1165PA03-0730	7.3	74	34	25		○
7.4	3			1165PA03-0740	7.4	74	34	25	●	
7.5	3			1165PA03-0750	7.5	74	34	25	○	
7.6	3			1165PA03-0760	7.6	79	37	27		●
7.7	3			1165PA03-0770	7.7	79	37	27		○
7.8	3			1165PA03-0780	7.8	79	37	27		●
7.9	3			1165PA03-0790	7.9	79	37	27		○
8.0	3			1165PA03-0800	8.0	79	37	27	●	●
8.1	3			1165PA03-0810	8.1	79	37	27	●	
8.2	3			1165PA03-0820	8.2	79	37	27		●
8.3	3			1165PA03-0830	8.3	79	37	27		○
8.4	3			1165PA03-0840	8.4	79	37	27		○
8.5	3			1165PA03-0850	8.5	79	37	27	●	●
8.6	3			1165PA03-0860	8.6	84	40	29		●
8.7	3			1165PA03-0870	8.7	84	40	29	●	
8.8	3			1165PA03-0880	8.8	84	40	29		○
8.9	3			1165PA03-0890	8.9	84	40	29		○
9.0	3			1165PA03-0900	9.0	84	40	29	●	●
9.1	3			1165PA03-0910	9.1	84	40	29		○
9.2	3			1165PA03-0920	9.2	84	40	29		○
9.3	3			1165PA03-0930	9.3	84	40	29		○
9.4	3			1165PA03-0940	9.4	84	40	29		○
9.5	3	1165PA03-0950	9.5	84	40	29	●			
9.6	3	1165PA03-0960	9.6	89	43	31		○		
9.7	3	1165PA03-0970	9.7	89	43	31		○		
9.8	3	1165PA03-0980	9.8	89	43	31	●			



Solid carbide drills
Vollhartmetallbohrer

Material Overview · Material Übersicht

✓ = Very suitable · Sehr empfohlen
✓ = Suitable · Empfohlen

Grade Sorte	Workpiece material · Werkstückstoff										
	Mild steel Baustahl HB≤180	Carbon steel, Alloy steel Kohlenstoff-, Legierter Stahl	Hardened steel · gehärteter Stahl			Stainless steel Rostfreier Stahl	gray Cast iron Gusseisen	Nodular cast iron GGG Kugelgra- phitguss	Aluminum alloy Aluleg.	Copper alloy Kupferleg.	Heat resist. alloy Warmfeste Leg.
			~40HRC	~50HRC	~60HRC						
KDG303						✓		✓		✓	
YK30F						✓		✓		✓	

Code key C 8
ISO Kennzeichen

Cutting data 96-109
Schnittdaten

Technical Information C110-116
Technische Information

Non-standard tailor made C 117-121
Bestellformular für Sonderwerkzeuge

Drilling · Bohren

Solid carbide drills · Vollhartmetallbohrer

PA series · PA Serie for AL alloy · für Alu-Legierungen



External Coolant
Externe Kühlung

Straight shank
Zylinderschaft

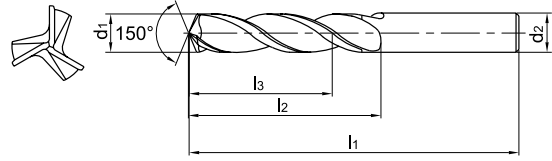

- For drilling solid workpiece composed of Al alloy etc.
- Three-lips structure can achieve high feed rate and prominent centering capability.
- High machining reliability, suitable for poor conditions such as interrupted cutting.
- Bohren von stabilen Werkstücken aus Alu - Legierungen.
- 3 Lippen Bohrerform ist besonders geeignet für hohe Vorschübe.
- Hohe Bearbeitungssicherheit auch bei ungünstigen Bedingungen (z.B. unterbrochenem Schnitt)

Drill diameter Bohrer Ø d ₁ (h7)	Drilling depth Bohrtiefe (L/d1)	Cooling mode Kühlmittel.	Shank Schaft	Type Typ	Basic dimension(mm) · Basis Abmessungen				Grade · Sorte	
					Shank diameter Ø Schaftdurchmesser	Overall length Gesamtlänge	Flute length Nutenlänge	effective drill. length Effektive Nutzlänge	KDG303	YK30F
					d ₂ (h7)	l ₁	l ₂	l ₃		
9.9	3	External · Extern	Straight shank Zylinder-schaft	1165PA03-0990	9.9	89	43	31		●
10.0	3			1165PA03-1000	10.0	89	43	31	●	●
10.1	3			1165PA03-1010	10.1	89	43	31		○
10.2	3			1165PA03-1020	10.2	89	43	31	●	
10.3	3			1165PA03-1030	10.3	89	43	31	●	
10.5	3			1165PA03-1050	10.5	89	43	31	●	
11.0	3			1165PA03-1100	11.0	95	47	33	○	●
11.2	3			1165PA03-1120	11.2	95	47	33		○
11.5	3			1165PA03-1150	11.5	95	47	33	○	
11.8	3			1165PA03-1180	11.8	95	47	33	○	○
12.0	3			1165PA03-1200	12.0	102	51	35	●	●
12.1	3			1165PA03-1210	12.1	102	51	35		○
12.5	3			1165PA03-1250	12.5	102	51	35	●	○
13.0	3			1165PA03-1300	13.0	102	51	35		●
13.5	3			1165PA03-1350	13.5	107	54	37	○	
14.0	3			1165PA03-1400	14.0	107	54	37	●	
14.5	3			1165PA03-1450	14.5	111	56	38	●	
15.0	3			1165PA03-1500	15.0	111	56	38	●	
15.5	3			1165PA03-1550	15.5	115	58	38		○
16.0	3			1165PA03-1600	16.0	115	58	38	●	
16.5	3	1165PA03-1650	16.5	119	60	39		○		
17.0	3	1165PA03-1700	17.0	119	60	39		●		
17.5	3	1165PA03-1750	17.5	123	62	40		○		
18.0	3	1165PA03-1800	18.0	123	62	40	●	●		
18.5	3	1165PA03-1850	18.5	127	64	41		○		
19.0	3	1165PA03-1900	19.0	127	64	41		○		
19.5	3	1165PA03-1950	19.5	131	66	42		○		
20.0	3	1165PA03-2000	20.0	131	66	42		○		

Material Overview · Material Übersicht

✓ = Very suitable · Sehr empfohlen
✓ = Suitable · Empfohlen

Grade Sorte	Workpiece material · Werkstückstoff										
	Mild steel Baustahl HB≤180	Carbon steel, Alloy steel Kohlenstoff-, Legierter Stahl	Hardened steel · gehärteter Stahl			Stainless steel Rostfreier Stahl	gray Cast iron Gusseisen	Nodular cast iron GGG Kugelgra- phitguss	Aluminum alloy Alulég.	Copper alloy Kupferleg.	Heat resist. alloy Warmfeste Leg.
			~40HRC	~50HRC	~60HRC						
KDG303						✓	✓	✓		✓	
YK30F						✓	✓	✓		✓	



Solid carbide drills
Vollhartmetallbohrer

PC series · PC Serie

for cast iron, AL alloy · für Grauguss & Alu-Legierungen

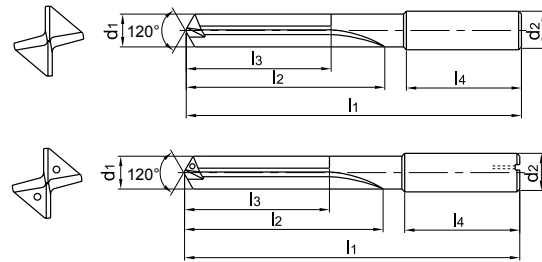
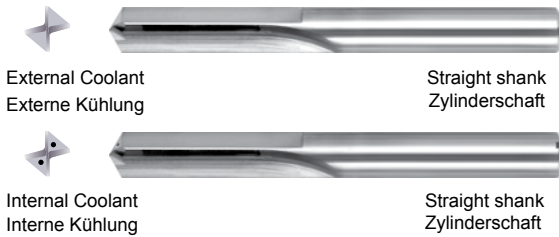

- For materials with short chips such as cast iron, silicon-aluminum alloy etc.
- Excellent self centering capability can machine high efficiently, and the hole precision can reach H7.
- High positional accuracy, high linearity and good surface finish can be obtained in the hole drilled.
- Bearbeitung von kurzspanenden Werkstoffen wie Grauguss, Silizium-Alu-Legierungen etc.
- Exzellente Zentrierungseigenschaften für hocheffiziente Bearbeitung, Bohrungsqualität bis H7.
- Hohe Genauigkeit, hohe Zentrität und gute Oberflächenqualität werden auf der gesamten Bohrungslänge erzielt.

Drill diameter Bohrer Ø d1(m7)	Drilling depth Bohrtiefe (L/d1)	Cooling mode Kühlmittel	Shank Schaft	Type Typ	Basic dimension(mm) · Basis Abmessungen					Grade Sorte
					Shank diameter Ø Schaftdurchmesser	Overall length Gesamtlänge	Flute length Nutenlänge	effective drill. length Effektive Nutzlänge	Shank length Schaftlänge	
					d2(h6)	l1	l2	l3	l4	
4.0	5	External·Extern	Straight shank Zylinderschaft	1576PC05-0400	6.0	74	36	29	36	●
		Internal·Intern		1576PC05C-0400	6.0	74	36	29	36	●
4.2	5	External·Extern		1576PC05-0420	6.0	74	36	29	36	○
		Internal·Intern		1576PC05C-0420	6.0	74	36	29	36	●
5.0	5	External·Extern		1576PC05-0500	6.0	82	44	35	36	●
		Internal·Intern		1576PC05C-0500	6.0	82	44	35	36	●
	15	Internal·Intern		1579PC15C-0500	6.0	145	105	96	36	○
6.0	5	External·Extern		1576PC05-0600	6.0	82	44	35	36	●
		Internal·Intern		1576PC05C-0600	6.0	82	44	35	36	●
	15	Internal·Intern		1579PC15C-0600	6.0	145	105	96	36	○
6.75	5	External·Extern		1576PC05-0675	8.0	91	53	43	36	●
		Internal·Intern		1576PC05C-0675	8.0	91	53	43	36	●
7.0	5	External·Extern		1576PC05-0700	8.0	91	53	43	36	○
		Internal·Intern		1576PC05C-0700	8.0	91	53	43	36	●
8.0	5	External·Extern		1576PC05-0800	8.0	91	53	43	36	●
		Internal·Intern		1576PC05C-0800	8.0	91	53	43	36	●
	15	Internal·Intern		1579PC15C-0800	8.0	180	137	127	36	○
8.5	5	External·Extern		1576PC05-0850	10.0	103	61	49	40	●
		Internal·Intern		1576PC05C-0850	10.0	103	61	49	40	●
9.0	5	External·Extern		1576PC05-0900	10.0	103	61	49	40	○
		Internal·Intern		1576PC05C-0900	10.0	103	61	49	40	●
	15	Internal·Intern		1579PC15C-0900	10.0	217	170	158	40	○

Material Overview · Material Übersicht

✓ = Very suitable · Sehr empfohlen
 ✓ = Suitable · Empfohlen

Grade Sorte	Workpiece material · Werkstückstoff									
	Mild steel Baustahl HB≤180	Carbon steel Alloy Steel Kohlenstoff- Legierter Stahl	Hardened steel · Gehärteter Stahl			Stainless steel Rostfreier Stahl	Cast iron Gusseisen	Nodular cast iron GGG Kugelgra- phitguss	Aluminum alloy Aluleg.	Copper alloy Kupferleg.
YK20F			~40HRC	~50HRC	~60HRC		✓	✓	✓	

Code key C 8
ISO Kennzeichen

Cutting data 96-109
Schnittdaten

Technical Information C110-116
Technische Information

Non-standard tailor made C 117-121
Bestellformular für Sonderwerkzeuge

Drilling · Bohren

Solid carbide drills · Vollhartmetallbohrer

PC series · PC Serie

for cast iron, AL alloy · für Grauguss & Alu-Legierungen

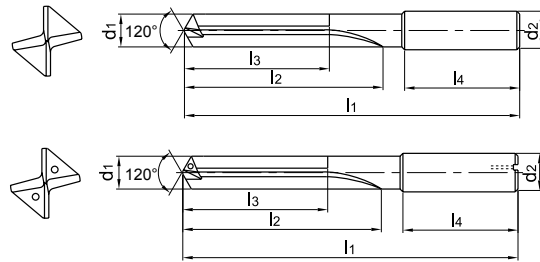

- For materials with short chips such as cast iron, silicon-aluminum alloy etc.
- Excellent self centering capability can machine high efficiently, and the hole precision can reach H7.
- High positional accuracy, high linearity and good surface finish can be obtained in the hole drilled.
- Bearbeitung von kurzspanenden Werkstoffen wie Grauguss, Silizium-Alu-Legierungen etc.
- Exzellente Zentrierungseigenschaften für hocheffiziente Bearbeitung, Bohrungsqualität bis H7.
- Hohe Genauigkeit, hohe Zentrität und gute Oberflächenqualität werden auf der gesamten Bohrungslänge erzielt.

Drill diameter Bohrer Ø d1(m7)	Drilling depth Bohrtiefe (L/d1)	Cooling mode Kühlmittel	Shank Schaft	Type Typ	Basic dimension(mm) · Basis Abmessungen					Grade Sorte
					Shank diameter Ø Schaftdurchmesser	Overall length Gesamtlänge	Flute length Nutenlänge	effective drill. length Effektive Nutzlänge	Shank length Schaftlänge	
					d2(h6)	l1	l2	l3	l4	
10.0	5	External·Extern	Straight shank Zylinder- schaft	1576PC05-1000	10.0	103	61	49	40	●
		Internal·Intern		1576PC05C-1000	10.0	103	61	49	40	●
15	Internal·Intern	1579PC15C-1000		10.0	217	170	158	40	○	
10.25	5	External·Extern		1576PC05-1025	12.0	118	71	56	45	○
		Internal·Intern		1576PC05C-1025	12.0	118	71	56	45	●
11.0	5	External·Extern		1576PC05-1100	12.0	118	71	56	45	○
		Internal·Intern		1576PC05C-1100	12.0	118	71	56	45	●
15	Internal·Intern	1579PC15C-1100		12.0	258	205	190	45	○	
		1576PC05-1200		12.0	118	71	56	45	○	
12.0	5	Internal·Intern		1576PC05C-1200	12.0	118	71	56	45	●
		1579PC15C-1200		12.0	258	205	190	45	○	
13.0	5	External·Extern		1576PC05-1300	14.0	124	77	60	45	○
		Internal·Intern		1576PC05C-1300	14.0	124	77	60	45	●
14.0	5	External·Extern		1576PC05-1400	14.0	124	77	60	45	○
		Internal·Intern		1576PC05C-1400	14.0	124	77	60	45	●
		1579PC15C-1400		14.0	290	236	219	45	○	
15.0	5	External·Extern		1576PC05-1500	16.0	133	83	63	48	○
		Internal·Intern		1576PC05C-1500	16.0	133	83	63	48	○
15.5	5	External·Extern		1576PC05-1550	16.0	133	83	63	48	○
		Internal·Intern		1576PC05C-1550	16.0	133	83	63	48	○
16.0	5	External·Extern		1576PC05-1600	16.0	133	83	63	48	●
		Internal·Intern		1576PC05C-1600	16.0	133	83	63	48	○
17.0	5	External·Extern		1576PC05-1700	18.0	143	93	71	48	○
		Internal·Intern		1576PC05C-1700	18.0	143	93	71	48	○
17.5	5	External·Extern	1576PC05-1750	18.0	143	93	71	48	○	
		Internal·Intern	1576PC05C-1750	18.0	143	93	71	48	○	
18.0	5	External·Extern	1576PC05-1800	18.0	143	93	71	48	○	
		Internal·Intern	1576PC05C-1800	18.0	143	93	71	48	●	
19.5	5	External·Extern	1576PC05-1950	20.0	153	101	77	50	○	
		Internal·Intern	1576PC05C-1950	20.0	153	101	77	50	○	
20.0	5	External·Extern	1576PC05-2000	20.0	153	101	77	50	○	
		Internal·Intern	1576PC05C-2000	20.0	153	101	77	50	●	

PC series - PC Serie

for cast iron & AL alloy · für Grauguss & Alu-Legierungen

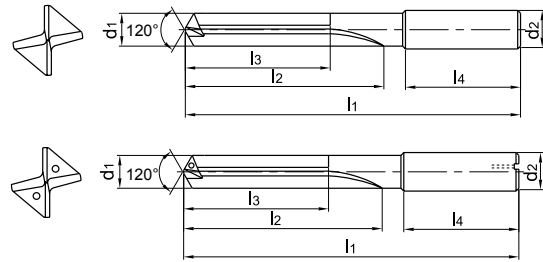

- For materials with short chips such as cast iron, silicon-aluminum alloy etc.
- Excellent self centering capability can machine high efficiently, and the hole precision can reach H7.
- High positional accuracy, high linearity and good surface finish can be obtained in the hole drilled.
- Bearbeitung von kurzspanenden Werkstoffen wie Grauguss, Silizium - Alu - Legierungen etc.
- Exzellente Zentrierungseigenschaften für hocheffiziente Bearbeitung, Bohrungsqualität bis H7.
- Hohe Genauigkeit, hohe Zentrität und gute Oberflächenqualität werden auf der gesamten Bohrungslänge erzielt.

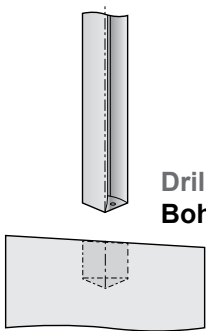

**Drill inclined face
Bohren in Schrägen**

Please reduce the feed rate correspondingly to the basis of recommended parameters when drilling inclined or curved face.

Bitte beim Bohren in Schrägen oder balligen Flächen den Vorschub entsprechend reduzieren.

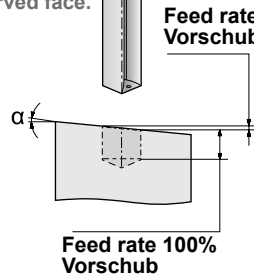

**Feed rate
Vorschub**

Inclined angle α Neigungswinkel	Max. feed rate Max.Vorschub
1°	80%
2°	50%
3°	30%

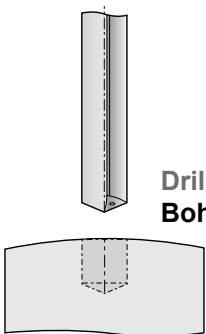

**Drill curved face
Bohren in balligen Flächen**

Pretreatment should be carried out when the face possess a large inclined angle, drill hole at the flat face which milled firstly.

Beim Bohren in sehr großen schrägen Flächen ist eine Vorbearbeitung zu empfehlen (Anfasen).

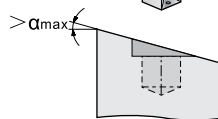

Material Overview · Material Übersicht

- ✓ = Very suitable · Sehr empfohlen
- ✓ = Suitable · Empfohlen

Grade Sorte	Workpiece material · Werkstückstoff									
	Mild steel Baustahl HB≤180	Carbon steel Alloy Steel Kohlenstoff-, Legierter Stahl	Hardened steel · Gehärteter Stahl			Stainless steel Rostfreier Stahl	Cast iron Gusseisen	Nodular cast iron GGG Kugelgrah- phitguss	Aluminum alloy Aluleg.	Copper alloy Kupferleg.
YK20F			~40HRC	~50HRC	~60HRC		✓	✓	✓	

Code key **C 8**
ISO Kennzeichen

Cutting data **96-109**
Schnittdaten

Technical Information **C110-116**
Technische Information

Non-standard tailor made **C 117-121**
Bestellformular für Sonderwerkzeuge

Drilling · Bohren

Solid carbide drills · Vollhartmetallbohrer

SC series · SC Serie

for steel, stainless steel, cast iron and non-ferrous material
für Stahl, rostfreier Stahl, Gusswerkstoffe und NE-Metalle

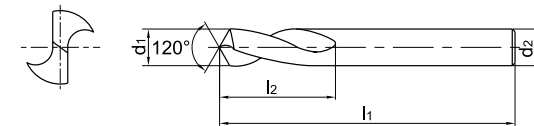
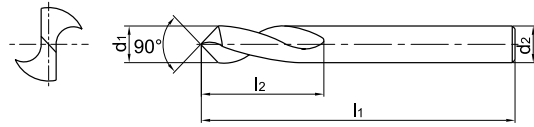

- Suitable for drilling center hole and chamfer.
- Comparing with common centering drills, it possesses more stable centering capability. Even at the slant face, it is also easy to carry out center drilling.
- Zum Zentrierbohren und Fasen.
- Die Bohrer sind in ihrer Stabilität höher im Vergleich zu normalen Zentrierbohrern.

Drill diameter Bohrer Ø d ₁ (h ₆)	Point angle Spitzenwinkel	Cooling mode Kühlmittel	Shank Schaft	Type Typ	Basic dimension(mm) · Basis Abmessungen			Grade Sorte	
					Shank diameter Ø Schaftdurchmesser	Overall length Gesamtlänge	Flute length Nutenlänge	YK30F	KDG303
					d ₂ (h ₆)	l ₁	l ₂		
5	90°	External Extern	Straight shank Zylinder- schaft	1143SC90-0500	5.00	62	10	○	●
	120°			1143SC120-0500	5.00	62	10	○	●
6	90°			1143SC90-0600	6.00	66	15	○	●
	120°			1143SC120-0600	6.00	66	15	○	●
8	90°			1143SC90-0800	8.00	79	17	○	●
	120°			1143SC120-0800	8.00	79	17	○	●
10	90°			1143SC90-1000	10.00	89	20	○	●
	120°			1143SC120-1000	10.00	89	20	○	●
12	90°			1143SC90-1200	12.00	102	25	○	●
	120°			1143SC120-1200	12.00	102	25	○	●
14	90°			1143SC90-1400	14.00	107	30	○	●
	120°			1143SC120-1400	14.00	107	30	○	●
16	90°			1143SC90-1600	16.00	115	35	○	●
	120°			1143SC120-1600	16.00	115	35	○	●
20	90°			1143SC90-2000	20.00	131	40	○	●
	120°			1143SC120-2000	20.00	131	40	○	●

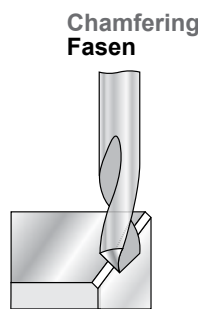
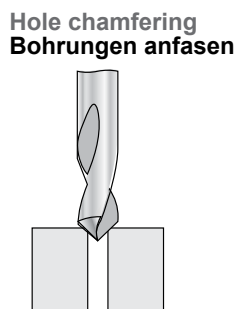
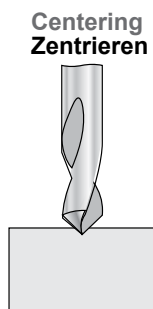

Material Overview · Material Übersicht

✓ = Very suitable · Sehr empfohlen
✓ = Suitable · Empfohlen

Grade Sorte	Workpiece material · Werkstückstoff									
	Mild steel Baustahl HB≤180	Carbon steel Alloy Steel Kohlenstoff-, Legierter Stahl	Hardened steel · Gehärteter Stahl			Stainless steel Rostfreier Stahl	Cast iron Gusseisen	Nodular cast iron GGG Kugelgra- phitguss	Aluminum alloy Aluleg.	Copper alloy Kupferleg.
			~40HRC	~50HRC	~60HRC					
YK20F	✓	✓					✓	✓	✓	
KDG303	✓	✓	✓	✓		✓	✓	✓	✓	✓

Solid carbide drills
Vollhartmetallbohrer

Drilling · Bohren

Recommended cutting data · Schnittdatenempfehlung

SU series twist drills · SU Spiralbohrer Serie (External coolant / Externe Kühlung)

3D

5D

Workpiece material Werkstückstoff	Mild steel Baustahl HB≤180	Carbon steel, alloy steel Kohlenstoffstahl Leg. Stahl ~30HRC	Pre-hardened steel Vergüteter Stahl ~40HRC	Stainless steel Rostfreier Stahl	Cast iron Gusseisen	Nodular cast iron GGG Kugelgraphitguss	Aluminum alloy Alulegierungen	Heat resistant alloy Warmfeste Legierungen								
Vc	60~120m/min	60~120m/min	40~70m/min	25~40m/min	60~120m/min	50~100m/min	60~140m/min	15~25m/min								
Ø (mm)	n (min ⁻¹)	f (mm/r)	n (min ⁻¹)	f (mm/r)	n (min ⁻¹)	f (mm/r)	n (min ⁻¹)	f (mm/r)	n (min ⁻¹)	f (mm/r)	n (min ⁻¹)	f (mm/r)	n (min ⁻¹)	f (mm/r)	n (min ⁻¹)	f (mm/r)
2	14000	0.06~ 0.08	14000	0.06~ 0.08	9500	0.06~ 0.08	5500	0.02~ 0.05	14000	0.06~ 0.08	11000	0.06~ 0.08	16000	0.06~ 0.08	3200	0.02~ 0.04
3	9500	0.09~ 0.12	9500	0.09~ 0.12	6300	0.09~ 0.12	3700	0.03~ 0.07	9500	0.09~ 0.12	7400	0.09~ 0.12	10600	0.09~ 0.12	2100	0.03~ 0.06
4	7000	0.10~ 0.15	7000	0.10~ 0.15	4700	0.10~ 0.15	2700	0.04~ 0.08	7000	0.10~ 0.15	5600	0.10~ 0.15	8000	0.10~ 0.15	1600	0.04~ 0.07
5	5700	0.12~ 0.18	5700	0.12~ 0.18	3800	0.12~ 0.18	2200	0.05~ 0.10	5700	0.12~ 0.18	4500	0.12~ 0.18	6400	0.12~ 0.18	1250	0.05~ 0.09
6	4700	0.14~ 0.20	4700	0.14~ 0.20	3100	0.14~ 0.20	1850	0.06~ 0.12	4700	0.14~ 0.20	3700	0.14~ 0.20	5300	0.14~ 0.20	1050	0.06~ 0.11
8	3600	0.16~ 0.24	3600	0.16~ 0.24	2400	0.16~ 0.24	1400	0.08~ 0.16	3600	0.16~ 0.24	2800	0.16~ 0.24	4000	0.16~ 0.24	800	0.08~ 0.14
10	2800	0.18~ 0.27	2800	0.18~ 0.27	1900	0.18~ 0.27	1100	0.10~ 0.18	2800	0.18~ 0.27	2200	0.18~ 0.27	3200	0.18~ 0.27	600	0.10~ 0.16
12	2400	0.20~ 0.30	2400	0.20~ 0.30	1600	0.20~ 0.30	930	0.12~ 0.20	2400	0.20~ 0.30	1900	0.20~ 0.30	2700	0.20~ 0.30	500	0.12~ 0.18
14	2100	0.22~ 0.35	2100	0.22~ 0.35	1400	0.22~ 0.35	800	0.13~ 0.22	2100	0.22~ 0.35	1600	0.22~ 0.35	2300	0.22~ 0.35	450	0.13~ 0.20
16	1800	0.25~ 0.36	1800	0.25~ 0.36	1200	0.25~ 0.36	700	0.14~ 0.25	1800	0.25~ 0.36	1400	0.25~ 0.36	2000	0.25~ 0.36	400	0.14~ 0.23
18	1600	0.28~ 0.38	1600	0.28~ 0.38	1100	0.28~ 0.38	620	0.15~ 0.28	1600	0.28~ 0.38	1200	0.28~ 0.38	1800	0.28~ 0.38	350	0.15~ 0.25
20	1400	0.30~ 0.40	1400	0.30~ 0.40	950	0.30~ 0.40	550	0.16~ 0.30	1400	0.30~ 0.40	1100	0.30~ 0.40	1600	0.30~ 0.40	320	0.16~ 0.28

1. When the tool is used for the first time, please make a test cutting with 90% of cutting speed or 85% feed rate mentioned above. If the cutting conditions remain stable, gradually increase the cutting speed and feed rate.
2. The cutting conditions above are for drilling with emulsion.
3. Use a collet without any defect or dust. The radial run-out of drill must be under 0.02mm.
4. These conditions above are for cutting depth under 5D.

1. Beim ersten Einsatz 90% der empfohlenen Schnittgeschwindigkeit oder 85% des Vorschubes wählen. Bei stabiler Bearbeitung die Schnittdaten entsprechend erhöhen.
2. Die obigen Schnittdatenempfehlungen basieren auf dem Einsatz von Emulsion.
3. Keine defekte Werkzeugaufnahme wählen. Die Rundlaufgenauigkeit muss unter 0,02mm liegen.
4. Die obigen Schnittdaten sind für Bohrungstiefen unter 5xD ausgelegt.

C

Solid carbide drills
Vollhartmetallbohrer

SU series twist drills · SU Spiralbohrer Serie (Internal coolant / Interne Kühlung)

3D

5D

Workpiece material Werkstückstoff	Mild steel Baustahl HB≤180		Carbon steel, alloy steel Kohlenstoffstahl Leg. Stahl ~30HRC		Pre-hardened steel Vergüteter Stahl ~40HRC		Stainless steel Rostfreier Stahl		Cast iron Gusseisen		Nodular cast iron GGG Kugelgraphitguss		Aluminum alloy Alulegierungen		Heat resistant alloy Warmfeste Legierungen	
Vc	80~150m/min		80~150m/min		50~80m/min		50~80m/min		80~150m/min		60~120m/min		100~180m/min		15~25m/min	
Ø (mm)	n (min ⁻¹)	f (mm/r)	n (min ⁻¹)	f (mm/r)	n (min ⁻¹)	f (mm/r)	n (min ⁻¹)	f (mm/r)	n (min ⁻¹)	f (mm/r)	n (min ⁻¹)	f (mm/r)	n (min ⁻¹)	f (mm/r)	n (min ⁻¹)	f (mm/r)
3	12700	0.09~ 0.12	12700	0.09~ 0.12	7400	0.09~ 0.12	6300	0.03~ 0.07	12700	0.09~ 0.12	9500	0.09~ 0.12	15000	0.09~ 0.12	2100	0.03~ 0.06
4	9600	0.10~ 0.15	9600	0.10~ 0.15	5600	0.10~ 0.15	4700	0.04~ 0.08	9600	0.10~ 0.15	7000	0.10~ 0.15	11100	0.10~ 0.15	1600	0.04~ 0.07
5	7600	0.12~ 0.18	7600	0.12~ 0.18	4500	0.12~ 0.18	3800	0.05~ 0.10	7600	0.12~ 0.18	5700	0.12~ 0.18	9000	0.12~ 0.18	1250	0.05~ 0.09
6	6400	0.14~ 0.20	6400	0.14~ 0.20	3700	0.14~ 0.20	3200	0.06~ 0.12	6400	0.14~ 0.20	4700	0.14~ 0.20	7400	0.14~ 0.20	1050	0.06~ 0.11
8	4800	0.16~ 0.24	4800	0.16~ 0.24	2800	0.16~ 0.24	2400	0.08~ 0.16	4800	0.16~ 0.24	3600	0.16~ 0.24	5600	0.16~ 0.24	800	0.08~ 0.14
10	3800	0.18~ 0.27	3800	0.18~ 0.27	2200	0.18~ 0.27	1900	0.10~ 0.18	3800	0.18~ 0.27	2800	0.18~ 0.27	4500	0.18~ 0.27	600	0.10~ 0.16
12	3200	0.20~ 0.30	3200	0.20~ 0.30	1900	0.20~ 0.30	1600	0.12~ 0.20	3200	0.20~ 0.30	2400	0.20~ 0.30	3700	0.20~ 0.30	500	0.12~ 0.18
14	2700	0.22~ 0.35	2700	0.22~ 0.35	1600	0.22~ 0.35	1350	0.13~ 0.22	2700	0.22~ 0.35	2100	0.22~ 0.35	3200	0.22~ 0.35	450	0.13~ 0.20
16	2400	0.25~ 0.36	2400	0.25~ 0.36	1400	0.25~ 0.36	1200	0.14~ 0.25	2400	0.25~ 0.36	1800	0.25~ 0.36	2800	0.25~ 0.36	400	0.14~ 0.23
18	2100	0.28~ 0.38	2100	0.28~ 0.38	1200	0.28~ 0.38	1050	0.15~ 0.28	2100	0.28~ 0.38	1600	0.28~ 0.38	2500	0.28~ 0.38	350	0.15~ 0.25
20	1900	0.30~ 0.40	1900	0.30~ 0.40	1100	0.30~ 0.40	950	0.16~ 0.30	1900	0.30~ 0.40	1400	0.30~ 0.40	2300	0.30~ 0.40	320	0.16~ 0.28

1. When the tool is used for the first time, please make a test cutting with 90% of cutting speed or 85% feed rate mentioned above. If the cutting conditions remain stable, gradually increase the cutting speed and feed rate.
2. The cutting conditions above are for drilling with emulsion.
3. Use a collet without any defect or dust. The radial run-out of drill must be under 0.02mm.
4. These conditions above are for cutting depth under 5D.

1. Beim ersten Einsatz 90% der empfohlenen Schnittgeschwindigkeit oder 85% des Vorschubes wählen. Bei stabiler Bearbeitung die Schnittdaten entsprechend erhöhen.
2. Die obigen Schnittdatenempfehlungen basieren auf dem Einsatz von Emulsion.
3. Keine defekte Werkzeugaufnahme wählen. Die Rundlaufgenauigkeit muss unter 0,02mm liegen.
4. Die obigen Schnittdaten sind für Bohrungstiefen unter 5xD ausgelegt.



Drilling - Bohren

Recommended cutting data - Schnittdatenempfehlung

SU series twist drills - SU Spiralbohrer Serie (Internal coolant / Interne Kühlung)

8D

Workpiece material Werkstückstoff	Mild steel Baustahl HB≤180		Carbon steel, alloy steel Kohlenstoffstahl Leg. Stahl ~30HRC		Pre-hardened steel Vergüteter Stahl ~40HRC		Stainless steel Rostfreier Stahl		Cast iron Gusseisen		Nodular cast iron GGG Kugelgraphitguss		Aluminum alloy Alulegierungen		Heat resistant alloy Warmfeste Legierungen	
Vc	80~150m/min		80~150m/min		50~80m/min		40~60m/min		80~150m/min		60~120m/min		100~180m/min		15~25m/min	
Ø (mm)	n (min ⁻¹)	f (mm/r)	n (min ⁻¹)	f (mm/r)	n (min ⁻¹)	f (mm/r)	n (min ⁻¹)	f (mm/r)	n (min ⁻¹)	f (mm/r)	n (min ⁻¹)	f (mm/r)	n (min ⁻¹)	f (mm/r)	n (min ⁻¹)	f (mm/r)
3	12700	0.06~ 0.10	12700	0.06~ 0.10	7400	0.06~ 0.10	5300	0.03~ 0.07	12700	0.06~ 0.10	9500	0.06~ 0.10	15000	0.09~ 0.12	2100	0.03~ 0.06
4	9600	0.08~ 0.12	9600	0.08~ 0.12	5600	0.08~ 0.12	4000	0.04~ 0.08	9600	0.08~ 0.12	7000	0.08~ 0.12	11100	0.10~ 0.15	1600	0.04~ 0.07
5	7600	0.10~ 0.14	7600	0.10~ 0.14	4500	0.10~ 0.14	3200	0.05~ 0.10	7600	0.10~ 0.14	5700	0.10~ 0.14	9000	0.10~ 0.14	1250	0.05~ 0.09
6	6400	0.11~ 0.16	6400	0.11~ 0.16	3700	0.11~ 0.16	2700	0.06~ 0.12	6400	0.11~ 0.16	4700	0.11~ 0.16	7400	0.11~ 0.16	1050	0.06~ 0.11
8	4800	0.13~ 0.19	4800	0.13~ 0.19	2800	0.13~ 0.19	2000	0.08~ 0.16	4800	0.13~ 0.19	3600	0.13~ 0.19	5600	0.13~ 0.19	800	0.08~ 0.14
10	3800	0.14~ 0.22	3800	0.14~ 0.22	2200	0.14~ 0.22	1600	0.10~ 0.18	3800	0.14~ 0.22	2800	0.14~ 0.22	4500	0.14~ 0.22	600	0.10~ 0.16
12	3200	0.16~ 0.24	3200	0.16~ 0.24	1900	0.16~ 0.24	1300	0.12~ 0.20	3200	0.16~ 0.24	2400	0.16~ 0.24	3700	0.16~ 0.24	500	0.12~ 0.18
14	2700	0.18~ 0.28	2700	0.18~ 0.28	1600	0.18~ 0.28	1100	0.13~ 0.22	2700	0.18~ 0.28	2100	0.18~ 0.28	3200	0.18~ 0.28	450	0.13~ 0.20
16	2400	0.20~ 0.29	2400	0.20~ 0.29	1400	0.20~ 0.29	1000	0.14~ 0.25	2400	0.20~ 0.29	1800	0.20~ 0.29	2800	0.20~ 0.29	400	0.14~ 0.23
18	2100	0.24~ 0.32	2100	0.24~ 0.32	1200	0.24~ 0.32	880	0.15~ 0.28	2100	0.24~ 0.32	1600	0.24~ 0.32	2500	0.24~ 0.32	350	0.15~ 0.25

1. When the tool is used for the first time, please make a test cutting with 90% of cutting speed or 85% feed rate mentioned above. If the cutting conditions remain stable, gradually increase the cutting speed and feed rate.
2. The cutting conditions above are for drilling with emulsion.
3. Use a collet without any defect or dust. The radial run-out of drill must be under 0.02mm.
4. These conditions above are for cutting depth under 8D.

1. Beim ersten Einsatz 90% der empfohlenen Schnittgeschwindigkeit oder 85% des Vorschubes wählen. Bei stabiler Bearbeitung die Schnittdaten entsprechend erhöhen.
2. Die obigen Schnittdatenempfehlungen basieren auf dem Einsatz von Emulsion.
3. Keine defekte Werkzeugaufnahme wählen. Die Rundlaufgenauigkeit muss unter 0,02mm liegen.
4. Die obigen Schnittdaten sind für Bohrungstiefen unter 8xD ausgelegt.

C

Solid carbide drills
Vollhartmetallbohrer

SU series step drills · SU Stufenbohrer Serie (External coolant / Externe Kühlung)

3D

workpiece material Werkstückstoff	Mild steel Baustahl HB≤180		Carbon steel, alloy steel Kohlenstoffstahl Leg. Stahl ~30HRC		Pre-hardened steel Vergüteter Stahl ~40HRC		Stainless steel Rostfreier Stahl		Cast iron Gusseisen		Nodular cast iron GGG Kugelgraphitguss		Aluminum alloy Alulegierungen		Heat resistant alloy Warmfeste Legierungen	
Vc	50~100m/min		50~100m/min		30~50m/min		25~40m/min		50~100m/min		40~80m/min		60~120m/min		15~25m/min	
Ø (mm)	n (min ⁻¹)	f (mm/r)	n (min ⁻¹)	f (mm/r)	n (min ⁻¹)	f (mm/r)	n (min ⁻¹)	f (mm/r)	n (min ⁻¹)	f (mm/r)	n (min ⁻¹)	f (mm/r)	n (min ⁻¹)	f (mm/r)	n (min ⁻¹)	f (mm/r)
3.3	5800	0.09~0.12	5800	0.09~0.12	3850	0.09~0.12	2900	0.03~0.07	5800	0.09~0.12	5000	0.09~0.12	10000	0.09~0.12	1600	0.03~0.06
4.2	4550	0.10~0.15	4550	0.10~0.15	3000	0.10~0.15	2300	0.04~0.08	4550	0.10~0.15	3800	0.10~0.15	7600	0.10~0.15	1250	0.04~0.07
5	3800	0.12~0.18	3800	0.12~0.18	2550	0.12~0.18	1900	0.05~0.10	3800	0.12~0.18	3200	0.12~0.18	6400	0.12~0.18	1050	0.05~0.10
6.75	2850	0.14~0.20	2850	0.14~0.20	1900	0.14~0.20	1400	0.06~0.12	2850	0.14~0.20	2400	0.14~0.20	4800	0.14~0.20	800	0.06~0.11
7	2750	0.15~0.22	2750	0.15~0.22	1800	0.15~0.22	1350	0.07~0.14	2750	0.15~0.22	2300	0.15~0.22	4550	0.15~0.22	730	0.07~0.12
8.5	2250	0.16~0.24	2250	0.16~0.24	1500	0.16~0.24	1100	0.08~0.16	2250	0.16~0.24	1800	0.16~0.24	3600	0.16~0.24	600	0.08~0.14
9	2100	0.17~0.25	2100	0.17~0.25	1400	0.17~0.25	1050	0.09~0.17	2100	0.17~0.25	1750	0.17~0.25	3500	0.17~0.25	560	0.09~0.15
10.25	1850	0.18~0.27	1850	0.18~0.27	1250	0.18~0.27	930	0.10~0.18	1850	0.18~0.27	1550	0.18~0.27	3100	0.18~0.27	500	0.10~0.16
10.5	1800	0.19~0.28	1800	0.19~0.28	1200	0.19~0.28	900	0.11~0.19	1800	0.19~0.28	1500	0.19~0.28	3000	0.19~0.28	480	0.11~0.17
12	1600	0.20~0.30	1600	0.20~0.30	1050	0.20~0.30	800	0.12~0.20	1600	0.20~0.30	1300	0.20~0.30	2600	0.20~0.30	450	0.12~0.18
12.5	1550	0.20~0.30	1550	0.20~0.30	1000	0.20~0.30	760	0.12~0.20	1550	0.20~0.30	1250	0.20~0.30	2550	0.20~0.30	410	0.12~0.18
14	1350	0.22~0.35	1350	0.22~0.35	900	0.22~0.35	700	0.14~0.24	1350	0.22~0.35	1150	0.22~0.35	2300	0.22~0.35	370	0.13~0.20
14.5	1300	0.22~0.35	1300	0.22~0.35	880	0.22~0.35	650	0.14~0.24	1300	0.22~0.35	1050	0.22~0.35	2200	0.22~0.35	350	0.13~0.20

1. When the tool is used for the first time, please make a test cutting with 90% of cutting speed or 85% feed rate mentioned above. If the cutting conditions remain stable, gradually increase the cutting speed and feed rate.
2. The cutting conditions above are for drilling with emulsion.
3. Use a collet without any defect or dust. The radial run-out of drill must be under 0.02mm.

1. Beim ersten Einsatz 90% der empfohlenen Schnittgeschwindigkeit oder 85% des Vorschubes wählen. Bei stabiler Bearbeitung die Schnittdaten entsprechend erhöhen.
2. Die obigen Schnittdatenempfehlungen basieren auf dem Einsatz von Emulsion.
3. Keine defekte Werkzeugaufnahme wählen. Die Rundlaufgenauigkeit muss unten 0,02mm liegen.



Drilling · Bohren

Recommended cutting data · Schnittdatenempfehlung

SL series twist deep drills · SL Spiraltiefbohrer Serie (Internal coolant · Interne Kühlung)

10D 12D 15D

Workpiece material Werkstückstoff	Mild steel Baustahl HB≤180		Carbon steel, alloy steel Kohlenstoffstahl Leg. Stahl ~30HRC		Pre-hardened steel Vergüteter Stahl ~40HRC		Stainless steel Rostfreier Stahl		Cast iron Gusseisen		Nodular cast iron GGG Kugelgraphitguss		Aluminum alloy Alulegierungen		Heat resistant alloy Warmfeste Legierungen	
	Vc	60~120m/min		60~120m/min		50~80 m/min		40~60 m/min		80~150 m/min		60~120 m/min		100~180 m/min		10~20 m/min
Ø (mm)	n (min ⁻¹)	f (mm/r)	n (min ⁻¹)	f (mm/r)	n (min ⁻¹)	f (mm/r)	n (min ⁻¹)	f (mm/r)	n (min ⁻¹)	f (mm/r)	n (min ⁻¹)	f (mm/r)	n (min ⁻¹)	f (mm/r)	n (min ⁻¹)	f (mm/r)
3	10600	0.06~0.1	10600	0.06~0.1	7400	0.06~0.1	5300	0.03~0.07	12700	0.06~0.1	9500	0.06~0.1	15000	0.09~0.12	2100	0.03~0.06
4	8000	0.08~0.12	8000	0.08~0.12	5600	0.08~0.12	4000	0.04~0.08	96000	0.08~0.12	7000	0.08~0.12	11000	0.10~0.15	1600	0.04~0.07
5	6400	0.10~0.14	6400	0.10~0.14	4500	0.10~0.14	3200	0.05~0.10	7600	0.10~0.14	5700	0.10~0.14	9000	0.10~0.15	1250	0.05~0.9
6	5300	0.11~0.16	5300	0.11~0.16	3700	0.11~0.16	2700	0.06~0.12	6400	0.11~0.16	4700	0.11~0.16	7400	0.11~0.16	1050	0.06~0.11
8	4000	0.13~0.19	4000	0.13~0.19	2800	0.13~0.19	2000	0.08~0.16	4800	0.13~0.19	3600	0.13~0.19	5600	0.13~0.19	800	0.08~0.14
10	3200	0.14~0.22	3200	0.14~0.22	2200	0.14~0.22	1600	0.10~0.18	3800	0.14~0.22	2800	0.14~0.22	4500	0.14~0.22	600	0.10~0.16
12	2700	0.16~0.24	2700	0.16~0.24	1900	0.16~0.24	1300	0.12~0.20	3200	0.16~0.24	2400	0.16~0.24	3700	0.16~0.24	500	0.12~0.18
14	2300	0.18~0.28	2300	0.18~0.28	1600	0.18~0.28	1100	0.13~0.22	2700	0.18~0.28	2100	0.18~0.28	3200	0.18~0.28	450	0.13~0.20
16	2100	0.20~0.30	2100	0.20~0.30	1400	0.20~0.30	1050	0.14~0.25	2100	0.20~0.30	1800	0.20~0.30	2800	0.25~0.36	400	0.14~0.23
18	1800	0.22~0.32	1800	0.22~0.32	1200	0.22~0.32	950	0.15~0.28	1800	0.22~0.32	1600	0.22~0.32	2500	0.28~0.38	350	0.15~0.25
20	1600	0.25~0.35	1600	0.25~0.35	1100	0.25~0.35	800	0.16~0.30	1600	0.25~0.35	1400	0.25~0.35	2300	0.30~0.40	320	0.16~0.28

SL series twist deep drills · SL Spiraltiefbohrer Serie (Internal coolant · Interne Kühlung)

20D 30D

Workpiece material Werkstückstoff	Mild steel Baustahl HB≤180		Carbon steel, alloy steel Kohlenstoffstahl Leg. Stahl ~30HRC		Pre-hardened steel Vergüteter Stahl ~40HRC		Stainless steel Rostfreier Stahl		Cast iron Gusseisen		Nodular cast iron GGG Kugelgraphitguss		Aluminum alloy Alu. Legierungen		Heat resistant alloy Warmfeste Legierungen	
	Vc	70~90 m/min		50~80 m/min		40~60 m/min		40~60 m/min		50~80 m/min		60~80 m/min		100~180 m/min		8~15 m/min
Ø (mm)	n (min ⁻¹)	f (mm/r)	n (min ⁻¹)	f (mm/r)	n (min ⁻¹)	f (mm/r)	n (min ⁻¹)	f (mm/r)	n (min ⁻¹)	f (mm/r)	n (min ⁻¹)	f (mm/r)	n (min ⁻¹)	f (mm/r)	n (min ⁻¹)	f (mm/r)
3	8250	0.06~0.1	7650	0.06~0.1	5200	0.06~0.1	4750	0.03~0.07	7100	0.06~0.1	7600	0.06~0.1	12750	0.09~0.12	1350	0.03~0.06
4	6250	0.08~0.12	5750	0.08~0.12	3900	0.08~0.12	3600	0.04~0.08	5400	0.08~0.12	5600	0.08~0.12	9350	0.10~0.15	1050	0.04~0.07
5	5000	0.10~0.14	4600	0.10~0.14	3150	0.10~0.14	2900	0.05~0.10	4250	0.10~0.14	4550	0.10~0.14	7650	0.10~0.15	800	0.05~0.9
6	4150	0.11~0.16	3800	0.11~0.16	2600	0.11~0.16	2450	0.06~0.12	3600	0.11~0.16	3750	0.11~0.16	6300	0.11~0.16	700	0.06~0.11
8	3100	0.13~0.19	2900	0.13~0.19	1950	0.13~0.19	1800	0.08~0.16	2700	0.13~0.19	2900	0.13~0.19	4750	0.13~0.19	500	0.08~0.14
10	2500	0.14~0.22	2300	0.14~0.22	1550	0.14~0.22	1450	0.10~0.18	2150	0.14~0.22	2250	0.14~0.22	3850	0.14~0.22	400	0.10~0.16
12	2100	0.16~0.24	1950	0.16~0.24	1350	0.16~0.24	1150	0.12~0.20	1800	0.16~0.24	1900	0.16~0.24	3150	0.16~0.24	350	0.12~0.18
14	1800	0.18~0.28	1650	0.18~0.28	1100	0.18~0.28	1000	0.13~0.22	1500	0.18~0.28	1700	0.18~0.28	2700	0.18~0.28	300	0.13~0.20

1. When the tool is used for the first time, please make a test cutting with 90% of cutting speed or 85% feed rate mentioned above. If the cutting conditions remain stable, gradually increase the cutting speed and feed rate.
2. The cutting conditions above are for drilling with emulsion.
3. Use a collet without any defect or dust. The radial run-out of drill must be under 0.02mm.
4. These conditions above are for cutting depth below 30xD.

1. Beim ersten Einsatz 90% der empfohlenen Schnittgeschwindigkeit oder 85% des Vorschubs wählen. Bei stabiler Bearbeitung die Schnittdaten entsprechend erhöhen.
2. Die obigen Schnittdatenempfehlungen basieren auf dem Einsatz von Emulsion.
3. Keine defekte Werkzeugaufnahme wählen. Die Rundlaufgenauigkeit muss unter 0,02mm liegen.
4. Die obigen Schnittdaten sind für Bohrungstiefen unter 30xD ausgelegt.

SP series pilot drills · SP Pilotbohrer Serie (Internal coolant · Interne Kühlung)

3D

Workpiece material Werkstückstoff	Mild steel Baustahl HB≤180		Carbon steel, alloy steel Kohlenstoffstahl Leg. Stahl ~30HRC		Pre-hardened steel Vergüteter Stahl ~40HRC		Stainless steel/ Rostfreier Stahl		Cast iron/ Gusseisen		Nodular cast iron GGG Kugelgrahitguss		Aluminum alloy/ Alulegierungen		Heat resistant alloy Warmfeste Legierungen	
Vc	80~150m/min		80~150m/min		50~80m/min		50~80m/min		80~150m/min		60~120m/min		100~180m/min		15~25m/min	
Ø (mm)	n (min ⁻¹)	f (mm/r)	n (min ⁻¹)	f (mm/r)	n (min ⁻¹)	f (mm/r)	n (min ⁻¹)	f (mm/r)	n (min ⁻¹)	f (mm/r)	n (min ⁻¹)	f (mm/r)	n (min ⁻¹)	f (mm/r)	n (min ⁻¹)	f (mm/r)
3	12700	0.09~ 0.12	12700	0.09~ 0.12	7400	0.09~ 0.12	6300	0.03~ 0.07	12700	0.09~ 0.12	9500	0.09~ 0.12	15000	0.09~ 0.12	2100	0.03~ 0.06
4	9600	0.10~ 0.15	9600	0.10~ 0.15	5600	0.10~ 0.15	4700	0.04~ 0.08	9600	0.10~ 0.15	7000	0.10~ 0.15	11100	0.10~ 0.15	1600	0.04~ 0.07
5	7600	0.12~ 0.18	7600	0.12~ 0.18	4500	0.12~ 0.18	3800	0.05~ 0.10	7600	0.12~ 0.18	5700	0.12~ 0.18	9000	0.12~ 0.18	1250	0.05~ 0.09
6	6400	0.14~ 0.20	6400	0.14~ 0.20	3700	0.14~ 0.20	3200	0.06~ 0.12	6400	0.14~ 0.20	4700	0.14~ 0.20	7400	0.14~ 0.20	1050	0.06~ 0.11
8	4800	0.16~ 0.24	4800	0.16~ 0.24	2800	0.16~ 0.24	2400	0.08~ 0.16	4800	0.16~ 0.24	3600	0.16~ 0.24	5600	0.16~ 0.24	800	0.08~ 0.14
10	3800	0.18~ 0.27	3800	0.18~ 0.27	2200	0.18~ 0.27	1900	0.10~ 0.18	3800	0.18~ 0.27	2800	0.18~ 0.27	4500	0.18~ 0.27	600	0.10~ 0.16
12	3200	0.20~ 0.30	3200	0.20~ 0.30	1900	0.20~ 0.30	1600	0.12~ 0.20	3200	0.20~ 0.30	2400	0.20~ 0.30	3700	0.20~ 0.30	500	0.12~ 0.18
14	2700	0.22~ 0.35	2700	0.22~ 0.35	1600	0.22~ 0.35	1350	0.13~ 0.22	2700	0.22~ 0.35	2100	0.22~ 0.35	3200	0.22~ 0.35	450	0.13~ 0.20

1. When the tool is used for the first time, please make a test cutting with 90% of cutting speed or 85% feed rate mentioned above. If the cutting conditions remain stable, gradually increase the cutting speed and feed rate.
2. The cutting conditions above are for drilling with emulsion.
3. Use a collet without any defect or dust. The radial run-out of drill must be under 0.02mm.
4. These conditions above are for cutting depth below 3xD.

1. Beim ersten Einsatz 90% der empfohlenen Schnittgeschwindigkeit oder 85% des Vorschubs wählen. Bei stabiler Bearbeitung die Schnittdaten entsprechend erhöhen.
2. Die obigen Schnittdatenempfehlungen basieren auf dem Einsatz von Emulsion.
3. Keine defekte Werkzeugaufnahme wählen. Die Rundlaufgenauigkeit muss unter 0,02mm liegen.
4. Die obigen Schnittdaten sind für Bohrungstiefen unter 3xD ausgelegt.

C

 Solid carbide drills
Vollhartmetallbohrer

SL series · SL Serie

Recommended cutting data · Schnittdatenempfehlung (Deep drill · Tiefbohrer)

1 Preparation pilot hole with 1534SP03C*

Herstellung der Pilotbohrung mit 1534SP03C*

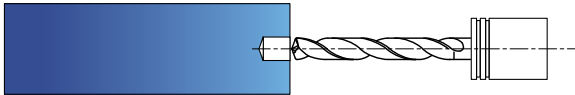

- Top angle of pilot drill must be bigger than SL-drill.
Spitzenwinkel des Pilotbohrers muß größer sein als beim SL-Bohrer.
- Diameter of pilot drill must be 0.01~0.04mm bigger than SL-drill.
Der Durchmesser des Pilotbohrers sollte 0.01~0.04 mm größer sein als beim SL-Bohrer.
- The pilot hole should be $1\sim 3\times D$.
Tiefe der Pilotbohrung soll $1\sim 3\times D$ betragen.
- V_c : 60-80 m/min; f : 0.1-0.25 mm/r; a_p : $1\sim 3\times D$

2 Entering into pilot hole with SL-drill

Einführen des SL-Bohrers in die Pilotbohrung

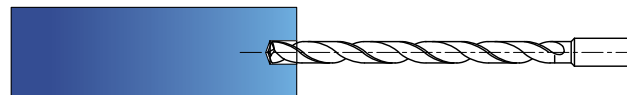

- Entering the pilot hole with low cutting speed. (V_c : 20~30 m/min)
Den SL-Bohrer mit geringer Drehzahl in die Pilotbohrung einführen. (V_c : 20~30 m/min)
- 1~3 mm stop before end of pilot hole. ($V_f=0$)
1~3 mm vor dem Lochende stehenbleiben. ($V_f=0$)
- Increase cutting speed up to recommended parameter and then start feed rate.
Die Schnittgeschwindigkeit auf die empfohlenen Parameter erhöhen und erst dann mit dem Vorschub beginnen.

3 Making deep hole

Herstellung der Tieflochbohrung

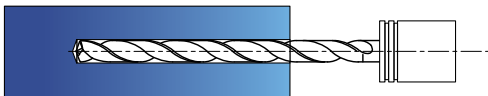

- Drilling with suitable cutting speed and feed rate.
Bohren mit geeigneter Schnittgeschwindigkeit und Vorschüben.
- At cross holes feed rate should be reduced to 0.05 mm/rev..
Bei Querbohrungen den Vorschub auf 0.05 mm/u reduzieren.

4 Pull back of drill

Herausziehen des Bohrers

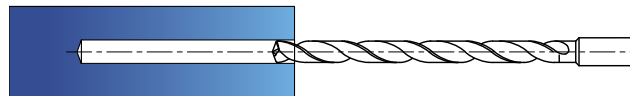

- After reaching the required depth reduce the cutting speed (V_c : 20~30 m/min) and pull back the drill by high feed rate. (V_f : 2000 mm/min)
Nach Erreichen der geforderten Bohrtiefe die Schnittgeschwindigkeit reduzieren (V_c : 20~30 m/min) und den Bohrer mit hohem Vorschub (V_f : 2000 mm/min) herausziehen.

General information · Allgemeiner Hinweis

If surface contour is not flat use suitable operation (e.g. face milling with solid carbide endmill) for preparation.

Sollte die Kontur des Bauteils eine Schräge aufweisen, eine geeignete Bearbeitung (z.B. Planfräsen mit VHM - Fräser) zur Begrädigung durchführen.

ST series twist drills · ST Spiralbohrer Serie (Internal coolant / Interne Kühlung)

3D

5D

Workpiece material Werkstückstoff	Mild steel Baustahl HB≤180		Carbon steel, alloy steel Kohlenstoff - stahl Leg. Stahl ~30HRC		Stainless steel · Rostfreier Stahl					
					Austenite		Martensite		Ferrite	
Vc	80~150m/min		80~150m/min		40~80 m/min		50~100 m/min		60~120 m/min	
Ø (mm)	n (min ⁻¹)	f (mm/r)	n (min ⁻¹)	f (mm/r)	n (min ⁻¹)	f (mm/r)	n (min ⁻¹)	f (mm/r)	n (min ⁻¹)	f (mm/r)
3	12700	0.09~0.12	12700	0.09~0.12	6300	0.03~0.07	7400	0.03~0.07	9000	0.03~0.07
4	9600	0.10~0.15	9600	0.10~0.15	4700	0.04~0.08	5600	0.04~0.08	6700	0.04~0.08
5	7600	0.12~0.18	7600	0.12~0.18	3800	0.05~0.10	4500	0.05~0.10	5400	0.05~0.10
6	6400	0.14~0.20	6400	0.14~0.20	3200	0.06~0.12	3700	0.06~0.12	4500	0.06~0.12
8	4800	0.16~0.24	4800	0.16~0.24	2400	0.08~0.16	2800	0.08~0.16	3400	0.08~0.16
10	3800	0.18~0.27	3800	0.18~0.27	1900	0.10~0.18	2200	0.10~0.18	2700	0.10~0.18
12	3200	0.20~0.30	3200	0.20~0.30	1600	0.12~0.20	1900	0.12~0.20	2300	0.12~0.20
14	2700	0.22~0.35	2700	0.22~0.35	1350	0.13~0.22	1600	0.13~0.22	1900	0.13~0.22
16	2400	0.25~0.36	2400	0.25~0.36	1200	0.14~0.25	1400	0.14~0.25	1700	0.14~0.25
18	2100	0.28~0.38	2100	0.28~0.38	1050	0.15~0.28	1200	0.15~0.28	1500	0.15~0.28
20	1900	0.30~0.40	1900	0.30~0.40	950	0.16~0.30	1100	0.16~0.30	1350	0.16~0.30

1. When the tool is used for the first time, please make a test cutting with 90% of cutting speed or 85% feed rate mentioned above. If the cutting conditions remain stable, gradually increase the cutting speed and feed rate.
2. The cutting conditions above are for drilling with emulsion.
3. Use a collet without any defect or dust. The radial run-out of drill must be under 0.02mm.
4. These conditions above are for cutting depth under 5D.

1. Beim ersten Einsatz 90% der empfohlenen Schnittgeschwindigkeit oder 85% des Vorschubes wählen. Bei stabiler Bearbeitung die Schnittdaten entsprechend erhöhen.
2. Die obigen Schnittdatenempfehlungen basieren auf dem Einsatz von Emulsion.
3. Keine defekte Werkzeugaufnahme wählen. Die Rundlaufgenauigkeit muss unter 0,02mm liegen.
4. Die obigen Schnittdaten sind für Bohrungstiefen unter 5xD ausgelegt.



Drilling · Bohren

Recommended cutting data · Schnittdatenempfehlung

SH series step drills · SH Spiralbohrer Serie (External coolant / Externe Kühlung)

3D

Workpiece material Werkstückstoff	Hardened steel · Gehärteter Stahl					
	40~50HRC		50~55HRC		55~60HRC	
Vc	20~40m/min		15~30m/min		10~20m/min	
Ø (mm)	n (min ⁻¹)	f (mm/r)	n (min ⁻¹)	f (mm/r)	n (min ⁻¹)	f (mm/r)
3	3200	0.02~0.03	2100	0.02~0.03	1060	0.015~0.02
4	2400	0.03~0.04	1600	0.03~0.04	800	0.02~0.025
5	1900	0.04~0.05	1250	0.04~0.05	640	0.025~0.03
6	1600	0.05~0.06	1050	0.05~0.06	530	0.03~0.04
8	1200	0.06~0.08	800	0.06~0.07	400	0.04~0.05
10	950	0.08~0.10	640	0.07~0.08	320	0.05~0.06
12	800	0.10~0.12	530	0.08~0.09	270	0.06~0.07
14	680	0.12~0.14	450	0.09~0.10	230	0.07~0.08
16	600	0.14~0.16	400	0.10~0.12	200	0.08~0.10

1. When the tool is used for the first time, please make a test cutting with 90% of cutting speed or 85% feed rate mentioned above. If the cutting conditions remain stable, gradually increase the cutting speed and feed rate.
2. The cutting conditions above are for drilling with emulsion.
3. Use a collet without any defect or dust. The radial run-out of drill must be under 0.02mm.
4. These conditions above are for cutting depth under 3D.

1. Beim ersten Einsatz 90% der empfohlenen Schnittgeschwindigkeit oder 85% des Vorschubes wählen. Bei stabiler Bearbeitung die Schnittdaten entsprechend erhöhen.
2. Die obigen Schnittdatenempfehlungen basieren auf dem Einsatz von Emulsion.
3. Keine defekte Werkzeugaufnahme wählen. Die Rundlaufgenauigkeit muss unter 0,02mm liegen.
4. Die obigen Schnittdaten sind für Bohrungstiefen unter 3xD ausgelegt.

C

Solid carbide drills
Vollhartmetallbohrer

SC series twist drills · SC Spiralbohrer Serie (External coolant / Externe Kühlung)

3D
5D

Workpiece material Werkstückstoff	Cast iron Grauguss		Nodular cast iron GGG Kugelgraphitguss		Silicon aluminium alloy Silizium Alulegierung				Aluminum alloy Alulegierung	
	Vc		40~70m/min		100~180m/min		80~140m/min		120~200m/min	
Ø (mm)	n (min ⁻¹)	f (mm/r)	n (min ⁻¹)	f (mm/r)	n (min ⁻¹)	f (mm/r)	n (min ⁻¹)	f (mm/r)	n (min ⁻¹)	f (mm/r)
2	9550	0.06~0.08	8000	0.06~0.08	20000	0.07~0.16	18000	0.07~0.16	24000	0.07~0.16
3	6400	0.09~0.12	5300	0.09~0.12	15000	0.09~0.18	12700	0.09~0.18	16000	0.09~0.18
4	4800	0.10~0.15	4000	0.10~0.15	11000	0.10~0.22	9600	0.10~0.22	12000	0.10~0.22
5	3800	0.12~0.18	3200	0.12~0.18	9000	0.12~0.25	7600	0.12~0.25	10000	0.12~0.25
6	3100	0.14~0.20	2700	0.14~0.20	7400	0.14~0.28	6400	0.14~0.28	8500	0.14~0.28
8	2400	0.16~0.24	2000	0.16~0.24	5600	0.18~0.32	4800	0.18~0.32	6400	0.18~0.32
10	1900	0.18~0.27	1600	0.18~0.27	4500	0.22~0.36	3800	0.22~0.36	5000	0.22~0.36
12	1600	0.20~0.30	1300	0.20~0.30	3700	0.25~0.40	3200	0.25~0.40	4200	0.25~0.40
14	1350	0.22~0.35	1150	0.22~0.35	3200	0.27~0.44	2700	0.27~0.44	3600	0.27~0.44
16	1200	0.25~0.36	1000	0.25~0.36	2800	0.32~0.48	2400	0.32~0.48	3200	0.32~0.48

1. When the tool is used for the first time, please make a test cutting with 90% of cutting speed or 85% feed rate mentioned above. If the cutting conditions remain stable, gradually increase the cutting speed and feed rate.
2. The cutting conditions above are for drilling with emulsion.
3. Use a collet without any defect or dust. The radial run-out of drill must be under 0.02mm.
4. These conditions above are for cutting depth under 5D.

1. Beim ersten Einsatz 90% der empfohlenen Schnittgeschwindigkeit oder 85% des Vorschubes wählen. Bei stabiler Bearbeitung die Schnittdaten entsprechend erhöhen.
2. Die obigen Schnittdatenempfehlungen basieren auf dem Einsatz von Emulsion.
3. Keine defekte Werkzeugaufnahme wählen. Die Rundlaufgenauigkeit muss unter 0,02mm liegen.
4. Die obigen Schnittdaten sind für Bohrungstiefen unter 5xD ausgelegt.



Drilling · Bohren

Recommended cutting data · Schnittdatenempfehlung

PA series coated three-lips drills (External coolant)
PA Serie, beschichtete 3-Lippenbohrer (Externe Kühlung)

3D

Workpiece material Werkstückstoff	Cast iron Grauguss		Nodular cast iron GGG Kugelgraphitguss		Silicon aluminium alloy Silizium Alulegierung				Aluminum alloy Alulegierung		Heat resistant alloy Warmfeste Legierung	
					Si≤10%		Si>10%					
Vc	60~120m/min		50~100m/min		100~180m/min		80~140m/min		120~200m/min		20~40m/min	
Ø (mm)	n (min ⁻¹)	f (mm/r)	n (min ⁻¹)	f (mm/r)	n (min ⁻¹)	f (mm/r)	n (min ⁻¹)	f (mm/r)	n (min ⁻¹)	f (mm/r)	n (min ⁻¹)	f (mm/r)
3	9500	0.09~ 0.12	7400	0.09~ 0.12	14000	0.07~ 0.16	12700	0.07~ 0.16	16000	0.07~ 0.16	3200	0.03~ 0.06
4	7000	0.10~ 0.15	5600	0.10~ 0.15	10000	0.09~ 0.18	9600	0.09~ 0.18	12000	0.09~ 0.18	2400	0.04~ 0.07
5	5700	0.12~ 0.18	4500	0.12~ 0.18	9000	0.10~ 0.22	7600	0.10~ 0.22	10000	0.10~ 0.22	1900	0.05~ 0.09
6	4700	0.14~ 0.20	3700	0.14~ 0.20	7400	0.12~ 0.25	6400	0.12~ 0.25	8500	0.12~ 0.25	1600	0.06~ 0.11
8	3600	0.16~ 0.24	2800	0.16~ 0.24	5600	0.14~ 0.28	4800	0.14~ 0.28	6400	0.14~ 0.28	1200	0.08~ 0.14
10	2800	0.18~ 0.27	2200	0.18~ 0.27	4500	0.18~ 0.32	3800	0.18~ 0.32	5000	0.18~ 0.32	950	0.10~ 0.16
12	2400	0.20~ 0.30	1900	0.20~ 0.30	3700	0.22~ 0.36	3200	0.22~ 0.36	4200	0.22~ 0.36	800	0.12~ 0.18
14	2100	0.22~ 0.35	1600	0.22~ 0.35	3200	0.25~ 0.40	2700	0.25~ 0.40	3600	0.25~ 0.40	700	0.13~ 0.20
16	1800	0.25~ 0.36	1400	0.25~ 0.36	2800	0.27~ 0.44	2400	0.27~ 0.44	3200	0.27~ 0.44	600	0.14~ 0.23
18	1600	0.28~ 0.38	1200	0.28~ 0.38	2500	0.32~ 0.48	2100	0.32~ 0.48	2800	0.32~ 0.48	530	0.15~ 0.25
20	1400	0.30~ 0.40	1100	0.30~ 0.40	2300	0.36~ 0.54	1900	0.36~ 0.54	2550	0.36~ 0.54	480	0.16~ 0.28

1. When the tool is used for the first time, please make a test cutting with 90% of cutting speed or 85% feed rate mentioned above. If the cutting conditions remain stable, gradually increase the cutting speed and feed rate.
2. The cutting conditions above are for drilling with emulsion.
3. Use a collet without any defect or dust. The radial run-out of drill must be under 0.02mm.
4. These conditions above are for cutting depth under 3D.

1. Beim ersten Einsatz 90% der empfohlenen Schnittgeschwindigkeit oder 85% des Vorschubes wählen. Bei stabiler Bearbeitung die Schnittdaten entsprechend erhöhen.
2. Die obigen Schnittdatenempfehlungen basieren auf dem Einsatz von Emulsion.
3. Keine defekte Werkzeugaufnahme wählen. Die Rundlaufgenauigkeit muss unter 0,02mm liegen.
4. Die obigen Schnittdaten sind für Bohrungstiefen unter 3xD ausgelegt.

C

Solid carbide drills
Vollhartmetallbohrer

PC series straight flute drills (External coolant)
PC gerade genutete Bohrer Serie (Externe Kühlung)

3D 5D

Workpiece material Werkstückstoff	Cast iron Grauguss		Nodular cast iron GGG Kugelgraphitguss		Silicon aluminium alloy Silizium Alulegierung				Aluminum alloy Alulegierung	
					Si≤10%		Si>10%			
Vc	60~120m/min		50~100m/min		100~200m/min		80~160m/min		120~220m/min	
Ø (mm)	n (min ⁻¹)	f (mm/r)	n (min ⁻¹)	f (mm/r)	n (min ⁻¹)	f (mm/r)	n (min ⁻¹)	f (mm/r)	n (min ⁻¹)	f (mm/r)
4	7000	0.10~0.15	5600	0.10~0.15	11000	0.12~0.20	9600	0.12~0.20	12000	0.12~0.20
5	5700	0.12~0.18	4500	0.12~0.18	9000	0.14~0.26	7600	0.14~0.26	10000	0.14~0.26
6	4700	0.14~0.20	3700	0.14~0.20	7400	0.16~0.28	6400	0.16~0.28	8500	0.16~0.28
8	3600	0.16~0.24	2800	0.16~0.24	5500	0.18~0.30	4800	0.18~0.30	6400	0.18~0.30
10	2800	0.18~0.27	2200	0.18~0.27	4500	0.20~0.32	3800	0.20~0.32	5000	0.20~0.32
12	2400	0.20~0.30	1900	0.20~0.30	3700	0.24~0.36	3200	0.24~0.36	4200	0.24~0.36
14	2100	0.22~0.35	1600	0.22~0.35	3200	0.28~0.44	2700	0.28~0.44	3600	0.28~0.44
16	1800	0.25~0.36	1400	0.25~0.36	2800	0.30~0.48	2400	0.30~0.48	3200	0.30~0.48
18	1600	0.28~0.38	1200	0.28~0.38	2500	0.34~0.52	2100	0.34~0.52	3000	0.34~0.52
20	1400	0.30~0.40	1100	0.30~0.40	2300	0.40~0.63	1900	0.40~0.63	2500	0.40~0.63

1. When the tool is used for the first time, please make a test cutting with 90% of cutting speed or 85% feed rate mentioned above. If the cutting conditions remain stable, gradually increase the cutting speed and feed rate.
2. The cutting conditions above are for drilling with emulsion.
3. Use a collet without any defect or dust. The radial run-out of drill must be under 0.02mm.
4. These conditions above are for cutting depth under 5D.

1. Beim ersten Einsatz 90% der empfohlenen Schnittgeschwindigkeit oder 85% des Vorschubes wählen. Bei stabiler Bearbeitung die Schnittdaten entsprechend erhöhen.
2. Die obigen Schnittdatenempfehlungen basieren auf dem Einsatz von Emulsion.
3. Keine defekte Werkzeugaufnahme wählen. Die Rundlaufgenauigkeit muss unter 0,02mm liegen.
4. Die obigen Schnittdaten sind für Bohrungstiefen unter 5xD ausgelegt.

C

Solid carbide drills
Vollhartmetallbohrer

Drilling - Bohren

Recommended cutting data - Schnittdatenempfehlung

PC series straight flute drills (Internal coolant)
PC Bohrer Serie, gerade genutete (Interne Kühlung)

15D

Workpiece material Werkstückstoff	Cast iron Grauguss		Nodular cast iron GGG Kugelgraphitguss		Silicon aluminium alloy Silizium Alulegierung.				Aluminum alloy Alulegierung	
					Si≤10%		Si>10%			
Vc	60~120m/min		50~100m/min		100~200m/min		80~160m/min		120~220m/min	
Ø (mm)	n (min ⁻¹)	f (mm/r)	n (min ⁻¹)	f (mm/r)	n (min ⁻¹)	f (mm/r)	n (min ⁻¹)	f (mm/r)	n (min ⁻¹)	f (mm/r)
5	5700	0.08~0.14	4500	0.08~0.14	9000	0.09~0.18	7600	0.09~0.18	10000	0.09~0.18
6	4700	0.10~0.16	3700	0.10~0.16	7400	0.12~0.20	6400	0.12~0.20	8500	0.12~0.20
8	3600	0.12~0.20	2800	0.12~0.20	5500	0.12~0.24	4800	0.12~0.24	6400	0.12~0.24
10	2800	0.14~0.23	2200	0.14~0.23	4500	0.16~0.28	3800	0.16~0.28	5000	0.16~0.28
12	2400	0.16~0.26	1900	0.16~0.26	3700	0.18~0.32	3200	0.18~0.32	4200	0.18~0.32
14	2100	0.18~0.32	1600	0.18~0.32	3200	0.20~0.36	2700	0.20~0.36	3600	0.20~0.36

1. When the tool is used for the first time, please make a test cutting with 90% of cutting speed or 85% feed rate mentioned above. If the cutting conditions remain stable, gradually increase the cutting speed and feed rate.
2. The cutting conditions above are for drilling with emulsion.
3. Use a collet without any defect or dust. The radial run-out of drill must be under 0.02mm.
4. These conditions above are for cutting depth under 15D.

1. Beim ersten Einsatz 90% der empfohlenen Schnittgeschwindigkeit oder 85% des Vorschubes wählen. Bei stabiler Bearbeitung die Schnittdaten entsprechend erhöhen.
2. Die obigen Schnittdatenempfehlungen basieren auf dem Einsatz von Emulsion.
3. Keine defekte Werkzeugaufnahme wählen. Die Rundlaufgenauigkeit muss unter 0,02mm liegen.
4. Die obigen Schnittdaten sind für Bohrungstiefen unter 15xD ausgelegt.

C

Solid carbide drills
Vollhartmetallbohrer

SC series centering drill · SC Serie Zentrierbohrer (External coolant / Externe Kühlung)

CENTER LOCATING · ZENTRIERBOHREN

Workpiece material Werkstückstoff	Cast iron Grauguss		Nodular cast iron GGG Kugelgraphitguss		Silicon aluminium alloy Silizium Alulegierung				Aluminum alloy Alulegierung	
					Si≤10%		Si>10%			
Vc	60~120m/min		50~100m/min		100~180m/min		80~140m/min		120~200m/min	
Ø (mm)	n (min ⁻¹)	f (mm/r)	n (min ⁻¹)	f (mm/r)	n (min ⁻¹)	f (mm/r)	n (min ⁻¹)	f (mm/r)	n (min ⁻¹)	f (mm/r)
5	6400	0.09~0.14	5100	0.09~0.14	9000	0.12~0.25	7600	0.12~0.25	10000	0.12~0.25
6	5300	0.12~0.16	4200	0.12~0.16	7400	0.14~0.28	6400	0.14~0.28	8500	0.14~0.28
8	4000	0.13~0.20	3200	0.13~0.20	5600	0.18~0.32	4800	0.18~0.32	6400	0.18~0.32
10	3200	0.17~0.25	2500	0.17~0.25	4500	0.22~0.36	3800	0.22~0.36	5000	0.22~0.36
12	2700	0.20~0.30	2100	0.20~0.30	3700	0.25~0.40	3200	0.25~0.40	4200	0.25~0.40
14	2400	0.22~0.32	1800	0.22~0.32	3200	0.27~0.44	2700	0.27~0.44	3600	0.27~0.44
16	2000	0.24~0.34	1600	0.24~0.34	2800	0.32~0.48	2400	0.32~0.48	3200	0.32~0.48
20	1600	0.28~0.40	1300	0.28~0.40	2300	0.40~0.60	1900	0.40~0.60	2550	0.40~0.60

1. The cutting conditions above are applicable for center drilling.
2. When the tool is used for the first time, please make a test cutting with 90% of cutting speed or 85% feed rate mentioned above. If the cutting conditions remain stable, gradually increase the cutting speed and feed rate.
3. The cutting conditions above are for drilling with emulsion.
4. Please reduce the feed speed when center drilling at inclined and curved face.
5. Use a collet without any defect or dust. The radial run-out of drill must be under 0.02mm.

1. Obige Schnittdatenempfehlungen gelten für das Zentrierbohren.
2. Beim ersten Einsatz 90% der empfohlenen Schnittgeschwindigkeit oder 85% des Vorschubes wählen. Bei stabiler Bearbeitung die Schnittdaten entsprechend erhöhen.
3. Die obigen Schnittdatenempfehlungen basieren auf dem Einsatz von Emulsion.
4. Beim Bohren in sehr großen schrägen und ungeraden Flächen, Schnittdaten reduzieren.
5. Keine defekte Werkzeugaufnahme wählen. Die Rundlaufgenauigkeit muss unten 0,02mm liegen.

CHAMFERING · FASEN

Workpiece material Werkstückstoff	Cast iron Gusseisen		Nodular cast iron GGG Kugelgraphitguss		Silicon aluminium alloy Silizium Alulegierung				Aluminum alloy Alulegierung	
					Si≤10%		Si>10%			
Vc	90~180m/min		70~150m/min		150~270m/min		120~210m/min		180~300m/min	
Ø (mm)	n (min ⁻¹)	f (mm/r)	n (min ⁻¹)	f (mm/r)	n (min ⁻¹)	f (mm/r)	n (min ⁻¹)	f (mm/r)	n (min ⁻¹)	f (mm/r)
5	9600	0.09~0.20	7600	0.09~0.20	13500	0.12~0.30	11500	0.12~0.30	15000	0.12~0.30
6	8000	0.12~0.22	6400	0.12~0.22	11100	0.14~0.34	9600	0.14~0.34	12700	0.14~0.34
8	6000	0.13~0.28	4800	0.13~0.28	8400	0.18~0.40	7200	0.18~0.40	9600	0.18~0.40
10	4800	0.17~0.32	3800	0.17~0.32	6800	0.22~0.44	5700	0.22~0.44	7600	0.22~0.44
12	4000	0.20~0.38	3200	0.20~0.38	5600	0.25~0.50	4800	0.25~0.50	6400	0.25~0.50
14	3600	0.22~0.42	2700	0.22~0.42	4800	0.27~0.56	4000	0.27~0.56	5400	0.27~0.56
16	3000	0.24~0.46	2400	0.24~0.46	4200	0.32~0.60	3600	0.32~0.60	4800	0.32~0.60
20	2400	0.28~0.58	1900	0.28~0.58	3500	0.40~0.76	2850	0.40~0.76	3800	0.40~0.76

1. When the tool is used for the first time, please make a test cutting with 90% of cutting speed or 85% feed rate mentioned above. If the cutting conditions remain stable, gradually increase the cutting speed and feed rate.
2. The cutting conditions above are applicable for chamfer drilling.
3. The cutting conditions above are for drilling with emulsion.
4. Use a collet without any defect or dust. The radial run-out of drill must be under 0.02mm.

1. Beim ersten Einsatz 90% der empfohlenen Schnittgeschwindigkeit oder 85% des Vorschubes wählen. Bei stabiler Bearbeitung die Schnittdaten entsprechend erhöhen.
2. Obige Schnittdatenempfehlungen gelten für das Fasen.
3. Die obigen Schnittdatenempfehlung basieren auf dem Einsatz von Emulsion.
4. Keine defekte Werkzeugaufnahme wählen. Die Rundlaufgenauigkeit muss unter 0,02mm liegen.

Application guide of drills - Einsatzhinweise

Drill clamping Bohrer Aufnahme

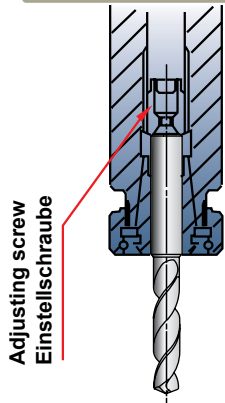

Guarantee tight clamping by using thrust bearing type collet chuck.

Präzisionsspannzangen verwenden.

Max. drill length Max. Bohrtiefe

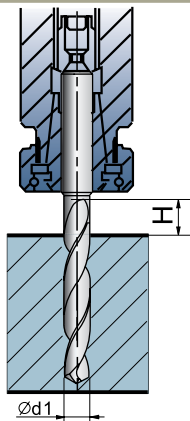

Ensure the size of H is over 1.5d

Abstand H = 1.5d

Radial Run-out Rundlauf toleranz

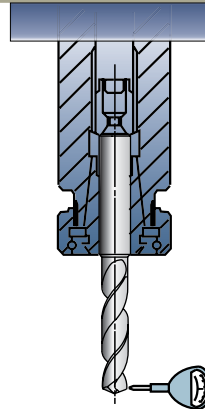

The Radial Run-out should be under 0.02mm.

Rundlaufabweichung < 0,02mm

Wrong drill clamping Ungünstige Bohrer- klemmung

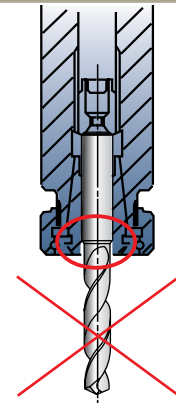

Don't clamp on the drill flutes.

Bitte nicht auf dem Spankanal spannen.

External: coolant method Externe Kühlmittelzufuhr

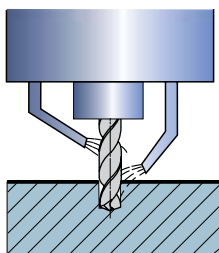

The coolant liquid should shoot to the end and the center of drill as shown in the figure.

Zwei Kühlmittelleitungen sind ideal. (Bohrerspitze und Bohrer, wie in der Abb. oben)

Internal: coolant method Interne Kühlmittelzufuhr

Coolant through spindle

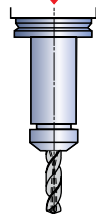

Coolant not through spindle

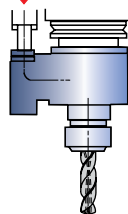

Coolant pressure is about 0.5~1mpa (coolant pressure is 2~3mpa when the diameter is less than Ø5 mm)
Coolant volume is 1.5~4L/min.

Kühlmitteldruck ist ca. 0,5-1 mpa (bei Durchmesser unter 5mm, Kühlmitteldruck auf 2-3 mpa erhöhen)
Kühlmittelmenge: 1,5-4L/min

Cautions to use coolant Handling mit Kühlmitteln

When using Internal Coolant

1. The little chip particles and dust will generate jamming in the oil hole. A fine mesh filter should be used to prevent jamming in the oil hole, especially for the small diameter drills.

2. Dirt and dust particles will adhere to the oil hole and lead to unsmooth coolant flow. Coolant change as early as possible is recommended.

1. Kleine Partikel können die Kühlmittelbohrungen verstopfen. Verwenden Sie daher bitte einen Kühlmittelfilter.

2. Stark verschmutztes Kühlmittel reduziert den Spanfluss. Wir empfehlen ein regelmäßiges Wechseln. Bitte prüfen Sie die einwandfreie Kühlmittelzufuhr.

Interrupted cutting unterbrochene Bearb.

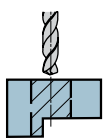

Reduce the feed rate when drilling interrupted cut.

Reduzieren Sie den Vorschub an der unterbrochenen Stelle.

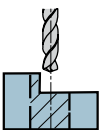

Pre-machining prior drilling
Vorbearbeitung

Machining a countersink with end mill prior to drilling.
Planen Sie die Fläche mit einem Fräser vorab.

Thin workpiece Dünne Werkstücke



Bending occurs
Add a supporter.

Wenn dünne Werkstücke sich verbiegen, verwenden Sie Hilfsmittel.

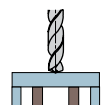

Stepped holes Stufenbohrung

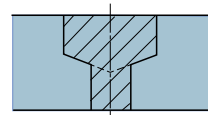

1. Divided to two drilling processes.
2. Drill the larger diameter hole firstly.
3. Multiple step and chamfer drill can be produced by us.

1. Geteilt in 2 Prozesse
2. Bohren Sie das größere Loch zuerst.
3. Auf Anfrage bieten wir auch Stufenbohrer an, die Stufenbohrungen in einem Prozess herstellen können.

burrs and workpiece chippings on Exit Gratbildung oder Ausbrüche beim Austritt des Bohrers

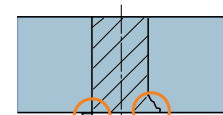

1. Reduce the feed rate at the end time of drilling through
2. Chamfer machined at the exit position.
3. Change the point angle.

1. Reduzieren Sie den Vorschub um ca. die Hälfte beim Austritt.
2. Schleifen Sie eine Fase an den Bohrer.
3. Tauschen Sie den Spitzenwinkel.

Parts terminology of drill · Terminologie von VHM Bohrern

● Version · Ausführung

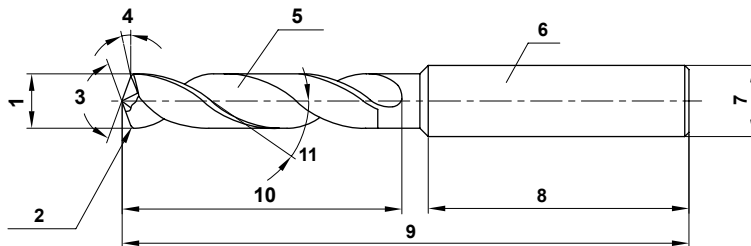

- | | |
|----------------------|----------------------|
| 1. Drilling diameter | 1. Bohrdurchmesser |
| 2. Chamfer | 2. Fase |
| 3. Point angle | 3. Spitzenwinkel |
| 4. Clearance angle | 4. Freiwinkel |
| 5. Chip pocket | 5. Spanraum |
| 6. Shank | 6. Schaft |
| 7. Shank diameter | 7. Schaftdurchmesser |
| 8. Shank length | 8. Schaftlänge |
| 9. Overall length | 9. Gesamtlänge |
| 10. Flute length | 10. Schneidenlänge |
| 11. Helical angle | 11. Spiralwinkel |

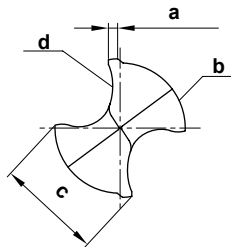

- | | |
|-------------------------|-----------------------|
| a. Margin width | a. Fasenbreite |
| b. Body clearance | b. Körper Freischliff |
| c. Land width | c. Primärfasenbreite |
| d. Primary cutting edge | d. Hauptschneide |

● Cutting edge shapes · Schneidkanten- Ausführung

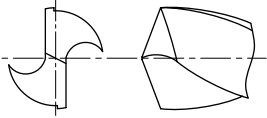
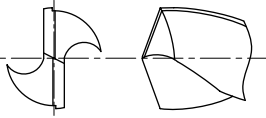
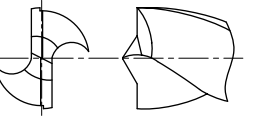
Shape Schneidkanten- ausführung	(Conical · konisch)	(Dual flats · flach)	(Candler · Zentrierspitze)
			
Features Merkmale <ul style="list-style-type: none"> The flank face is conical and the clearance angle increases toward the center of drill. Wide applications, commonly used both for soft and hard materials. Die Flanke ist konisch und der Freiwinkel vergrößert sich zur Bohrermitte. Gebräuchliche Form für weiche und harte Materialien. 	<ul style="list-style-type: none"> The flank face is dual flats, to facilitate cutting and initial entering. Often used for small diameter drills Flache Flanke für leichte Zerspanung. Diese Form ist geeignet für Bohrer mit kleinen Durchmessern. 	<ul style="list-style-type: none"> This shape has two-stage point angle and perfect centering capability, less burs generate when drilling hole. It is the first choice for drilling thin plate. Diese Form hat 2 Winkelpunkte, für bessere Zentrierung und Reduzierung der Gratbildung. Geeignet für Stahlrahmen- und Blechbearbeitung. 	



Drilling - Bohren

Technical Information - Technische Information

Structure specification and cutting characteristics - Bohrspezifikation und Schnittwerte

Chip pocket Spanraum	The function of chip pocket is to remove the chips out of the hole. The larger the cross-sectional area is, the chips is easier to remove out. Durch den Spanraum werden die Späne während der Bearbeitung aus der Bohrung geleitet.
Helical angle Spiralwinkel	The helical angle is the inclined angle of flute at the axial direction of a drill. It varies according to the different position of cutting edge. It decreases greatly as the periphery toward the center. Der Spiralwinkel beschreibt die Steigung der Spiralnute. Er wird entsprechend dem zu bearbeitenden Material ausgelegt. High hardness material Small ← Helical angle → Large soft material Hochvergütetes Material klein ← Spiralwinkel → groß weiches Material
Flute length Schneidenlänge bzw. Spirallänge	It is determined by depth of hole, guide bush length and regrinding allowance. The longer the flute is, the worse the drill rigidity is. Since it greatly influences on the tool life, please minimize it as much as possible when other requirements are met. The minimal flute length generally is hole depth plus the 1.5 times of hole diameter. Die Schneidlänge muss die Bohrungstiefe, die Führungsbuchsenlänge und die Gesamtnachsleiflänge berücksichtigen. Je länger der Spiralwinkel, desto geringer die Bohrerstabilität. Da hierdurch die Standzeit stark beeinflusst wird, sollte er so kurz wie möglich gewählt werden. Die empfohlene minimale Spirallänge: sollte Bohrungstiefe +1,5 x Durchmesser.
Point angle Spitzenwinkel	Generally the angle is 140°, it is set differently as per various applications. Der Spitzenwinkel beträgt normalerweise 140°, er kann jedoch je nach Anwendung unterschiedlich sein. Soft material easy to cut Small ← Point angle → Large for hard materials and high-efficiency machining Weiches Material, einfach zu bearbeiten klein ← Spitzenwinkel → groß gehärtetes Material und Hochleistungsbohren
Hole Kerndurchmesser	It is an important factor that influence, the rigidity and chip control of a drill. It is set according to applications. Low axial cutting force } thin ← hole → thick } Large axial cutting force Low rigidity } } High rigidity Materials easy to cut } } High hardness materials, cross hole drilling etc. Der Kerndurchmesser ist ein wichtiger Faktor und hat Einfluß auf die Stabilität und Spankontrolle: geringe Axialkraft } klein ← Loch → groß } hohe Axialkraft geringe Stabilität } } hohe Stabilität leicht zu zerspanendes Material } } gehärtetes Material oder Querbohrungen.
Margin Fasenbreite	As a drill guide during drilling process. The margin width need to take the hole friction into consideration. small ← margin width → large Low friction and drill guide ← margin width → high friction and good drill guide Die Fasenbreite beeinflusst die Führung und Friktion des Bohrers während der Bearbeitung. klein ← Fasenbreite → groß niedrige Friktion und Bohrer Führung ← Fasenbreite → hohe Friktion und gute Bohrerführung
Back taper Hinterschliff	To decrease the friction with inside wall of the drilled hole, there is a back taper slightly from tool nose to shank. The degree is usually represented by the quantity decreasing in the diameter per 100 mm flute length. Zur Reduzierung der Reibung während der Bearbeitung wird der Bohrerdurchmesser von der Schneide bis zum Schaft leicht reduziert.
Body clearance Körperfreischliff	It is the part formed on the clearance face after margin, mainly to reduce the friction between inside wall of hole and drill periphery Beschreibt den Bohrer hinter der Fasenbreite. Der Freischliff ist notwendig, um die Reibung des Bohrers während der Bearbeitung zu reduzieren.

C

Solid carbide drills
Vollhartmetallbohrer

Common problems and solutions - Allgemeine Fehlerbehebungen

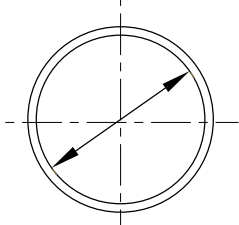
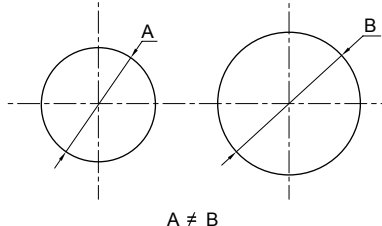
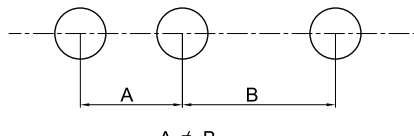
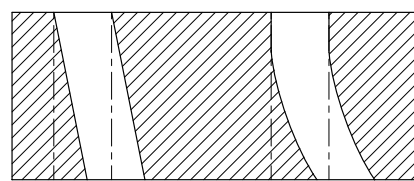
	Problem · Fehler	Cause · Ursache	Solution · Lösung
Hole · Bohrung	<p>Oversize holes Bohrung zu groß</p> 	<p>Poor clamping Large run-out around spindle</p> <p>Ungenügende Werkstück bzw. Werkzeug - Klemmung. großer Rundlauffehler Querschneide ist aus der Mitte</p>	<p>Select a holder and chuck with high precision Calibrating spindle Check and adjust after clamping drill</p> <p>Präzisions-Klemmung verwenden. Spindelspiel reduzieren. Bohrer im geklemmten Zustand prüfen und justieren.</p>
		<p>Non-symmetric point angle Large run-out Chisel edge is off center</p> <p>Kein symetrischer Spitzenwinkel, großer Rundlauffehler Querschneide ist aus der Mitte</p>	<p>Regrind drill Check the precision after regrinding</p> <p>Bohrer nachschleifen, Nachschliff prüfen</p>
	<p>Irregular hole size Ungleichmäßige Bohrungsmaße</p>  <p>A ≠ B</p>	<p>Non-symmetric point angle Large run-out Chisel edge is off center Excessive margin wear</p> <p>Kein symetrischer Spitzenwinkel, großer Rundlauffehler Querschneide ist aus der Mitte Hoher Verschleiß</p>	<p>Select the holder and chuck with high precision Calibrating the spindle Check and adjust after clamping drill</p> <p>Präzisions-Klemmung verwenden. Spindelspiel reduzieren. Bohrer im geklemmten Zustand prüfen und justieren.</p>
		<p>Poor clamping Large spindle run-out Workpiece is unfirmly hold</p> <p>Ungenügende Werkstück/Werkzeug-Klemmung. großer Rundlauffehler Querschneide ist aus der Mitte Hoher Verschleiß</p>	<p>Select the holder and chuck with high precision Calibrating spindle Check and adjust after clamping drill</p> <p>Präzisions-Klemmung verwenden. Spindelspiel reduzieren. Bohrer im geklemmten Zustand prüfen und justieren.</p>
		<p>Feed rate is too high Vorschub zu hoch</p>	<p>Reduce the feed speed Vorschub reduzieren</p>
	<p>Low position accuracy schlechte Bohrer - Positionierung</p>  <p>A ≠ B</p>	<p>Poor re-positioning precision of spindle. Poor clamping Large run-out with spindle</p> <p>Unzureichende Klemmung sowie Spindel Positionierung. Großer Rundlaufabweichung der Spindel.</p>	<p>Improve the re-positioning precision of machine Select the holder and chuck with high precision Calibrating the spindle Check and adjust after clamping drill</p> <p>Positionierung der Maschine verbessern Präzisions-Klemmung verwenden. Spindel kalibrieren, Bohrer im geklemmten Zustand prüfen und justieren.</p>
		<p>The feed direction is not vertical to the workpiece surface Die Vorschubrichtung ist nicht vertikal zur Werkstückfläche</p>	<p>Adjust the feed direction vertical to the workpiece. Vorschubrichtung vertikal zur Werkstückoberfläche einstellen.</p>
		<p>Top center not align with the spindle center (lathe) Werkzeugmitte nicht auf Spindelmitte ausgerichtet (Drehmaschine)</p>	<p>Check and adjust alignment carefully before drilling Werkzeugmitte ausrichten</p>
	<p>Bad linearity Bad perpendicularity Schlechter Bohrungsverlauf</p> 	<p>Excessive tool wear hoher Werkzeugverschleiß</p>	<p>Regrind Nachschleifen</p>
		<p>Poor center hole accuracy schlechte Bohrungsgenauigkeit</p>	<p>Increase the position accuracy of hole Bohrungspositionierung verbessern</p>
		<p>Non-symmetric point angle Large run-out Chisel edge is off center</p> <p>Kein symetrischer Spitzenwinkel, großer Rundlauffehler Querschneide ist aus der Mitte</p>	<p>Regrind drill Check the precision after regrinding Bohrer nachschleifen, Nachschliff prüfen</p>
		<p>Insufficient drill rigidity Unzureichende Bohrerstabilität</p>	<p>Increase drill rigidity Bohrerstabilität verbessern</p>
	<p>Uneven workpiece surface Top center ders not align with the spindle center (lathe) Unebene Werkstückoberfläche Werkzeugmitte nicht auf Spindelmitte ausgerichtet (Drehmaschinen)</p>	<p>The workpiece must be horizontal or pre-machined to horizontal before drilling Pre-drill a center hole</p> <p>Das Werkstück muss vor dem Bohren horizontal ausgerichtet bzw. vorbearbeitet werden.</p>	

Common problems and solutions · Allgemeine Fehlerbehebungen

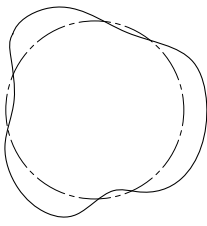
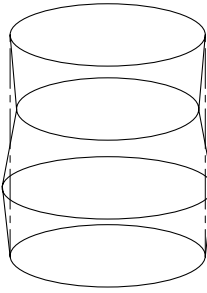
	Problem · Fehler	Cause · Ursache	Solution · Lösung
Hole Bohrung	<p>Poor roundness Ungenau Bohrung (Rundheit)</p> 	Non-symmetric point angle Large drill run-out Chisel edge is off center Kein symetrischer Spitzenwinkel, großer Rundlauffehler, Zentrumschneide ist aus der Mitte. Hoher Verschleiß.	Regrind drill Check the precision after regrinding Bohrer nachschleifen, Nachschliff prüfen
		Poor clamping Large spindle run-out Workpiece is unfirmly hold Unzureichende Klemmung (Werkstück, Werkzeug). Große Rundlaufabweichung der Spindel	Select the holder and chuck with high precision Calibrating the spindle Check run-out and adjust after clamping drill
		Clearance angle is too large Freiwinkel zu groß	Regrind drill Bohrer nachschleifen
		Insufficient drill rigidity Ungenügende Bohrerstabilität	Increase drill rigidity Bohrerstabilität verbessern
	<p>Poor workpiece surface quality Schlechte Werkstückoberflächenqualität</p>	Incorrect regrinding Schlechter Bohrer Nachschliff	Regrind calibration Nachschliff verbessern
		Insufficient coolant or unsuitable coolant Type Ungenügende Kühlmittelmenge bzw. -Methode	Change coolant supply method, increase coolant volume Select the cutting oil with good lubricating property Kühlmittelzuführungsmethode ändern Kühlmittelmenge erhöhen
		Poor clamping Large spindle run-out Unzureichende Klemmung, großer Spiralrundlauffehler	Select the holder and chuck with high precision Calibrating the spindle Präzisions-Klemmung verwenden. Spindel kalibrieren
		Feed rate is too high Vorschub zu hoch	Decrease the feed rate Vorschub verringern
		Excessive wear on cutting edge Excessive build-up on margin Großer Schneidenschleiß, große Aufbauschneidenbildung	Regrind drill Select a coated drill Bohrer nachschleifen, beschichtete Bohrer verwenden
		Chip jamming Schlechte Spanabfuhr	Select a suitable drill (considering flute geometry , helical angle etc) Change the cutting method (adjust feed rate, use step feed etc) Einen geeigneten Bohrer wählen (mit entsprechender Spannute, Spiralwinkel etc.) Schnittgeschw. anpassen (Vorschub verringern usw.)
	<p>Poor cylindricity Schlechte Zylindrizität</p> 	Non-symmetric point angle Large drill run-out Chisel edge is off center Excessive margin wear Kein symetrischer Spitzenwinkel, großer Rundlauffehler (Bohren) Zentrumschneide ist aus der Mitte großer Schneidenschleiß	Regrind drill Check the precision after regrinding Bohrer nachschleifen, Nachschliff prüfen
		Feed speed is too low Vorschub zu gering	Increase the feed speed Vorschub erhöhen

Common problems and solutions - Allgemeine Fehlerbehebungen

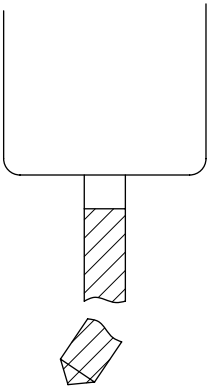
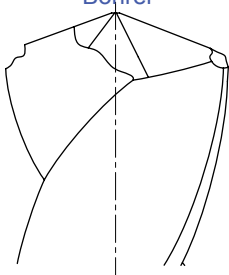
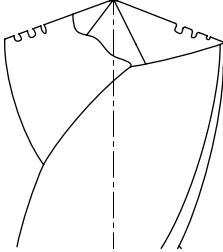
	Problem · Fehler	Cause · Ursache	Solution Lösung
Drill Bohrer	<p>Drill breakage Bruch des Bohrers</p> 	<p>Insufficient clamping of tool and/or workpiece Nicht ausreichende Spannung des Werkzeuges und / oder Werkstücks.</p>	<p>Increase the rigidity of drill, machine, workpiece and clamp Stabilität des Werkzeuges sowie Spannung des Werkzeuges bzw. Werkstücks verbessern</p>
		<p>Clearance angle is too small Freiwinkel zu klein</p>	<p>Use drill with bigger clearance angle or regrind. Bohrer mit größerem Freiwinkel verwenden oder nachschleifen</p>
		<p>Feed rate is too high Vorschub zu hoch</p>	<p>Decrease the feed rate Vorschub verringern</p>
		<p>Excessive drill wear Hoher Verschleiß</p>	<p>Regrind drill Bohrer nachschleifen</p>
		<p>Chip jamming Spänestau</p>	<p>Select a suitable drill (considering flute geometry, helical angle etc) Change the cutting method (adjust feed rate, use step feed etc)</p> <p>Einen geeigneten Bohrer wählen (mit entsprechender Spannute, Spiralwinkel etc.) Schnittgeschw. anpassen (Vorschub verringern, Bohrer lüften usw.)</p>
		<p>Difficult entering the workpiece Schwieriges Anbohren</p>	<p>Increase the rigidity of drill and machine Increase rigidity of workpiece and clamping. Select the drill with a sharp point for easy entry Pre-drill a centre hole. Adjust the level of workpiece or pre-machined to horizontal before drilling. Use guide bush or bush plate Stabilität des Werkzeugs sowie Spannung der Maschine und des Werkstücks verbessern. Bohrer mit scharfer Zentrierschneide. Pilotbohrung setzen. Anbohrwinkel korrigieren oder gerade Fläche fräsen. Einsatz einer Führungsbuchse.</p>
	<p>Chipping on the cutting corner Ausbröcklung am Bohrer</p> 	<p>Hard skin or porous spot Harte Oberfläche oder Lunker</p>	<p>Analyse the workpiece or select a suitable grade Change the cutting parameters (cutting speed, feed rate or machining method) Werkstoff prüfen und entsprechende Sorte auswählen. Schnittbedingungen ändern (Schnittgeschw., Vorschub oder Bearbeitungsmethode)</p>
		<p>Feed rate is too high Vorschub zu hoch</p>	<p>Decrease the feed rate Vorschub verringern</p>
		<p>Insufficient coolant Zu wenig Kühlmittel</p>	<p>Change coolant supply method, increase coolant volume Kühlmittelzufuhr verbessern / erhöhen</p>
	<p>Chipping on cutting edge Ausbröcklung an der Schreide</p> 	<p>Poor clamping Large spindle run-out schlechte Spannung großer Spiralrundlauf</p>	<p>Select the holder and chuck with high precision Calibrating the spindle Spannmittel mit höherer Präzision verwenden. Spindel neu ausrichten.</p>
		<p>Cutting speed and feed rate are too high Decrease the feed rate Schnittgeschwindigkeit und Vorschub zu hoch</p>	<p>Reduce the cutting speed and feed rate. Schnittgeschwindigkeit und Vorschub reduzieren.</p>
		<p>Clearance angle is too large Freiwinkel zu groß</p>	<p>Regrind calibration Bohrer mit kleinerem Freiwinkel verwenden oder nachschleifen</p>

Common problems and solutions · Allgemeine Fehlerbehebungen

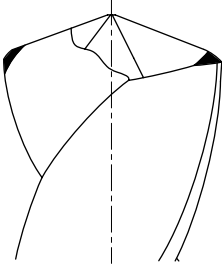
	Problem · Fehler	Cause · Ursache	Solution · Lösung
Drill Bohrer	Abnormal wear on cutting corner Übermäßiger Verschleiß 	Delay to regrind Überfälliger Nachschliff	Regrind in time Frühzeitiger Nachschliff
		Drill point does not align with the spindle center (lathe) Bohrerspizze steht nicht mittig	Check and adjust alignment carefully before drilling Bohrerposition auf Spindelmitte justieren.
		Cutting speed is too high Schnittgeschwindigkeit zu hoch	Reduce cutting speed Schnittgeschwindigkeit reduzieren
		Cutting edge shape is inappropriate Schneidwinkel nicht geeignet	Select correct cutting edge shape Richtigen Schneidwinkel wählen.
		Unsuitable drill material Schneidstoff ungeeignet	Select the suitable drill material Geeigneten Schneidstoff wählen
		Incorrect coolant Type Unzureichende Kühlung	Change coolant Ausreichende Kühlung verwenden
	Wear and chipping on chisel edge Verschleiß und Ausbrüche an Querschneide	Feed rate is too high Vorschub zu hoch	Reduce feed rate Vorschub reduzieren
		Cutting edge shape is inappropriate Schneidwinkel nicht geeignet	Select correct cutting edge shape Richtigen Schneidwinkel wählen.
		Unsuitable drill material Schneidstoff ungeeignet	Select the suitable drill material Geeigneten Schneidstoff wählen.
		Clearance angle is too small Freiwinkel zu gering	Regrind drill Bohrer nachschleifen
	Breakage on margin Bruch der Führungsfase	The size of guide bush or drill bush is too large Führungsbuchse zu groß	Select another bush with correct size Führungsbuchse austauschen
	Margin build-up Aufbauschneide an der Führungsfase	Excessive wear on cutting edge generates high heat Hoher Verschleiß und Hitze	Regrind drill Bohrer nachschleifen
		Insufficient coolant Unzureichende Kühlung	Change coolant supply method, increase coolant volume Kühlmittelzufuhr-Methode ändern
		Incorrect coolant Type falscher Kühlmittelschmierstoff	Change coolant Kühlschmierstoff ändern
		Workpiece material is too soft Ungünstig zu zerspanendes Material	Change drill or machining method Bohrer mit kleineren Freiwinkel wählen
	High vibration Hohe Vibrationen	Clearance angle is too large Freiwinkel zu groß	Regrind drill Bohrer nachschleifen
		Drill rigidity is not enough Bohrerstabilität zu gering	Increase drill rigidity Stabilität verbessern
	Chips roll around the drill Spänewickel	Long chips Chip removal is not fluent Lange Späne, Abfuhr unzureichend	Change the drill and adjust machining method and cutting parameters Schnittdaten optimieren, evt. Bohrer wechseln oder Maschine neu justieren
	One-side wear Einseitiger Verschleiß	Drill point does not align with the spindle center (lathe) Bohrerspizze steht nicht mittig	Check and adjust the alignment carefully before drilling Bohrerposition auf Spindelmitte justieren.
		Poor clamping Schlechte Spannung	Fix drill carefully, control the radial run-out Bohrerklemmung verbessern, Rundlauf kontrollieren.

Twist drill · Spiralbohrer (Non-standard Taylor made · Sonderwerkzeuge)

Name: Company / Firma: Fax: Tel: E-mail:	 Heltorfer Straße 12 40472 Düsseldorf Germany Fax: +49-(0)211-989240-111 E-Mail: info@zccct-europe.com
--	--

Machining information Bearbeitungsinformationen

Size of machined hole Bohrungsdurchmesser	<input type="text"/> mm
Tolerance of machined hole Toleranz der Bohrung	<input type="text"/>
Depth of machined hole Bohrtiefe	<input type="text"/> mm

Selection of twist drill series Spiralbohrerserie

<input type="checkbox"/> SU	<input type="checkbox"/> SH
<input type="checkbox"/> ST	<input type="checkbox"/> SC



Workpiece material · Werkstückstoff

Carbon steel Kohlenstoff-Stahl	Alloy steel Legierter Stahl	Hardened steel · gehärteter Stahl				Stainless steel Rostfreier Stahl	Cast iron, Nodular GGG Grauguss	Copper alloy Kupfer-leg.	Aluminum Alu.	Aluminum alloy Aluleg. Si % =	Titanium alloy Titanleg.	Heat resist. alloy Warmfeste Leg.
		~40HRC	~50HRC	~60HRC	~68HRC							
<input type="checkbox"/>	<input type="checkbox"/>	<input type="checkbox"/>	<input type="checkbox"/>	<input type="checkbox"/>	<input type="checkbox"/>	<input type="checkbox"/>	<input type="checkbox"/>	<input type="checkbox"/>	<input type="checkbox"/>	<input type="checkbox"/>	<input type="checkbox"/>	<input type="checkbox"/>

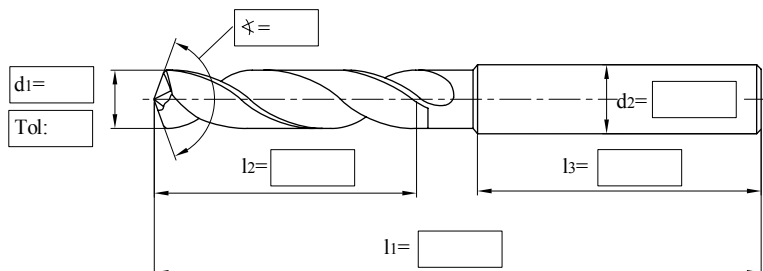
Tool information · Werkzeug Informationen



Shank · Schaft	
DIN6535	<input type="checkbox"/> Form HA
	<input type="checkbox"/> Form HB
	<input type="checkbox"/> Form HE

Cooling / Kühlung	
<input type="checkbox"/> External Extern	
<input type="checkbox"/> Internal Intern	

Coating / Beschichtung	
<input type="checkbox"/> Yes / Ja	
<input type="checkbox"/> No / Nein	

Remarks:
Bemerkungen:

Order quantity: pieces
Auftragsmenge: Stücke

Expected delivery date:
Gewünschtes Lieferdatum:

Date · Datum:

Confirmation · Unterschrift :

Drilling · Bohren

Solid carbide drills · Vollhartmetallbohrer

Step twist drill · Stufenspiralbohrer (Non-standard Taylor made · Sonderwerkzeuge)

Name:	 Heltorfer Straße 12 40472 Düsseldorf Germany Fax: +49-(0)211-989240-111 E-Mail: info@zccct-europe.com
Company / Firma:	
Fax:	
Tel:	
E-mail:	

Machining information Bearbeitungsinformationen

Size of small machined hole Ø Kleine Bohrung	<input type="text"/>	mm
Tolerance of small machined hole Toleranz der kleinen Bohrung	<input type="text"/>	
Size of big machined hole Ø Große Bohrung	<input type="text"/>	mm
Tolerance of big machined hole Toleranz der großen Bohrung	<input type="text"/>	
Depth of machined hole Tiefe der großen Bohrung	<input type="text"/>	mm

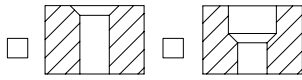

Workpiece material · Werkstückstoff

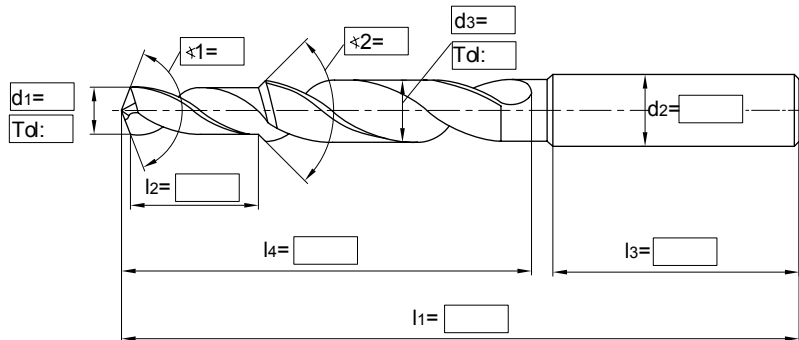

Carbon steel Kohlenstoff-Stahl	Alloy steel Legierter Stahl	Hardened steel · gehärteter Stahl				Stainless steel Rostfreier Stahl	Cast iron, Nodular GGG Grauguss	Copper alloy Kupfer-leg.	Aluminum Alu.	Aluminum alloy Aluleg.	Titanium alloy Titanleg.	Heat resist. alloy Warmfeste Leg.
		~40HRC	~50HRC	~60HRC	~68HRC					Si % =		
<input type="checkbox"/>	<input type="checkbox"/>	<input type="checkbox"/>	<input type="checkbox"/>	<input type="checkbox"/>	<input type="checkbox"/>	<input type="checkbox"/>	<input type="checkbox"/>	<input type="checkbox"/>	<input type="checkbox"/>	<input type="checkbox"/>	<input type="checkbox"/>	

Tool information · Werkzeug Informationen



Shank · Schaft	
<input type="checkbox"/>	Form HA
<input type="checkbox"/>	Form HB
<input type="checkbox"/>	Form HE

DIN6535

Cooling / Kühlung	
<input type="checkbox"/> External Extern	
<input type="checkbox"/> Internal Intern	

Coating / Beschichtung	
<input type="checkbox"/> Yes / Ja	
<input type="checkbox"/> No / Nein	

Remarks:
Bemerkungen:

Order quantity: pieces
Auftragsmenge: Stücke

Expected delivery date:
Gewünschtes Lieferdatum:

Date · Datum:



Confirmation · Unterschrift:

Three lips drill · Drei-Schneiden-Bohrer (Non-standard Taylor made · Sonderwerkzeuge)

Name: Company / Firma: Fax: Tel: E-mail:	 Heltorfer Straße 12 40472 Düsseldorf Germany Fax: +49-(0)211-989240-111 E-Mail: info@zccct-europe.com
--	--

Workpiece material · Werkstückstoff

Carbon steel Kohlenstoff-Stahl	Alloy steel Legierter Stahl	Hardened steel · gehärteter Stahl				Stainless steel Rostfreier Stahl	Cast iron, Nodular GGG Grauguss	Copper alloy Kupfer-leg.	Aluminum Alu.	Aluminum alloy Aluleg.	Titanium alloy Titanleg.	Heat resist. alloy Warmfeste Leg.
		~40HRC	~50HRC	~60HRC	~68HRC					Si % =		

Cooling / Kühlung	
<input type="checkbox"/> External Externe	
<input type="checkbox"/> Internal Interne	

Three lips drill · Drei-Schneiden-Bohrer

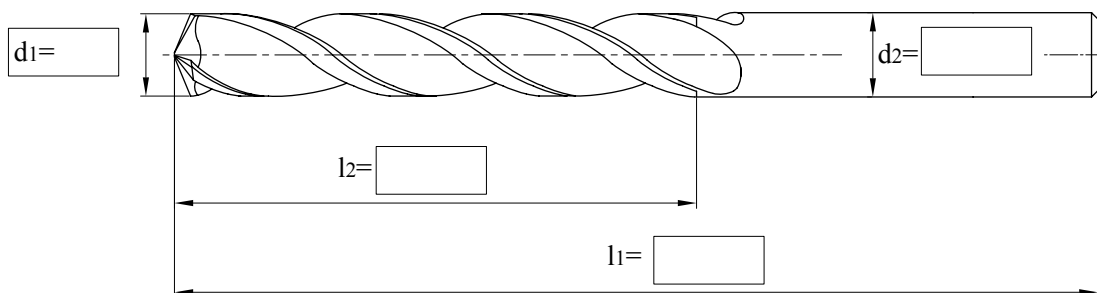

Remarks:
Bemerkungen:

Order quantity: pieces
Auftragsmenge: Stücke

Expected delivery date:
Gewünschtes Lieferdatum:

Date · Datum:

Confirmation · Unterschrift:

Drilling · Bohren

Solid carbide drills · Vollhartmetallbohrer

Straight-flute drill · Gerade genutete Bohrer (Non-standard Taylor made · Sonderwerkzeuge)

Name:

Company / Firma:

Fax:

Tel:

E-mail:



Heltorfer Straße 12
40472 Düsseldorf Germany
Fax: +49-(0)211-989240-111
E-Mail: info@zccct-europe.com

Machining information and Workpiece Material · Bearbeitungsinfo und Werkstückstoff

Size of machined hole Bohrungsdurchmesser	<input type="text"/>	mm
Tolerance of machined hole Toleranz der Bohrung	<input type="text"/>	
Depth of machined hole Bohrtiefe	<input type="text"/>	mm

- Grey cast iron
Grauguss
- Nodular cast iron GGG
Kugelgraphitguss
- Aluminium alloy
Alulegierung
- Si Al alloy Si<10%
Si-Alulegierung
- Si Al alloy Si≥10%
Si-Alulegierung

Machined material trademark
Spezieller Werkstoff

Tensile Strength · Zugfestigkeit

 N/mm²

Hardness · Härte

The straight-flute drill is widely used for cutting short chip materials from cast iron and common Al alloy to high Si Al alloy
 Gerade genutete Bohrer werden weitestgehend für die Bearbeitung von Gusseisen und Aluleg. bis Si-Aluleg. eingesetzt.

Tool information · Werkzeug Informationen

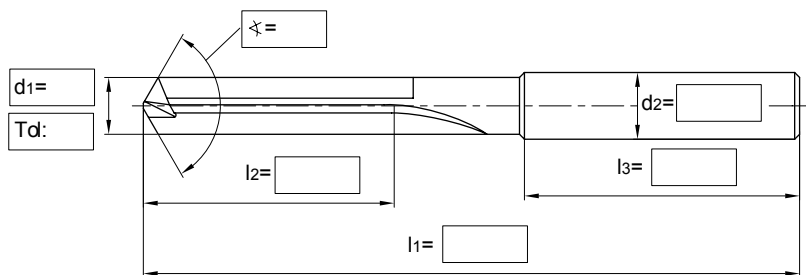

DIN6535	Shank · Schaft	
	<input type="checkbox"/>	Form HA
	<input type="checkbox"/>	Form HB
	<input type="checkbox"/>	Form HE

Cooling / Kühlung	
<input type="checkbox"/> External Extern	
<input type="checkbox"/> Internal Intern	

Coating / Beschichtung	
<input type="checkbox"/>	Yes / Ja
<input type="checkbox"/>	No / Nein

Remarks:
Bemerkungen:

Order quantity: pieces
Auftragsmenge: Stücke

Expected delivery date:
Gewünschtes Lieferdatum:

Date · Datum:

Confirmation · Unterschrift :

C

Solid carbide drills
Vollhartmetallbohrer



Step straight-flute drill · Gerade genutete Stufen Bohrer (Non-standard Taylor made · Sonderwerkzeuge)

Name:	 Heltorfer Straße 12 40472 Düsseldorf Germany Fax: +49-(0)211-989240-111 E-Mail: info@zccct-europe.com
Company / Firma:	
Fax:	
Tel:	
E-mail:	

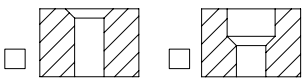
Machining information and Workpiece Material · Bearbeitungsinfo und Werkstückstoff

<p>Machined hole Bohrung</p>  <p>Size of small machined hole Kleiner Lochdurchmesser <input type="text"/> mm</p> <p>Tolerance of small machined hole Toleranz der kleinen Bohrung <input type="text"/></p> <p>Size of big machined hole Ø Großer Lochdurchmesser <input type="text"/> mm</p> <p>Tolerance of big machined hole Toleranz der großen Bohrung <input type="text"/></p> <p>Depth of machined hole Bohrtiefe <input type="text"/> mm</p>	<p><input type="checkbox"/> Grey cast iron Grauguss</p> <p><input type="checkbox"/> Nodular cast iron GGG Kugelgraphitguss</p> <p><input type="checkbox"/> Aluminium alloy Alulegierung</p> <p><input type="checkbox"/> Si Al alloy Si<10% Si-Alulegierung</p> <p><input type="checkbox"/> Si Al alloy Si≥10% Si-Alulegierung</p>	<p>Machined material trademark Spezieller Werkstoff <input type="text"/></p> <p>Tensile Strength · Zugfestigkeit <input type="text"/> N/mm²</p> <p>Hardness · Härte <input type="text"/></p>
<p>The straight-flute drill is widely used for cutting short ship materials from cast iron and common Al alloy to high Si Al alloy Gerade genutete Bohrer werden weitestgehend für die Bearbeitung von Gusseisen und Aluleg. bis Si-Aluleg. eingesetzt.</p>		

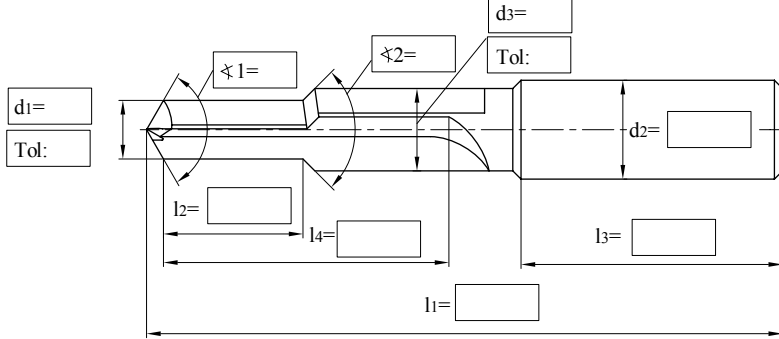
Tool information · Werkzeug Informationen

	<p>Shank · Schaft</p> <p>DIN6535</p> <p><input type="checkbox"/> Form HA</p> <p><input type="checkbox"/> Form HB</p> <p><input type="checkbox"/> Form HE</p>
<p>Cooling / Kühlung</p> <p><input type="checkbox"/> External Extern </p> <p><input type="checkbox"/> Internal Intern </p>	<p>Coating / Beschichtung</p> <p><input type="checkbox"/> Yes / Ja</p> <p><input type="checkbox"/> No / Nein</p>

Remarks: Bemerkungen:	
Order quantity: Auftragsmenge:	pieces Stücke
Expected delivery date: Gewünschtes Lieferdatum:	
Date · Datum:	Confirmation · Unterschrift:



Solid carbide drills
Vollhartmetallbohrer

Reaming - Reiben





Reamers - Reibahlen

Solid carbide reamers overview	C142	Übersicht VHM Reibahlen
Graphics identification	C142	Graphische Werkzeugbeschreibung
Code Key	C143	ISO Kennzeichnung
Solid carbide reamer program	C144-C147	VHM Reibahlen Programm
Recommended cutting datas	C148	Empfohlene Schnittdaten
Technical information	C149-C151	Technische Informationen
Order form for non-standard products	C152	Bestellformular für Sonderwerkzeuge

Reaming · Reiben

Solid carbide reamers · Vollhartmetall-Reibahlen

Solid carbide reamers overview · Übersicht VHM Reibahlen

Name Name	Type Typ	Shape Ausführung	Diameter range Durchmesser bereich Ø	Workpiece material Werkstück Material						Page Seite			
				P	M	K	N	S	H	Specification Spezifikation	Cutting datas Schnittdaten		
Right helical flute Rechts gedrallt	3101H7		Ø4-Ø20									C144	C148
Straight flute Gerade genutet	3102H7		Ø4-Ø20									C145	
Straight flute with inner hole Gerad genutet mit einem inneren Loch	3112H7		Ø4-Ø20	✓								C146	
Left helical flute Links gedrallt	3103H7		Ø4-Ø20									C147	

✓ = Very suitable · Sehr empfohlen
 ✓ = Suitable · Empfohlen

Solid carbide reamers icons information · VHM Reibahlen Grafische Beschreibung

- Precision class of reamed hole
- Bohrungstoleranzklasse

H7

The precision class of reamed hole reaches H7 specified in GB/T1800-1804
 Toleranzklasse H7
 angegeben in GB/T1800-1804

- Shank · Schaft



Straight shank
 Zylinderschaft

Solid carbide reamer Code Key · VHM Reibahlen ISO Kennzeichnung

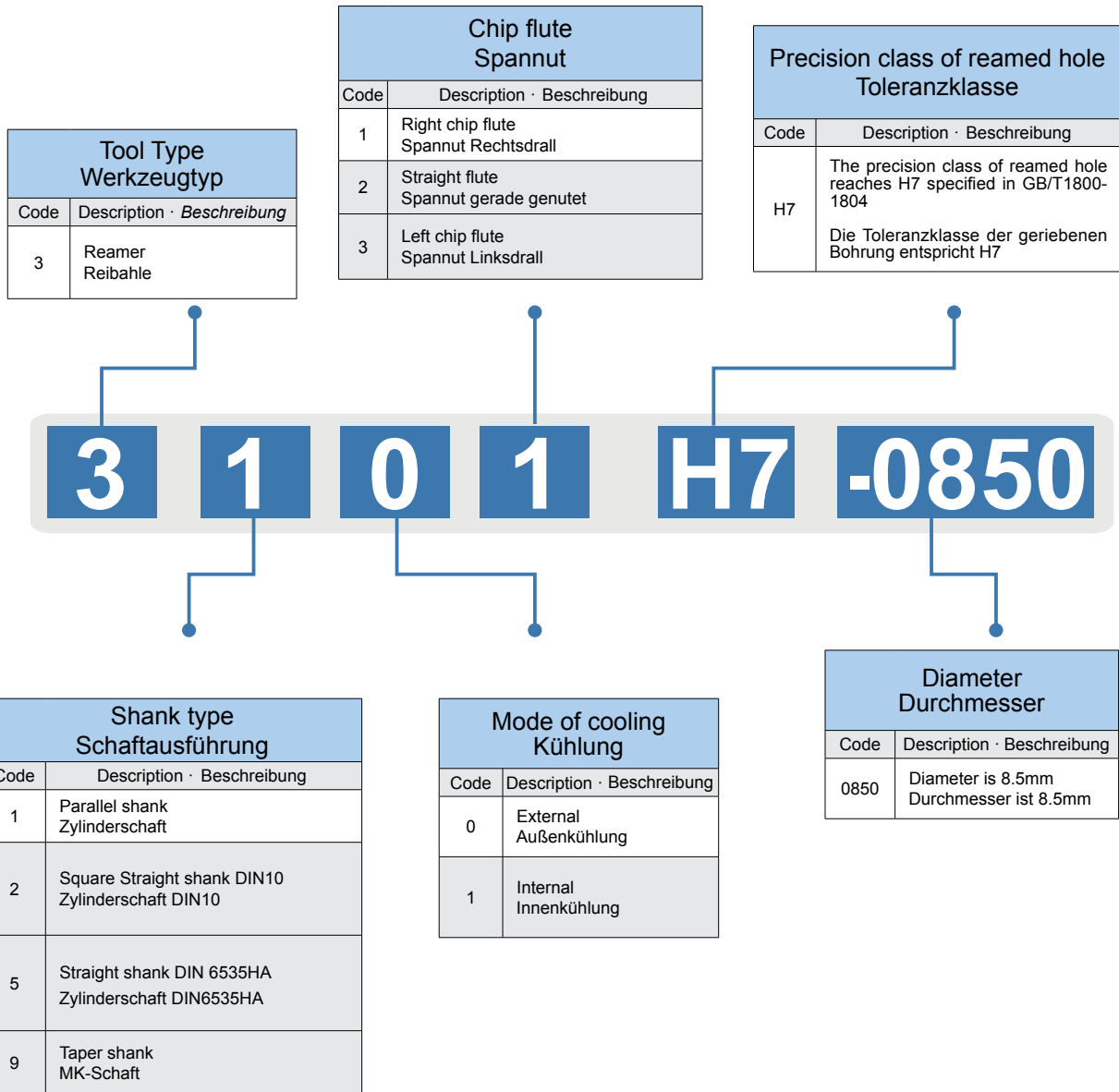

Reaming · Reiben

Solid carbide reamers · Vollhartmetall-Reibahlen

3101H7 with straight shank and right helical flute mit Zylinderschaft und rechtsgedrallter Spannute

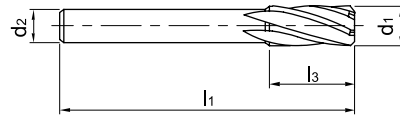

H7



Type Typ	Basic dimension(mm) · Basis Abmessungen				Number of teeth Zähnezahl	Grade · Sorte YK10F
	d ₁	d ₂ (h ₆)	l ₁	l ₃		
3101H7-0400	4.0	3.55	56	20	4	○
3101H7-0450	4.5	4.00	63	22	6	○
3101H7-0500	5.0	4.00	63	22	6	●
3101H7-0550	5.5	5.00	63	22	6	○
3101H7-0600	6.0	5.00	63	22	6	●
3101H7-0650	6.5	5.00	63	22	6	○
3101H7-0700	7.0	6.30	71	25	6	●
3101H7-0750	7.5	6.30	71	25	6	○
3101H7-0800	8.0	6.30	71	25	6	●
3101H7-0850	8.5	8.00	71	25	6	○
3101H7-0900	9.0	8.00	71	25	6	○
3101H7-0950	9.5	8.00	71	25	6	○
3101H7-1000	10.0	8.00	71	25	6	●
3101H7-1050	10.5	8.00	71	25	6	○
3101H7-1100	11.0	10.00	80	28	6	○
3101H7-1150	11.5	10.00	80	28	6	○
3101H7-1200	12.0	10.00	80	28	6	●
3101H7-1250	12.5	10.00	80	28	6	○
3101H7-1300	13.0	10.00	80	28	6	○
3101H7-1350	13.5	12.5	90	32	6	○
3101H7-1400	14.0	12.5	90	32	6	○
3101H7-1450	14.5	12.5	90	32	6	●
3101H7-1500	15.0	12.5	90	32	6	○
3101H7-1550	15.5	12.5	90	32	6	○
3101H7-1600	16.0	12.5	90	32	6	●
3101H7-1700	17.0	12.5	90	32	6	○
3101H7-1800	18.0	16.00	100	36	6	○
3101H7-1900	19.0	16.00	100	36	6	○
3101H7-2000	20.0	16.00	100	36	6	○

Material Overview · Material Übersicht

✓ = Very suitable · Sehr empfohlen
 ✓ = Suitable · Empfohlen

Grade Sorte	Workpiece material · Werkstückstoff									
	Mild steel Baustahl HB≤180	Carbon steel Alloy Steel Kohlenstoff-, Legierter Stahl	Hardened steel · Gehärteter Stahl			Stainless steel Rostfreier Stahl	Cast iron Gusseisen	Nodular cast iron GGG Kugelgra- phitguss	Aluminum alloy Aluleg.	Copper alloy Kupferleg
YK10F			~40HRC	~50HRC	~60HRC		✓	✓	✓	✓

● Ex Stock / ab Lager ○ On demand / auf Anfrage

3102H7 with straight shank and flute · mit Zylinderschaft und gerader Spannute

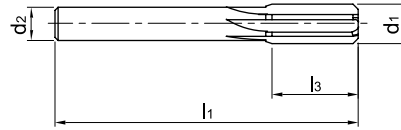

H7



Type Typ	Basic dimension(mm) · Basis Abmessungen				Number of teeth Zähnezahl	Grade · Sorte
	d1	d2(h6)	l1	l3		YK10F
3102H7-0400	4.0	3.55	56	20	4	○
3102H7-0450	4.5	4.00	63	22	6	○
3102H7-0500	5.0	4.00	63	22	6	●
3102H7-0550	5.5	5.00	63	22	6	○
3102H7-0600	6.0	5.00	63	22	6	●
3102H7-0650	6.5	5.00	63	22	6	○
3102H7-0700	7.0	6.30	71	25	6	○
3102H7-0750	7.5	6.30	71	25	6	○
3102H7-0800	8.0	6.30	71	25	6	○
3102H7-0850	8.5	8.00	71	25	6	○
3102H7-0900	9.0	8.00	71	25	6	○
3102H7-0950	9.5	8.00	71	25	6	○
3102H7-1000	10.0	8.00	71	25	6	●
3102H7-1050	10.5	8.00	71	25	6	●
3102H7-1100	11.0	10.00	80	28	6	○
3102H7-1150	11.5	10.00	80	28	6	○
3102H7-1200	12.0	10.00	80	28	6	○
3102H7-1250	12.5	10.00	80	28	6	○
3102H7-1300	13.0	10.00	80	28	6	●
3102H7-1350	13.5	12.5	90	32	6	○
3102H7-1400	14.0	12.5	90	32	6	○
3102H7-1450	14.5	12.5	90	32	6	●
3102H7-1500	15.0	12.5	90	32	6	○
3102H7-1550	15.5	12.5	90	32	6	○
3102H7-1600	16.0	12.5	90	32	6	○
3102H7-1700	17.0	12.5	90	32	6	○
3102H7-1800	18.0	16.00	100	36	6	○
3102H7-1900	19.0	16.00	100	36	6	○
3102H7-2000	20.0	16.00	100	36	6	○

Material Overview · Material Übersicht

✓ = Very suitable · Sehr empfohlen
 ✓ = Suitable · Empfohlen

Grade Sorte	Workpiece material · Werkstückstoff									
	Mild steel Baustahl HB≤180	Carbon steel Alloy Steel Kohlenstoff-, Legierter Stahl	Hardened steel · Gehärteter Stahl			Stainless steel Rostfreier Stahl	Cast iron Gusseisen	Nodular cast iron GGG Kugelgra- phitguss	Aluminum alloy Aluleg.	Copper alloy Kupferleg.
YK10F			~40HRC	~50HRC	~60HRC		✓	✓	✓	✓

Code key C143
ISO Kennzeichen

Cutting data C148
Schnittdaten

Technical Information C149-151
Technische Information.

Non-standart tailor made C152
Bestellformular für Sonderwerkzeuge

Reaming · Reiben

Solid carbide reamers · Vollhartmetall-Reibahlen

3112H7 with straight shank and flute · mit Zylinderschaft und gerader Spannute

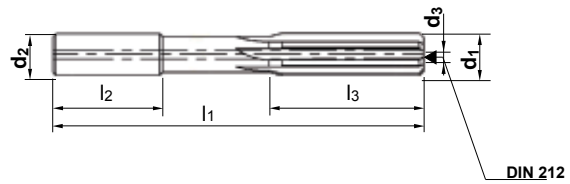

Type Typ	Basic dimension(mm) · Basis Abmessungen						Number of teeth Zähnezahl	Grade · Sorte KRG102
	d1 DIN 1420	d2(h6)	d3	l1	l3	l2		
3112H7-0400	4.0	4.0	0.6	70	20	28	6	●
3112H7-0500	5.0	5.0	1.0	70	22	28	6	●
3112H7-0600	6.0	6.00	1.0	100	22	36	6	●
3112H7-0700	7.0	8.00	1.3	110	25	42	6	●
3112H7-0800	8.0	8.00	1.3	110	25	42	6	●
3112H7-0900	9.0	10.00	2.0	110	25	42	6	●
3112H7-1000	10.0	10.00	2.0	110	25	38	6	●
3112H7-1100	11.0	12.00	2.0	110	28	38	6	●
3112H7-1200	12.0	12.00	2.0	110	28	38	6	●
3112H7-1300	13.0	14.00	2.0	110	28	38	6	●
3112H7-1400	14.0	14.00	2.0	110	32	38	6	●
3112H7-1500	15.0	16.00	2.0	110	32	38	6	●
3112H7-1600	16.0	16.00	2.0	150	32	52	6	●
3112H7-1800	18.0	18.00	3.0	150	36	52	6	●
3112H7-2000	20.0	20.00	3.0	150	36	50	6	●



Solid carbide reamers
Vollhartmetall Reibahlen

Material Overview · Material Übersicht

✓ = Very suitable · Sehr empfohlen
✓ = Suitable · Empfohlen

Grade Sorte	Workpiece material · Werkstückstoff									
	Mild steel Baustahl HB≤180	Carbon steel Alloy Steel Kohlenstoff-, Legierter Stahl	Hardened steel · Gehärteter Stahl			Stainless steel Rostfreier Stahl	Cast iron Gusseisen	Nodular cast iron GGG Kugelgra- phitguss	Aluminum alloy Aluleg.	Copper alloy Kupferleg.
KRG102		✓	✓				✓	✓		

● Ex Stock / ab Lager ○ On demand / auf Anfrage

3103H7 with straight shank and left helical flute mit Zylinderschaft und linksgedrallter Spannute

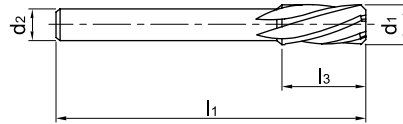

Type Typ	Basic dimension(mm) · Basis Abmessungen				Number of teeth Zähnezahl	Grade · Sorte YK10F
	d1	d2(h6)	l1	l3		
3103H7-0400	4.0	3.55	56	20	4	●
3103H7-0450	4.5	4.00	63	22	6	○
3103H7-0500	5.0	4.00	63	22	6	●
3103H7-0550	5.5	5.00	63	22	6	○
3103H7-0600	6.0	5.00	63	22	6	●
3103H7-0650	6.5	5.00	63	22	6	○
3103H7-0700	7.0	6.30	71	25	6	○
3103H7-0750	7.5	6.30	71	25	6	○
3103H7-0800	8.0	6.30	71	25	6	●
3103H7-0850	8.5	8.00	71	25	6	○
3103H7-0900	9.0	8.00	71	25	6	○
3103H7-0950	9.5	8.00	71	25	6	○
3103H7-1000	10.0	8.00	71	25	6	●
3103H7-1050	10.5	8.00	71	25	6	○
3103H7-1100	11.0	10.00	80	28	6	○
3103H7-1150	11.5	10.00	80	28	6	●
3103H7-1200	12.0	10.00	80	28	6	○
3103H7-1250	12.5	10.00	80	28	6	○
3103H7-1300	13.0	10.00	80	28	6	○
3103H7-1350	13.5	12.5	90	32	6	○
3103H7-1400	14.0	12.5	90	32	6	○
3103H7-1450	14.5	12.5	90	32	6	○
3103H7-1500	15.0	12.5	90	32	6	●
3103H7-1550	15.5	12.5	90	32	6	○
3103H7-1600	16.0	12.5	90	32	6	○
3103H7-1700	17.0	12.5	90	32	6	○
3103H7-1800	18.0	16.00	100	36	6	○
3103H7-1900	19.0	16.00	100	36	6	○
3103H7-2000	20.0	16.00	100	36	6	○

Material Overview · Material Übersicht

✓ = Very suitable · Sehr empfohlen
 ✓ = Suitable · Empfohlen

Grade Sorte	Workpiece material · Werkstückstoff									
	Mild steel Baustahl HB≤180	Carbon steel Alloy Steel Kohlenstoff-, Legierter Stahl	Hardened steel · Gehärteter Stahl			Stainless steel Rostfreier Stahl	Cast iron Gusseisen	Nodular cast iron GGG Kugelgra- phitguss	Aluminum alloy Aluleg.	Copper alloy Kupferleg.
YK10F							✓	✓	✓	✓

Code key C143
ISO Kennzeichen

Cutting data C148
Schnittdaten

Technical Information C149-151
Technische Information.

Non-standart tailor made C152
Bestellformular für Sonderwerkzeuge

Reaming · Reiben

Solid carbide reamers · Vollhartmetall-Reibahlen

3101H7 / 3102H7 / 3103H7

Workpiece material Werkstückstoff	Cast iron Nodular cast iron GGG Gusseisen, Kugelgraphitguss			Copper alloy Kupferlegierungen			Aluminium alloy Alulegierungen		
Vc	8~16m/min			10~25m/min			15~30 m/min		
Ø (mm)	n (min ⁻¹)	f (mm/r)	Tolerance Toleranz (mm)	n (min ⁻¹)	f (mm/r)	Tolerance Toleranz (mm)	n (min ⁻¹)	f (mm/r)	Tolerance Toleranz (mm)
4	950	0.04~0.06	0.1~0.2	1600	0.04~0.06	0.1~0.2	2000	0.04~0.06	0.1~0.2
5	760	0.05~0.09	0.1~0.2	1300	0.05~0.09	0.1~0.2	1600	0.05~0.09	0.1~0.2
6	640	0.06~0.12	0.1~0.2	1050	0.06~0.12	0.1~0.2	1300	0.06~0.12	0.1~0.2
7	550	0.07~0.14	0.1~0.2	910	0.07~0.14	0.1~0.2	1150	0.07~0.14	0.1~0.2
8	480	0.08~0.16	0.1~0.2	800	0.08~0.16	0.1~0.2	1000	0.08~0.16	0.1~0.2
9	430	0.09~0.18	0.1~0.2	710	0.09~0.18	0.1~0.2	890	0.09~0.18	0.1~0.2
10	380	0.10~0.20	0.1~0.2	640	0.10~0.20	0.1~0.2	800	0.10~0.20	0.1~0.2
11	350	0.11~0.22	0.1~0.2	580	0.11~0.22	0.1~0.2	720	0.11~0.22	0.1~0.2
12	320	0.12~0.24	0.1~0.2	530	0.12~0.24	0.1~0.2	660	0.12~0.24	0.1~0.2
13	290	0.13~0.26	0.1~0.2	490	0.13~0.26	0.1~0.2	610	0.13~0.26	0.1~0.2
14	270	0.14~0.28	0.1~0.2	460	0.14~0.28	0.1~0.2	570	0.14~0.28	0.1~0.2
15	250	0.15~0.30	0.1~0.2	430	0.15~0.30	0.1~0.2	530	0.15~0.30	0.1~0.2
16	240	0.16~0.32	0.1~0.2	400	0.16~0.32	0.1~0.2	500	0.16~0.32	0.1~0.2
17	225	0.18~0.34	0.1~0.2	380	0.18~0.34	0.1~0.2	470	0.18~0.34	0.1~0.2
18	210	0.20~0.36	0.1~0.2	350	0.20~0.36	0.1~0.2	440	0.20~0.36	0.1~0.2
19	200	0.22~0.38	0.1~0.2	340	0.22~0.38	0.1~0.2	420	0.22~0.38	0.1~0.2
20	190	0.24~0.40	0.1~0.2	320	0.24~0.40	0.1~0.2	400	0.24~0.40	0.1~0.2

1. Please select the holder with high rigidity and precision.
2. Make sure supply sufficient coolant.
3. Please adjust cutting parameters according to workpiece and machine rigidity.

1. Bitte wählen Sie einen Halter mit hoher Stabilität und Genauigkeit.
2. Stellen Sie sicher, dass ausreichend Kühlmittel bereit gestellt wird.
3. Bitte stimmen Sie die Schnittdaten mit dem Werkstück und der Stabilität der Maschine ab.



Terminology of reamer · Terminology von Reibahlen

● Version · Ausführung

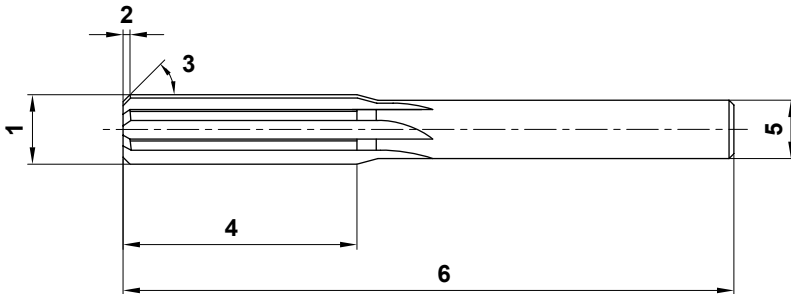

- | | |
|---------------------------|-------------------------|
| 1. Cutting diameter | 1. Schneidendurchmesser |
| 2. Cutting chamfer length | 2. Schneidenfasenlänge |
| 3. Approach angle | 3. Einstellwinkel |
| 4. Cutting edge length | 4. Schneidenlänge |
| 5. Shank diameter | 5. Schaftdurchmesser |
| 6. Overall length | 6. Gesamtlänge |

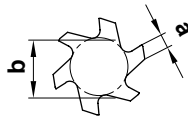

- | | |
|------------------|--------------------|
| a. Margin width | a. Schneidenstärke |
| b. Core diameter | b. Kerndurchmesser |

Reaming is the semi-finishing and finishing of an existing hole to achieve precise size, high surface quality, perfect roundness and cylindricity etc.

In order to achieve precise hole in reaming process, it must to determine the reamer diameter correctly. Therefore, it is need to consider allowance determined by workpiece material and machining conditions. In addition, it is also need to select the cutting conditions correctly except using high precision reamer to achieve good surface quality.

The reaming precision is mainly decided by diameter and radial run-out. With respect to cutting condition, it is better to select low speed cutting considering to improve machining precision, but it also must take upper limit of machining efficiency into consideration.

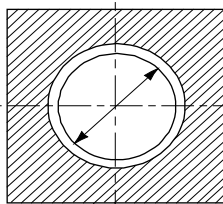

Enlarge allowance
Ø Toleranz / Aufmaß

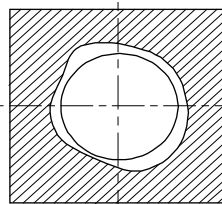

Roundness
Rundheit

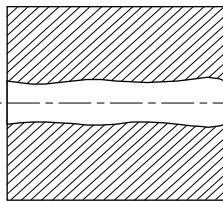

Cylindricity
Zylindrizitat

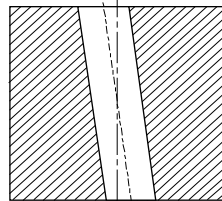

Verticality
vertikale Abweichung

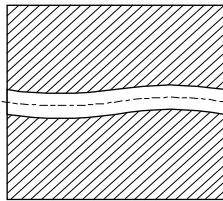

Straightness
Geradheit

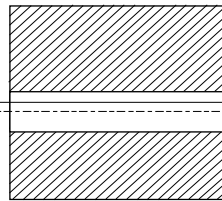

Off-centre
Zentrumabweichung

Als Reiben bezeichnet man die Vor- oder Fertigbearbeitung einer vorhandenen Bohrung innerhalb einer engen Toleranz, mit hoher Oberflächenqualität, perfekter Rundheit, Zylindrizität etc.

Um eine exakte Bohrung durch Reiben zu erzielen, kommt es auf die Auswahl der Reibahle und des Reibahldurchmessers an.

Zusätzlich sind die Bohrungstoleranzen, die Werkstückstoffe und die Maschinenbedingungen zu berücksichtigen.

Die Bohrungsqualität wird darüber hinaus stark von dem Rundlauf des Werkzeugs beeinflusst. Die Schnittdaten sollten zur Erzielung einer präzisen Bohrung eher etwas niedriger gewählt werden, ohne allerdings die Wirtschaftlichkeit unberücksichtigt zu lassen.

Reaming · Reiben

Solid carbide reamers · Vollhartmetall-Reibahlen

Common problems Fehler	Solutions	Lösungen
Over-size holes Bohrung zu groß	<ol style="list-style-type: none"> 1. Reduce diameter of reamer. 2. The center of reamer is not in alignment with hole center, adjust the concentricity of hole and reamer. 3. Large radial run-out of reamer, good radial run-out is a Key Keil to successful reaming 4. Scratches on reamer shank. 5. Select a suitable coolant. 6. Adjust cutting parameters. 	<ol style="list-style-type: none"> 1. Reibahldurchmesser reduzieren. 2. Zentrität von Reibahle und Bohrung prüfen. 3. Rundlaufgenauigkeit der Reibahle prüfen. 4. Reibahlenschaft auf Kratzer oder Verletzungen prüfen. 5. Richtiges Kühlmittel verwenden. 6. Schnittdaten anpassen.
Smaller holes Bohrung zu klein	<ol style="list-style-type: none"> 1. Increase diameter of reamer. 2. Reduce rotating speed. 3. Reduce the margin width. 4. Excessive tool wear, please conduct cutting after regrinding. 5. Thermal expansion coefficient of workpiece is too large, please keep it cooled enough. 	<ol style="list-style-type: none"> 1. Reibahldurchmesser erhöhen. 2. Schnittgeschwindigkeit reduzieren. 3. Aufmaß reduzieren. 4. zu großer Werkzeugverschleiß. (Reibahle nachschleifen oder neu) 5. Der thermische Ausdehnungskoeffizient des Werkstückstoffs ist zu groß. Für ausreichende Kühlung sorgen.
Poor hole roundness & straightness Bohrung unrund & verlaufen	<ol style="list-style-type: none"> 1. Ensure better roundness of reamer chamfer. 2. Low rigidity make the overhang as short as possible if no inference. 3. Check radial run-out after clamping reamer. 4. Adjust the concentricity of hole and reamer. 5. Ensure reaming allowance equality. 	<ol style="list-style-type: none"> 1. Rundlaufgenauigkeit der Reibahlenfase sicherstellen. 2. Geringe Stabilität, Überhang reduzieren. 3. Rundlaufgenauigkeit der Reibahle im geklemmten Zustand prüfen. 4. Konzentrität zwischen Reibahle und Bohrung justieren. 5. Bohrergeometrie prüfen und sicherstellen.
Poor hole surface quality schlechte Oberflächenqualität	<ol style="list-style-type: none"> 1. The hole surface roughness of entering part is bad. 2. Reduce rotating speed. 3. Ensure correct reaming allowance, too large or too small both will result bad surface roughness. 4. Select the reamer with large chip pocket, avoid chip jamming. 5. Increase clearance angle of reamer entering part . 6. Check whether there are built-up on chamfer and margin land. 7. Increase the rigidity of machine, holder and reamer . 8. Ensure whether the type of reamer head is suitable for the workpiece. 9. Increase the margin width and land width appropriately. 	<ol style="list-style-type: none"> 1. Die Oberflächenqualität im Anschnittbereich prüfen und gegebenenfalls verbessern. 2. Schnittgeschwindigkeit reduzieren. 3. Richtiges Reibaufmaß sicher stellen. Zu gering oder zu groß bringen schlechte Oberflächen. 4. Reibahlen mit ausreichend großem Spanraum verwenden. 5. Freiwinkel im Anschnitt der Reibahle vergrößern. 6. Anschnittfase der Reibahle auf Verschleiß oder Aufbauschneide prüfen. 7. Stabilität der Maschine, Aufnahme und Reibahle gewährleisten. 8. Richtige Auswahl der Reibahle für den entsprechenden Einsatz prüfen. 9. Bohrungsaufmaß prüfen.
Hole precision is worse Geringe Bohrungsqualität	<ol style="list-style-type: none"> 1. In return pass, the reamer should be pulled out of hole when rotating at the same direction as before. Opposite rotation must be prohibited. 2. Reduce rotating speed. 3. Select the reamer with more lips. 4. Increase the margin width appropriately, enhance its guiding performance and extrusion effect. 5. Improve reamer lubricating property by surface treatment. 6. Select a suitable coolant. 	<ol style="list-style-type: none"> 1. Reibahle in Schnittrichtung zurück ziehen. 2. Schnittgeschwindigkeit reduzieren 3. Reibahlen mit mehr Schneiden einsetzen. 4. Schneidenausführung, Rundlauffase und Bohrerführung verbessern. Auf Zentrität und Rundlauf prüfen. 5. Kühlmittelzuführung verbessern. 6. Auswahl des optimalen Kühlmittelschmierstoffs.



Common problems Fehler	Solutions	Lösungen
Reamer breakage, thermal damage Reibahlenbruch und termische Verformung	<ol style="list-style-type: none"> 1. The guiding hole is defective before reaming, check drill and linearity. 2. Adjust machining allowance to avoid tool breakage caused by too large allowance. 3. If the chip removal is not fluent, select a reamer with larger chip pocket. 4. Ensure supply insufficient coolant. 5. Adjust rotating speed and feed rate appropriately. 6. Increase the rigidity of machine, holder and reamer . 7. Improve the sharpness of reamer, make cutting light and fast. 8. Excessive wear on cutting edge, reach or surpass tool life, recommend to change tool or regrind. 	<ol style="list-style-type: none"> 1. Die Führungsbohrung ist qualitativ unzureichend. Bohrer und Bohrungsachse prüfen. 2. Bearbeitungsaufmaß nicht zu groß wählen. 3. Reibahlen mit ausreichend großen Spanraum wählen. 4. Ausreichende Kühlmittelmenge sicherstellen. 5. Richtige Schnittgeschwindigkeit und Vorschübe einstellen. 6. Stabilität der Maschine, Aufnahme und Werkzeug verbessern. 7. Schneidenschärfe der Reibahle verbessern. 8. Bei zu hohem Schneidenschleiß das Werkzeug wechseln oder Nachschleifen.
Damage on reamer shank Reibahlenschacht Beschädigung	<ol style="list-style-type: none"> 1. Check whether the shank hardness is enough, too low hardness will cause deformation, too high hardness may cause breakage. 2. Check the conjunction of holder and bush, don't use the defective holder. 	<ol style="list-style-type: none"> 1. Die vorgegebene Härte des Schaftes prüfen. 2. Spannhülse und Halter auf Beschädigung prüfen.
Short tool life Kurze Standzeit	<ol style="list-style-type: none"> 1. Enhance reamer's cutting edge hardness. 2. Check the coolant. 3. Change the straight flute to helical flute. 4. Check all factors affecting machining precision. 	<ol style="list-style-type: none"> 1. Reibahlen mit verschleißfesteren Schneiden wählen. 2. Kühlmittelzufuhr prüfen. 3. Wechsel von gerade- zu spiralgenuteten Reibahlen. 4. Prüfen Sie die Faktoren, die die Bearbeitungspräzision beeinflussen.
Scratches on hole surface Zerkratzte Bohrungsoberfläche	<ol style="list-style-type: none"> 1. Check no built-up on reamer surface. 2. Improve workpiece holding. 	<ol style="list-style-type: none"> 1. Schneide auf Aufbauschneidenbildung untersuchen und gegebenenfalls Schnittdaten korrigieren. 2. Werkstückspannung verbessern.
Trumpet-shaped entry hole Bohrungseintrittsbereich zu groß	<ol style="list-style-type: none"> 1. Improve workpiece holding. 2. Check radial run-out after clamping reamer. 3. The center of reamer is not in alignment with hole center, adjust the concentricity of hole and reamer. 	<ol style="list-style-type: none"> 1. Werkstückspannung verbessern. 2. Rundlauf der Reibahle im geklemmten Zustand prüfen. 3. Das Zentrum des Werkzeuges stimmt nicht mit dem Zentrum der Bohrung überein. Zentrität justieren.

Reaming · Reiben

Solid carbide reamers · Vollhartmetall-Reibahlen

Non-standard Taylor made · Sonderwerkzeuge

Name:	 <p>Heltorfer Straße 12 40472 Düsseldorf Germany Fax: +49-(0)211-989240-111 E-Mail: info@zccct-europe.com</p>
Company / Firma:	
Fax:	
Tel:	
E-mail:	

Machining information and Workpiece Material · Bearbeitungsinfo und Werkstückstoff

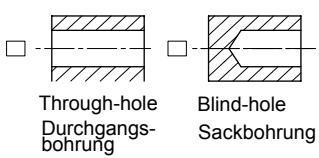
<p>Machined hole Bohrung</p>  <p>Through-hole Durchgangsbohrung</p> <p>Blind-hole Sackbohrung</p> <p>Size of machined hole Lochdurchmesser <input type="text"/> mm</p> <p>Tolerance of machined hole Toleranz der Bohrung <input type="text"/></p> <p>Depth of machined hole Bohrtiefe <input type="text"/> mm</p>	<input type="checkbox"/> Grey cast iron Grauguss <input type="checkbox"/> Nodular cast iron GGG Kugelgraphitguss <input type="checkbox"/> Aluminium alloy Alulegierung <input type="checkbox"/> Si Al alloy Si<10% Si-Alulegierung. <input type="checkbox"/> Si Al alloy Si 10% Si-Alulegierung.	<p>Machined material trademark Spezieller Werkstückstoff</p> <input type="text"/> <p>Tensile Strength · Zugfestigkeit</p> <input type="text"/> N/mm ² <p>Hardness · Härte</p> <input type="text"/>
---	---	--

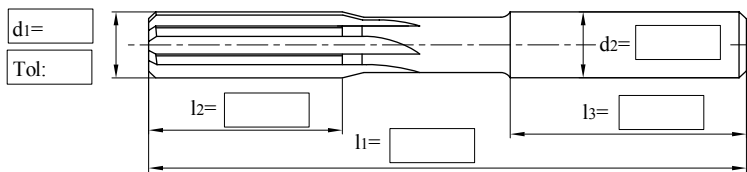

Tool information · Werkzeug-Informationen

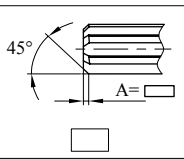
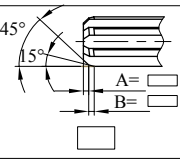
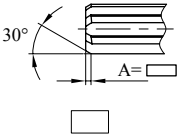
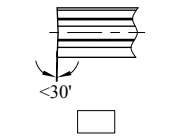

DIN6535	Shank · Schaft	
	<input type="checkbox"/>	Form HA
	<input type="checkbox"/>	Form HB
	<input type="checkbox"/>	Form HE

Approach angle
Winkelangabe an der Hauptschneide

 <p>45° A= <input type="text"/></p>	 <p>45° 15° A= <input type="text"/> B= <input type="text"/></p>
 <p>30° A= <input type="text"/></p>	 <p><30° A= <input type="text"/></p>

Cutter rotating direction · Drehrichtung	
Right rotating rechts gedreht	 <input type="checkbox"/>
Straight flute gerade genutet	 <input type="checkbox"/>
Left rotating links gedreht	 <input type="checkbox"/>

Cooling / Kühlung	
<input type="checkbox"/> External Extern	
<input type="checkbox"/> Internal Intern	

Coating Beschichtung	
<input type="checkbox"/> Yes / Ja	
<input type="checkbox"/> No / Nein	

Remarks:
Bemerkungen:

Order quantity: pieces
Auftragsmenge: Stücke

Expected delivery date:
Gewünschtes Lieferdatum:

Date · Datum:

Confirmation · Unterschrift:



Solid carbide reamers
Vollhartmetall Reibahlen

Threading · Gewinde







Threading tools · Gewindewerkzeuge

Threading tools overview	C154	Übersicht Gewindewerkzeuge
Graphics identification	C154	Graphische Werkzeugbeschreibung
Threading tools code key	C155	ISO Kennzeichnung
Detail information	C153-C173	Detaillierte Informationen
Solid carbide threading tools	C156-C167	VHM Gewindeformer und Gewindebohrer
Solid carbide threading end mills	C169-C170	VHM Gewindefräser
Recommended cutting data	C171	Empfohlene Schnittdaten
Technical information	C172	Technische Information
Order form for non-standard products	C173	Bestellformular für Sonderwerkzeuge

Threading · Gewindebearbeitung

Solid carbide taps and cutter · Vollhartmetall-Gewindebohrer, -fräser

Threading tool overview · Übersicht VHM-Gewindebohrer, -fräser

Name	Type Typ	Shape Ausführung	Diameter range Durchmesserbereich Ø	Workpiece material Werkstückstoff								Page Seite	
				P	M	K	N	S	H	Specification Spezifikation	Cutting datas Schmittdaten		
				Carbon steel Kohlenstoff - Stahl	Alloy steel Leg. Stahl	Stainless steel Rostfreier Stahl	Cast iron Gusseisen	Aluminum alloy Alulegierung	Copper alloy Kupferlegierung			Heat resist. alloy Warmfeste Leg.	High hard. steel gehärteter Stahl
Thread forming tap Gewindeformer	4122A		M1-M2.5						✓				C156
	4222A		M3-M16						✓				C157
	4122M		M1-M2.5	✓		✓		✓					C158
	4222M		M3-M16	✓		✓		✓					C158
Helical-flute tap Spiral genutet	4201C		M3-M16				✓						C160
	4201A							✓					C164
Straight-flute tap Gerade genutet	4202C		M3-M16				✓						C162
	4202A							✓					C166
Threading end mills Gewindefräser	4111		M3-M20	✓	✓		✓	✓					C169

✓ = Very suitable · Sehr empfohlen
 ✓ = Suitable · Empfohlen

Graphics identification · Graphische Werkzeugbeschreibung

Shank · Schaft



Straight shank
Zylinderschaft



Square Straight shank as per DIN10
DIN 10 Schaft

Thread profile angle of tap Winkel des Gewindeprofils



60°

Tolerance class of screw thread Toleranzklasse des Gewindes



6H



6HX

Threading · Gewindebearbeitung

Solid carbide taps and cutter · Vollhartmetall-Gewindebohrer, -fräser

Threading taps and cutter Code Key · ISO Kennzeichnung Gewindefräser, -bohrer

Tool Type Werkzeugtyp	
Code	Description · Beschreibung
4	Threading cutter Gewinde-Bearbeitungs- Werkzeug

Chip flute Spannut	
Code	Description · Beschreibung
1	Right chip flute · Spannut Rechtsdrall
2	Straight flute · Spannut gerade
3	Left chip flute · Spannut Linksdrall

Material Material	
Code	Description · Beschreibung
A	Aluminum alloy Aluminumlegierung
C	Cast iron Grauguss
M	Stainless steel Rostfreier Stahl
P	Carbon steel Kohlenstoff - Stahl
H	High hard. steel gehärteter Stahl

4 2 0 1 A C S -M5x0.5 -6H

Shank Schaftausführung	
Code	Description · Beschreibung
1	Straight shank / Zylinderschaft
2	Square Straight shank as per DIN10 Zylinderschaft DIN10
5	Straight shank as per DIN 6535HA Zylinderschaft DIN 6535HA
9	Tapered shank Konischer Schaft

Cooling Kühlung	
Code	Description · Beschreibung
Default Standard	External · Extern
C	Internal · Intern

Specification Spezifikation	
Code	Description · Beschreibung
M5	Nominal diameter of standard threading cutters is M5 Der angegebene Durchmesser ist M 5
0.5	Pitch Steigung

Typ of function Art der Bearbeitung	
Code	Description · Beschreibung
0	Tap Gewindebohrer
1	Thread milling cutter Gewindefräser
2	Thread forming tap Gewindeformer

Hole shape Bohrungsausführung	
Code	Description · Beschreibung
Default Standard	Through-hole Durchgangsbohrung
S	Blind-hole Sackbohrung

Precision class Präzisionsklasse	
Code	Description · Beschreibung
6H	ISO metric thread ISO metrische Gewinde
6HX	General pitch thread "General pitch" Gewinde

C

Solid carbide drills
Vollhartmetallbohrer

Threading · Gewindebearbeitung

Solid carbide taps and cutter · Vollhartmetall-Gewindebohrer, -fräser

4122A
4222A

Thread forming tap for aluminum alloy machining
Gewindeformer zur Bearbeitung von Aluminiumlegierungen

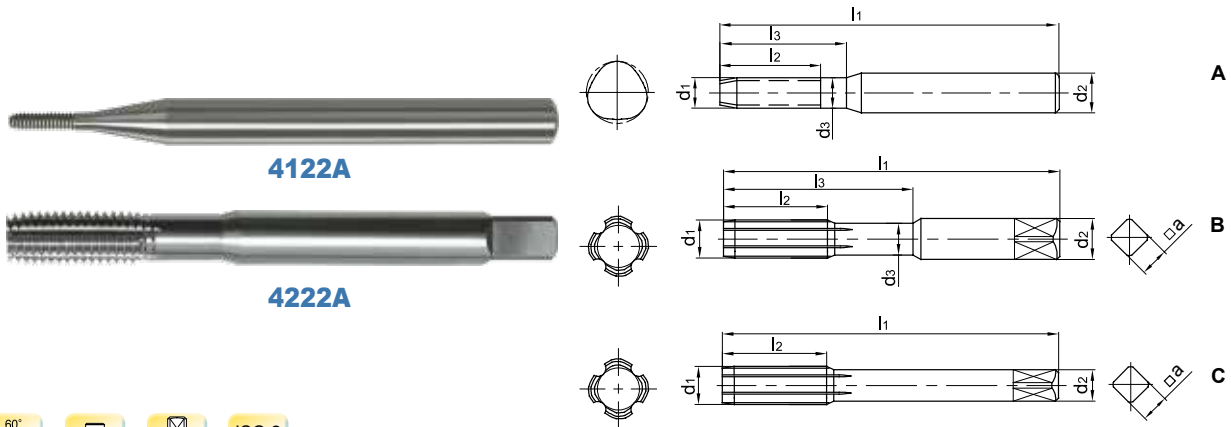

Type Typ	Cooling Kühlung	Basic dimension(mm) Basis Abmessungen											Number of teeth Zähne- anzahl	Grade Sorte YK40F	Coredrill Kernbohrer d		
		Taper length Anschmitt- länge	d1	P	d2	d3	l1	l2	l3	a x a	Thread- profile Gewinde- profil	Geometry Ausführung					
4122A-M1*0.25-6H	Extern	3P	M1	0.25	3		40	5					60°	A	3	●	0.9
4122AS-M1*0.25-6H	Extern	1.5P	M1	0.25	3		40	5					60°	A	3	●	0.9
4122A-M1.2*0.25-6H	Extern	3P	M1.2	0.25	3		40	5					60°	A	3	●	1.1
4122AS-M1.2*0.25-6H	Extern	1.5P	M1.2	0.25	3		40	5					60°	A	3	●	1.1
4122A-M1.6*0.35-6H	Extern	3P	M1.6	0.35	3	1.1	40	5	11				60°	A	3	●	1.47
4122AS-M1.6*0.35-6H	Extern	1.5P	M1.6	0.35	3	1.1	40	5	11				60°	A	3	●	1.47
4122A-M2*0.4-6H	Extern	3P	M2	0.4	3	1.5	45	6	12				60°	A	3	●	1.85
4122AS-M2*0.4-6H	Extern	1.5P	M2	0.4	3	1.5	45	6	12				60°	A	3	●	1.85
4122A-M2.5*0.45-6H	Extern	3P	M2.5	0.45	3	1.9	50	6	14				60°	A	3	●	2.33
4122AS-M2.5*0.45-6H	Extern	1.5P	M2.5	0.45	3	1.9	50	6	14				60°	A	3	●	2.33
4222A-M3*0.5-6H	Extern	3P	M3	0.5	3.5	2.3	56	6	18	2.7			60°	B	4	○	2.8
4222AS-M3*0.5-6H	Extern	1.5P														○	
4222A-M4*0.5-6H	Extern	3P	M4	0.5	4.5	3.1	63	8	21	3.4			60°	B	4	●	3.8
4222AS-M4*0.5-6H	Extern	1.5P														●	
4222A-M4*0.7-6H	Extern	3P	M4	0.7	4.5	3.1	63	8	21	3.4			60°	B	4	○	3.7
4222AS-M4*0.7-6H	Extern	1.5P														○	
4222A-M5*0.5-6H	Extern	3P	M5	0.5	6	4.3	70	10	25	4.9			60°	B	4	●	4.8
4222AS-M5*0.5-6H	Extern	1.5P														●	
4222A-M5*0.8-6H	Extern	3P	M5	0.8	6	4	70	10	25	4.9			60°	B	4	○	4.65
4222AS-M5*0.8-6H	Extern	1.5P														○	
4222A-M6*0.75-6H	Extern	3P	M6	0.75	6	5	80	12	30	4.9			60°	B	4	●	5.7
4222AS-M6*0.75-6H	Extern	1.5P														●	
4222A-M6*1-6H	Extern	3P	M6	1	6	4.7	80	12	30	4.9			60°	B	4	○	5.6
4222AS-M6*1-6H	Extern	1.5P														○	
4222A-M7*1-6H	Extern	3P	M7	1	7	5.7	80	14	30	5.5			60°	B	4	●	6.6
4222AS-M7*1-6H	Extern	1.5P														●	

● Ex Stock / ab Lager ○ On demand / auf Anfrage

Threading · Gewindebearbeitung

Solid carbide taps and cutter · Vollhartmetall-Gewindebohrer, -fräser

Type Typ	Cooling Kühlung	Basic dimension(mm) Basis Abmessungen											Number of teeth Zähne- anzahl	Grade Sorte		Coredrill Kernbohrer
		Taper length Anschnit- länge	d ₁	P	d ₂	d ₃	l ₁	l ₂	l ₃	a×a	Thread- profile Gewinde- profil	Geometry Ausführung		YK40F	d	
4222A-M8*1-6H	Extern	3P	M8	1	8	6.7	90	16	35	6.2	60°	B	4	●	7.6	
4222AS-M8*1-6H	Extern	1.5P												●		
4222A-M8*1.25-6H	Extern	3P	M8	1.25	8	6.4	90	16	35	6.2	60°	B	4	○	7.45	
4222AS-M8*1.25-6H	Extern	1.5P												○		
4222A-M10*1-6H	Extern	3P	M10	1	10	8.7	100	20	39	8	60°	B	5	●	9.6	
4222AS-M10*1-6H	Extern	1.5P												●		
4222A-M10*1.25-6H	Extern	3P	M10	1.25	10	8.4	100	20	39	8	60°	B	5	●	9.45	
4222AS-M10*1.25-6H	Extern	1.5P												●		
4222A-M10*1.5-6H	Extern	3P	M10	1.5	10	8.1	100	20	39	8	60°	B	5	○	9.35	
4222AS-M10*1.5-6H	Extern	1.5P												○		
4222AC-M10*1.5-6H	Intern	3P												○		
4222ACS-M10*1.5-6H	Intern	1.5P												○		
4222A-M12*1.25-6H	Extern	3P	M12	1.25	9		110	24		7	60°	C	5	●	11.45	
4222AS-M12*1.25-6H	Extern	1.5P												●		
4222A-M12*1.5-6H	Extern	3P	M12	1.5	9		110	24		7	60°	C	5	●	11.35	
4222AS-M12*1.5-6H	Extern	1.5P												●		
4222A-M12*1.75-6H	Extern	3P	M12	1.75	9		110	24		7	60°	C	5	○	11.25	
4222AS-M12*1.75-6H	Extern	1.5P												○		
4222AC-M12*1.75-6H	Intern	3P												○		
4222ACS-M12*1.75-6H	Intern	1.5P												○		
4222A-M14*1.5-6H	Extern	3P	M14	1.5	11		110	26		9	60°	C	6	●	13.35	
4222AS-M14*1.5-6H	Extern	1.5P												●		
4222A-M14*2-6H	Extern	3P	M14	2	11		110	26		9	60°	C	6	●	13.1	
4222AS-M14*2-6H	Extern	1.5P												●		
4222A-M16*1.5-6H	Extern	3P	M16	1.5	12		110	27		9	60°	C	6	●	15.35	
4222AS-M16*1.5-6H	Extern	1.5P												●		
4222A-M16*2-6H	Extern	3P	M16	2	12		110	27		9	60°	C	6	○	15.1	
4222AS-M16*2-6H	Extern	1.5P												○		
4222AC-M16*2-6H	Intern	3P												○		
4222ACS-M16*2-6H	Intern	1.5P												○		

Material Overview · Material Übersicht

✓ = Very suitable · Sehr empfohlen
 ✓ = Suitable · Empfohlen

Grade Sorte	Workpiece material · Werkstückstoff									
	Mild steel Baustahl HB≤180	Carbon steel Alloy Steel Kohlenstoff- Legierter Stahl	Hardened steel · Gehärteter Stahl			Stainless steel Rostfreier Stahl	Cast iron Gusseisen	Nodular cast iron GGG Kugelgra- phitguss	Aluminum alloy Aluleg.	Copper alloy Kupferleg.
YK40F									✓	

Code key C 155
ISO Kennzeichen

Cutting data C171
Schnittdaten

Technical Information C172-173
Technische Information.

Non-standard tailor made C174
Bestellformular für Sonderwerkzeuge

Threading · Gewindebearbeitung

Solid carbide taps and cutter · Vollhartmetall-Gewindebohrer, -fräser

4122M
4222M

Thread forming tap for stainless steel machining
Gewindeformer zur Bearbeitung von rostfreiem Stahl

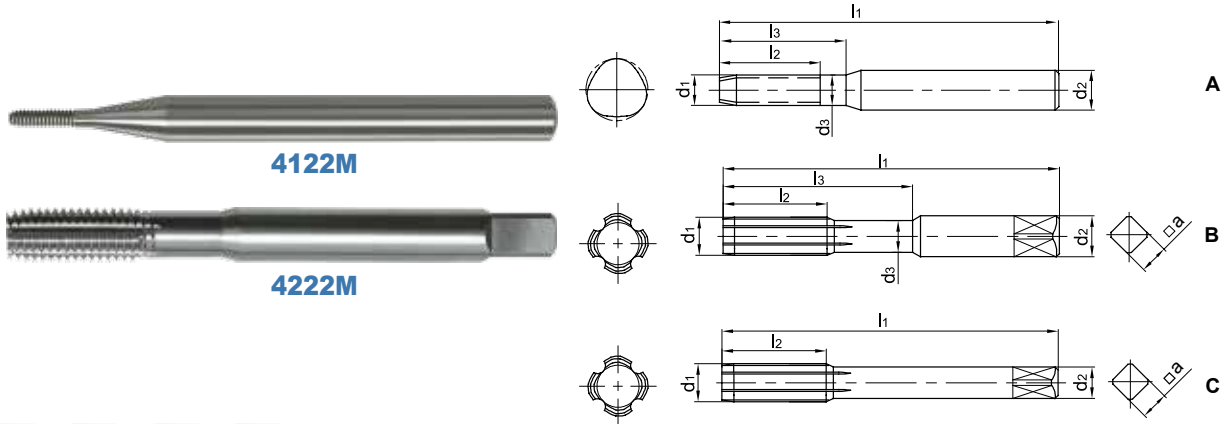

Type Typ	Cooling Kühlung	Basic dimension(mm) Basis Abmessungen											Number of teeth Zahne- anzahl	Grade Sorte		Coredrill Kernbohrer	
		Taper length Anschnitt- länge	d1	P	d2	d3	l1	l2	l3	a x a	Thread- profile Gewinde- profil	Geometry Ausführung		KTG402	YK40F		d
4122M-M1*0.25-6H	Extern	3P	M1	0.25	3		40	5				60°	A	4	●	○	0.9
4122MS-M1*0.25-6H	Extern	2P	M1	0.25	3		40	5				60°	A	4	●	○	0.9
4122M-M1.2*0.25-6H	Extern	3P	M1.2	0.25	3		40	5				60°	A	4	●	○	1.1
4122MS-M1.2*0.25-6H	Extern	2P	M1.2	0.25	3		40	5				60°	A	4	●	○	1.1
4122M-M1.6*0.35-6H	Extern	3P	M1.6	0.35	3	1.1	40	5	11			60°	A	4	●	○	1.47
4122MS-M1.6*0.35-6H	Extern	2P	M1.6	0.35	3	1.1	40	5	11			60°	A	4	●	○	1.47
4122M-M2*0.4-6H	Extern	3P	M2	0.4	3	1.5	45	6	12			60°	A	4	●	○	1.85
4122MS-M2*0.4-6H	Extern	2P	M2	0.4	3	1.5	45	6	12			60°	A	4	●	○	1.85
4122M-M2.5*0.45-6H	Extern	3P	M2.5	0.45	3	1.9	50	6	14			60°	A	4	●	○	2.33
4122MS-M2.5*0.45-6H	Extern	2P	M2.5	0.45	3	1.9	50	6	14			60°	A	4	●	○	2.33
4222M-M3*0.5-6H	Extern	3P	M3	0.5	3.5	2.3	56	6	18	2.7		60°	B	4	●	○	2.8
4222MS-M3*0.5-6H	Extern	2P	M3	0.5	3.5	2.3	56	6	18	2.7		60°	B	4	○	○	2.8
4222M-M4*0.5-6H	Extern	3P	M4	0.5	4.5	3.1	63	8	21	3.4		60°	B	4	●	○	3.8
4222MS-M4*0.5-6H	Extern	2P	M4	0.5	4.5	3.1	63	8	21	3.4		60°	B	4	●	○	3.8
4222M-M4*0.7-6H	Extern	3P	M4	0.7	4.5	3.1	63	8	21	3.4		60°	B	4	●	○	3.7
4222MS-M4*0.7-6H	Extern	2P	M4	0.7	4.5	3.1	63	8	21	3.4		60°	B	4	●	○	3.7
4222M-M5*0.5-6H	Extern	3P	M5	0.5	6	4.3	70	10	25	4.9		60°	B	4	●	○	4.8
4222MS-M5*0.5-6H	Extern	2P	M5	0.5	6	4.3	70	10	25	4.9		60°	B	4	●	○	4.8
4222M-M5*0.8-6H	Extern	3P	M5	0.8	6	4	70	10	25	4.9		60°	B	4	●	○	4.65
4222MS-M5*0.8-6H	Extern	2P	M5	0.8	6	4	70	10	25	4.9		60°	B	4	●	○	4.65
4222M-M6*0.75-6H	Extern	3P	M6	0.75	6	5	80	12	30	4.9		60°	B	4	●	○	5.7
4222MS-M6*0.75-6H	Extern	2P	M6	0.75	6	5	80	12	30	4.9		60°	B	4	●	○	5.7
4222M-M6*1-6H	Extern	3P	M6	1	6	4.7	80	12	30	4.9		60°	B	4	●	○	5.6
4222MS-M6*1-6H	Extern	2P	M6	1	6	4.7	80	12	30	4.9		60°	B	4	●	○	5.6
4222M-M7*1-6H	Extern	3P	M7	1	7	5.7	80	14	30	5.5		60°	B	4	●	○	6.6
4222MS-M7*1-6H	Extern	2P	M7	1	7	5.7	80	14	30	5.5		60°	B	4	●	○	6.6

● Ex Stock / ab Lager ○ On demand / auf Anfrage

Threading · Gewindebearbeitung

Solid carbide taps and cutter · Vollhartmetall-Gewindebohrer, -fräser

Type Typ	Cooling Kühlung	Basic dimension(mm) Basis Abmessungen											Number of teeth Zähne- anzahl	Grade Sorte		Coredrill Kernbohrer
		Taper length Anschlitt- länge	d ₁	P	d ₂	d ₃	l ₁	l ₂	l ₃	a×a	Thread- profile Gewinde- profil	Geometry Ausführung		KTG402	YK40F	
4222M-M8*1-6H	Extern	3P	M8	1	8	6.7	90	16	35	6.2	60°	B	4	●	○	7.6
4222MS-M8*1-6H	Extern	2P												●	○	
4222M-M8*1.25-6H	Extern	3P	M8	1.25	8	6.4	90	16	35	6.2	60°	B	4	●	○	7.45
4222MS-M8*1.25-6H	Extern	2P												●	○	
4222M-M10*1-6H	Extern	3P	M10	1	10	8.7	100	20	39	8	60°	B	5	●	○	9.6
4222MS-M10*1-6H	Extern	2P												●	○	
4222M-M10*1.25-6H	Extern	3P	M10	1.25	10	8.4	100	20	39	8	60°	B	5	●	○	9.45
4222MS-M10*1.25-6H	Extern	2P												●	○	
4222M-M10*1.5-6H	Extern	3P	M10	1.5	10	8.1	100	20	39	8	60°	B	5	●	○	9.35
4222MS-M10*1.5-6H	Extern	2P												●	○	
4222MC-M10*1.5-6H	Intern	3P												●	○	
4222MCS-M10*1.5-6H	Intern	2P												●	○	
4222M-M12*1.25-6H	Extern	3P	M12	1.25	9		110	24		7	60°	C	5	●	○	11.45
4222MS-M12*1.25-6H	Extern	2P												●	○	
4222M-M12*1.5-6H	Extern	3P	M12	1.5	9		110	24		7	60°	C	5	●	○	11.35
4222MS-M12*1.5-6H	Extern	2P												●	○	
4222M-M12*1.75-6H	Extern	3P	M12	1.75	9		110	24		7	60°	C	5	●	○	11.25
4222MS-M12*1.75-6H	Extern	2P												●	○	
4222MC-M12*1.75-6H	Intern	3P												●	○	
4222MCS-M12*1.75-6H	Intern	2P												●	○	
4222M-M14*1.5-6H	Extern	3P	M14	1.5	11		110	26		9	60°	C	6	●	○	13.35
4222MS-M14*1.5-6H	Extern	2P												●	○	
4222M-M14*2-6H	Extern	3P	M14	2	11		110	26		9	60°	C	6	●	○	13.1
4222MS-M14*2-6H	Extern	2P												●	○	
4222M-M16*1.5-6H	Extern	3P	M16	1.5	12		110	27		9	60°	C	6	●	○	15.35
4222MS-M16*1.5-6H	Extern	2P												●	○	
4222M-M16*2-6H	Extern	3P	M16	2	12		110	27		9	60°	C	6	○	○	15.1
4222MS-M16*2-6H	Extern	2P												●	○	
4222MC-M16*2-6H	Intern	3P												●	○	
4222MCS-M16*2-6H	Intern	2P												●	○	

Material Overview · Material Übersicht

✓ = Very suitable · Sehr empfohlen
 ✓ = Suitable · Empfohlen

Grade Sorte	Workpiece material · Werkstückstoff									
	Mild steel Baustahl HB≤180	Carbon steel Alloy Steel Kohlenstoff- Legierter Stahl	Hardened steel · Gehärteter Stahl			Stainless steel Rostfreier Stahl	Cast iron Gusseisen	Nodular cast iron GGG Kugelgra- phitguss	Aluminum alloy Aluleg.	Copper alloy Kupferleg.
KTG402	✓					✓				
YK40F	✓					✓		✓		

Code key C 155
ISO Kennzeichen

Cutting data C171
Schnittdaten

Technical Information C172-173
Technische Information.

Non-standard tailor made C174
Bestellformular für Sonderwerkzeuge

Threading - Gewindebearbeitung

Solid carbide taps and cutter ▪ Vollhartmetall-Gewindebohrer, -fräser

4201C

Tap for cast iron machining

Gewindebohrer zur Bearbeitung von Grauguss

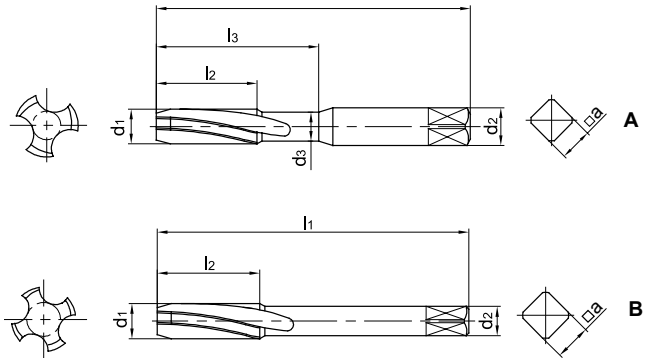

Type Typ	Taper length Anschnitt- länge	Basic dimension(mm) Basis Abmessungen										Number of teeth Zähne- anzahl	Grade Sorte YK40F	Coredrill Kernbohrer d
		d1	P	d2	d3	l1	l2	l3	a×a	Thread- profile Gewinde- profil	Geometry Ausführung			
4201C-M3*0.5-6H	3P	M3	0.5	3.5	2.3	56	11	18	2.7	60°	A	3	●	2.5
4201C-M3*0.5-6HX	3P												●	
4201CS-M3*0.5-6H	1.5P												●	
4201CS-M3*0.5-6HX	1.5P												●	
4201C-M4*0.7-6H	3P	M4	0.7	4.5	3.1	63	13	21	3.4	60°	A	3	●	3.3
4201C-M4*0.7-6HX	3P												●	
4201CS-M4*0.7-6H	1.5P												●	
4201CS-M4*0.7-6HX	1.5P												●	
4201C-M5*0.8-6H	3P	M5	0.8	6	4	70	16	25	4.9	60°	A	3	●	4.2
4201C-M5*0.8-6HX	3P												●	
4201CS-M5*0.8-6H	1.5P												●	
4201CS-M5*0.8-6HX	1.5P												●	
4201C-M6*0.75-6H	3P	M6	0.75	6	5	80	19	30	4.9	60°	A	3	●	5.25
4201C-M6*0.75-6HX	3P												●	
4201CS-M6*0.75-6H	1.5P												●	
4201CS-M6*0.75-6HX	1.5P												●	
4201C-M6*1-6H	3P	M6	1	6	4.7	80	19	30	4.9	60°	A	3	●	5
4201CC-M6*1-6H	3P												●	
4201C-M6*1-6HX	3P												●	
4201CS-M6*1-6H	1.5P												●	
4201CCS-M6*1-6H	1.5P												●	
4201CS-M6*1-6HX	1.5P												●	
4201C-M7*1-6H	3P	M7	1	7	5.7	80	19	30	5.5	60°	A	3	●	6
4201CS-M7*1-6H	1.5P												●	
4201C-M8*1-6H	3P	M8	1	8	6.7	90	20	35	6.2	60°	A	3	●	7
4201CS-M8*1-6H	1.5P												●	
4201C-M8*1.25-6H	3P	M8	1.25	8	6.4	90	22	35	6.2	60°	A	3	●	6.75
4201CC-M8*1.25-6H	3P												●	
4201C-M8*1.25-6HX	3P												●	
4201CS-M8*1.25-6H	1.5P												●	
4201CCS-M8*1.25-6H	1.5P												●	
4201CS-M8*1.25-6HX	1.5P												●	

● Ex Stock / ab Lager ○ On demand / auf Anfrage

Threading · Gewindebearbeitung

Solid carbide taps and cutter · Vollhartmetall-Gewindebohrer, -fräser

Type Typ	Basic dimension(mm) Basis Abmessungen											Number of teeth Zähne- anzahl	Grade Sorte YK40F	Coredrill Kernbohrer d
	Taper length Anschnitt- länge	d ₁	P	d ₂	d ₃	l ₁	l ₂	l ₃	a×a	Thread- profile Gewinde- profil	Geometry Ausführung			
4201C-M10*1-6H	3P	M10	1	10	8.7	100	20	39	8	60°	A	4	●	9
4201CS-M10*1-6H	1.5P												●	
4201C-M10*1.25-6H	3P	M10	1.25	10	8.4	100	24	39	8	60°	A	4	●	8.75
4201CS-M10*1.25-6H	1.5P												●	
4201C-M10*1.5-6H	3P	M10	1.5	10	8.1	100	24	39	8	60°	A	4	●	8.5
4201CC-M10*1.5-6H	3P												●	
4201C-M10*1.5-6HX	3P												●	
4201CS-M10*1.5-6H	1.5P												●	
4201CCS-M10*1.5-6H	1.5P												●	
4201CS-M10*1.5-6HX	1.5P												●	
4201C-M12*1.25-6H	3P	M12	1.25	9		110	29		7	60°	B	4	●	10.75
4201CS-M12*1.25-6H	1.5P												●	
4201C-M12*1.5-6H	3P	M12	1.5	9		110	29		7	60°	B	4	●	10.5
4201CS-M12*1.5-6H	1.5P												●	
4201C-M12*1.75-6H	3P	M12	1.75	9		110	29		7	60°	B	4	●	10.25
4201CC-M12*1.75-6H	3P												●	
4201C-M12*1.75-6HX	3P												●	
4201CS-M12*1.75-6H	1.5P												●	
4201CCS-M12*1.75-6H	1.5P												●	
4201CS-M12*1.75-6HX	1.5P												●	
4201C-M14*1.5-6H	3P	M14	1.5	11		110	30		9	60°	B	4	●	12.5
4201CS-M14*1.5-6H	1.5P												●	
4201C-M14*2-6H	3P	M14	2	11		110	30		9	60°	B	4	●	12
4201CS-M14*2-6H	1.5P												●	
4201C-M16*1.5-6H	3P	M16	1.5	12		110	32		9	60°	B	4	●	14.5
4201CS-M16*1.5-6H	1.5P												●	
4201C-M16*2-6H	3P	M16	2	12		110	32		9	60°	B	4	●	14
4201C-M16*2-6HX	3P												●	
4201CS-M16*2-6H	1.5P												●	
4201CS-M16*2-6HX	1.5P												●	

Material Overview · Material Übersicht

✓ = Very suitable · Sehr empfohlen
 ✓ = Suitable · Empfohlen

Grade Sorte	Workpiece material · Werkstückstoff									
	Mild steel Baustahl HB≤180	Carbon steel Alloy Steel Kohlenstoff-, Legierter Stahl	Hardened steel · Gehärteter Stahl			Stainless steel Rostfreier Stahl	Cast iron Gusseisen	Nodular cast iron GGG Kugelgra- phitguss	Aluminum alloy Aluleg.	Copper alloy Kupferleg.
YK40F			~40HRC	~50HRC	~60HRC		✓	✓		

Code key C 155
ISO Kennzeichen

Cutting data C171
Schnittdaten

Technical Information C172-173
Technische Information.

Non-standard tailor made C174
Bestellformular für Sonderwerkzeuge

Threading - Gewindebearbeitung

Solid carbide taps and cutter ▪ Vollhartmetall-Gewindebohrer, -fräser

4202C

Tap for cast iron machining

Gewindebohrer zur Bearbeitung von Grauguss

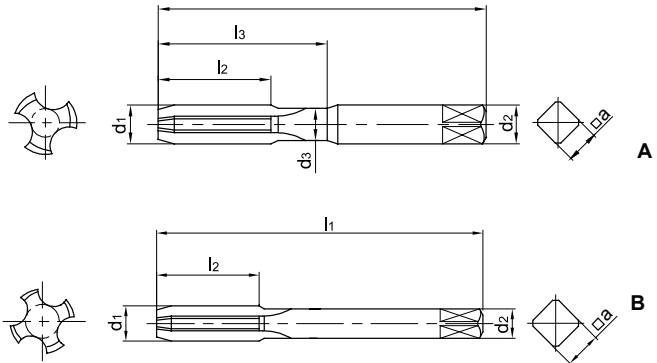

Type Typ	Basic dimension(mm) Basis Abmessungen											Number of teeth Zähne- anzahl	Grade Sorte YK40F	Coredrill Kernbohrer d
	Taper length Anschrittl- länge	d1	P	d2	d3	l1	l2	l3	a×a	Thread- profile Gewinde- profil	Geometry Ausführung			
4202C-M3*0.5-6H	3P	M3	0.5	3.5	2.3	56	11	18	2.7	60°	A	3	○	2.5
4202C-M3*0.5-6HX	3P												○	
4202CS-M3*0.5-6H	1.5P												○	
4202CS-M3*0.5-6HX	1.5P												○	
4202C-M4*0.7-6H	3P	M4	0.7	4.5	3.1	63	13	21	3.4	60°	A	3	●	3.3
4202C-M4*0.7-6HX	3P												●	
4202CS-M4*0.7-6H	1.5P												●	
4202CS-M4*0.7-6HX	1.5P												●	
4202C-M5*0.8-6H	3P	M5	0.8	6	4	70	16	25	4.9	60°	A	3	●	4.2
4202C-M5*0.8-6HX	3P												●	
4202CS-M5*0.8-6H	1.5P												●	
4202CS-M5*0.8-6HX	1.5P												●	
4202C-M6*0.75-6H	3P	M6	0.75	6	5	80	19	30	4.9	60°	A	3	○	5.25
4202C-M6*0.75-6HX	3P												○	
4202CS-M6*0.75-6H	1.5P												○	
4202CS-M6*0.75-6HX	1.5P												○	
4202C-M6*1-6H	3P	M6	1	6	4.7	80	19	30	4.9	60°	A	3	○	5
4202CC-M6*1-6H	3P												○	
4202C-M6*1-6HX	3P												○	
4202CS-M6*1-6H	1.5P												○	
4202CCS-M6*1-6H	1.5P												○	
4202CS-M6*1-6HX	1.5P												○	
4202C-M7*1-6H	3P	M7	1	7	5.7	80	19	30	5.5	60°	A	3	●	6
4202CS-M7*1-6H	1.5P												●	
4202C-M8*1-6H	3P	M8	1	8	6.7	90	20	35	6.2	60°	A	3	●	7
4202CS-M8*1-6H	1.5P												●	
4202C-M8*1.25-6H	3P	M8	1.25	8	6.4	90	22	35	6.2	60°	A	3	○	6.75
4202CC-M8*1.25-6H	3P												○	
4202C-M8*1.25-6HX	3P												○	
4202CS-M8*1.25-6H	1.5P												○	
4202CCS-M8*1.25-6H	1.5P												○	
4202CS-M8*1.25-6HX	1.5P												○	

● Ex Stock / ab Lager ○ On demand / auf Anfrage

Threading · Gewindebearbeitung

Solid carbide taps and cutter · Vollhartmetall-Gewindebohrer, -fräser

Type Typ	Basic dimension(mm) Basis Abmessungen											Number of teeth Zähne- anzahl	Grade Sorte YK40F	Coredrill Kernbohrer d
	Taper length Anschnit- länge	d ₁	P	d ₂	d ₃	l ₁	l ₂	l ₃	a×a	Thread- profile Gewinde- profil	Geometry Ausführung			
4202C-M10*1-6H	3P	M10	1	10	8.7	100	20	39	8	60°	A	4	●	9
4202CS-M10*1-6H	1.5P												●	
4202C-M10*1.25-6H	3P	M10	1.25	10	8.4	100	24	39	8	60°	A	4	●	8.75
4202CS-M10*1.25-6H	1.5P												●	
4202C-M10*1.5-6H	3P	M10	1.5	10	8.1	100	24	39	8	60°	A	4	●	8.5
4202CC-M10*1.5-6H	3P												●	
4202C-M10*1.5-6HX	3P												●	
4202CS-M10*1.5-6H	1.5P												●	
4202CCS-M10*1.5-6H	1.5P												●	
4202CS-M10*1.5-6HX	1.5P	●												
4202C-M12*1.25-6H	3P	M12	1.25	9		110	29		7	60°	B	4	●	10.75
4202CS-M12*1.25-6H	1.5P												●	
4202C-M12*1.5-6H	3P	M12	1.5	9		110	29		7	60°	B	4	●	10.5
4202CS-M12*1.5-6H	1.5P												●	
4202C-M12*1.75-6H	3P	M12	1.75	9		110	29		7	60°	B	4	○	10.25
4202CC-M12*1.75-6H	3P												○	
4202C-M12*1.75-6HX	3P												○	
4202CS-M12*1.75-6H	1.5P												○	
4202CCS-M12*1.75-6H	1.5P												○	
4202CS-M12*1.75-6HX	1.5P												○	
4202C-M14*1.5-6H	3P	M14	1.5	11		110	30		9	60°	B	4	●	12.5
4202CS-M14*1.5-6H	1.5P												●	
4202C-M14*2-6H	3P	M14	2	11		110	30		9	60°	B	4	●	12
4202CS-M14*2-6H	1.5P												●	
4202C-M16*1.5-6H	3P	M16	1.5	12		110	32		9	60°	B	4	●	14.5
4202CS-M16*1.5-6H	1.5P												●	
4202C-M16*2-6H	3P	M16	2	12		110	32		9	60°	B	4	●	14
4202C-M16*2-6HX	3P												●	
4202CS-M16*2-6H	1.5P												●	
4202CS-M16*2-6HX	1.5P												●	

Material Overview · Material Übersicht

✓ = Very suitable · Sehr empfohlen
 ✓ = Suitable · Empfohlen

Grade Sorte	Workpiece material · Werkstückstoff									
	Mild steel Baustahl HB≤180	Carbon steel Alloy Steel Kohlenstoff- Legierter Stahl	Hardened steel · Gehärteter Stahl			Stainless steel Rostfreier Stahl	Cast iron Gusseisen	Nodular cast iron GGG Kugelgra- phitguss	Aluminum alloy Aluleg.	Copper alloy Kupferleg.
YK40F							✓	✓		

Code key C 155
ISO Kennzeichen

Cutting data C171
Schnittdaten

Technical Information C172-173
Technische Information.

Non-standard tailor made C174
Bestellformular für Sonderwerkzeuge

Threading · Gewindebearbeitung

Solid carbide taps and cutter · Vollhartmetall-Gewindebohrer, -fräser

4201A

Tap for aluminum alloy machining

Gewindebohrer zur Bearbeitung von Aluminiumlegierungen

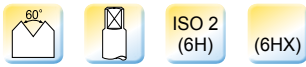
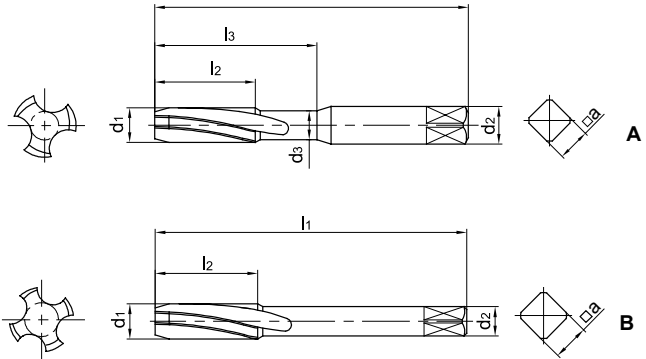

Type Typ	Basic dimension(mm) Basis Abmessungen											Number of teeth Zähne- anzahl	Grade Sorte YK40F	Coredrill Kernbohrer d
	Taper length Anschnitt- länge	d1	P	d2	d3	l1	l2	l3	a×a	Thread- profile Gewinde- profil	Geometry Ausführung			
4201A-M3*0.5-6H	3P	M3	0.5	3.5	2.3	56	11	18	2.7	60°	A	3	●	2.5
4201A-M3*0.5-6HX	3P												●	
4201AS-M3*0.5-6H	1.5P												●	
4201AS-M3*0.5-6HX	1.5P												●	
4201A-M4*0.7-6H	3P	M4	0.7	4.5	3.1	63	13	21	3.4	60°	A	3	●	3.3
4201A-M4*0.7-6HX	3P												●	
4201AS-M4*0.7-6H	1.5P												●	
4201AS-M4*0.7-6HX	1.5P												●	
4201A-M5*0.8-6H	3P	M5	0.8	6	4	70	16	25	4.9	60°	A	3	●	4.2
4201A-M5*0.8-6HX	3P												●	
4201AS-M5*0.8-6H	1.5P												●	
4201AS-M5*0.8-6HX	1.5P												●	
4201A-M6*0.75-6H	3P	M6	0.75	6	5	80	19	30	4.9	60°	A	3	●	5.25
4201A-M6*0.75-6HX	3P												●	
4201AS-M6*0.75-6H	1.5P												●	
4201AS-M6*0.75-6HX	1.5P												●	
4201A-M6*1-6H	3P	M6	1	6	4.7	80	19	30	4.9	60°	A	3	●	5
4201AC-M6*1-6H	3P												●	
4201A-M6*1-6HX	3P												●	
4201AS-M6*1-6H	1.5P												●	
4201ACS-M6*1-6H	1.5P												●	
4201AS-M6*1-6HX	1.5P												●	
4201A-M7*1-6H	3P	M7	1	7	5.7	80	19	30	5.5	60°	A	3	●	6
4201AS-M7*1-6H	1.5P												●	
4201A-M8*1-6H	3P	M8	1	8	6.7	90	20	35	6.2	60°	A	3	●	7
4201AS-M8*1-6H	1.5P												●	

● Ex Stock / ab Lager ○ On demand / auf Anfrage

C

Solid carbide drills
Vollhartmetallbohrer

Threading · Gewindebearbeitung

Solid carbide taps and cutter · Vollhartmetall-Gewindebohrer, -fräser

Type Typ	Basic dimension(mm) Basis Abmessungen											Number of teeth Zähne- anzahl	Grade Sorte	Coredrill Kernbohrer										
	Taper length Anschmitt- länge	d ₁	P	d ₂	d ₃	l ₁	l ₂	l ₃	a×a	Thread- profile Gewinde- profil	Geometry Ausführung		YK40F		d									
4201A-M8*1.25-6H	3P	M8	1.25	8	6.4	90	22	35	6.2	60°	A	3	●	6.75										
4201AC-M8*1.25-6H	3P												●											
4201A-M8*1.25-6HX	3P												●											
4201AS-M8*1.25-6H	1.5P												●											
4201ACS-M8*1.25-6H	1.5P												●											
4201AS-M8*1.25-6HX	1.5P												●											
4201A-M10*1-6H	3P	M10	1	10	8.7	100	20	39	8	60°	A	4	●	9										
4201AS-M10*1-6H	1.5P												●											
4201A-M10*1.25-6H	3P	M10	1.25	10	8.4	100	24	39	8	60°	A	4	●	8.75										
4201AS-M10*1.25-6H	1.5P												●											
4201A-M10*1.5-6H	3P												●											
4201AC-M10*1.5-6H	3P												●											
4201A-M10*1.5-6HX	3P												●											
4201AS-M10*1.5-6H	1.5P												●											
4201ACS-M10*1.5-6H	1.5P	M10	1.5	10	8.1	100	24	39	8	60°	A	4	●	8.5										
4201AS-M10*1.5-6H	1.5P												●											
4201ACS-M10*1.5-6H	1.5P												●											
4201AS-M10*1.5-6HX	1.5P												●											
4201A-M12*1.25-6H	3P												M12		1.25	9	110	29	7	60°	B	4	●	10.75
4201AS-M12*1.25-6H	1.5P																						●	
4201A-M12*1.5-6H	3P	M12	1.5	9	110	29	7	60°	B	4	●	10.5												
4201AS-M12*1.5-6H	1.5P										●													
4201A-M12*1.75-6H	3P	M12	1.75	9	110	29	7	60°	B	4	●	10.25												
4201AC-M12*1.75-6H	3P										●													
4201A-M12*1.75-6HX	3P										●													
4201AS-M12*1.75-6H	1.5P										●													
4201ACS-M12*1.75-6H	1.5P										●													
4201AS-M12*1.75-6HX	1.5P										●													
4201A-M14*1.5-6H	3P	M14	1.5	11	110	30	9	60°	B	4	●	12.5												
4201AS-M14*1.5-6H	1.5P										●													
4201A-M14*2-6H	3P	M14	2	11	110	30	9	60°	B	4	●	12												
4201AS-M14*2-6H	1.5P										●													
4201A-M16*1.5-6H	3P	M16	1.5	12	110	32	9	60°	B	4	●	14.5												
4201AS-M16*1.5-6H	1.5P										●													
4201A-M16*2-6H	3P	M16	2	12	110	32	9	60°	B	4	●	14												
4201A-M16*2-6HX	3P										●													
4201AS-M16*2-6H	1.5P										●													
4201AS-M16*2-6HX	1.5P										●													

Material Overview · Material Übersicht

✓ = Very suitable · Sehr empfohlen
 ✓ = Suitable · Empfohlen

Grade Sorte	Workpiece material · Werkstückstoff									
	Mild steel Baustahl HB≤180	Carbon steel Alloy Steel Kohlenstoff- Legierter Stahl	Hardened steel · Gehärteter Stahl			Stainless steel Rostfreier Stahl	Cast iron Gusseisen	Nodular cast iron GGG Kugelgra- phitguss	Aluminum alloy Aluleg.	Copper alloy Kupferleg.
YK40F									✓	

Code key C 155
ISO Kennzeichen

Cutting data C171
Schnittdaten

Technical Information C172-173
Technische Information.

Non-standard tailor made C174
Bestellformular für Sonderwerkzeuge

Threading - Gewindebearbeitung

Solid carbide taps and cutter ▪ Vollhartmetall-Gewindebohrer, -fräser

4202A

Tap for aluminum alloy machining

Gewindebohrer zur Bearbeitung von Aluminiumlegierungen

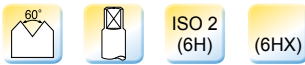
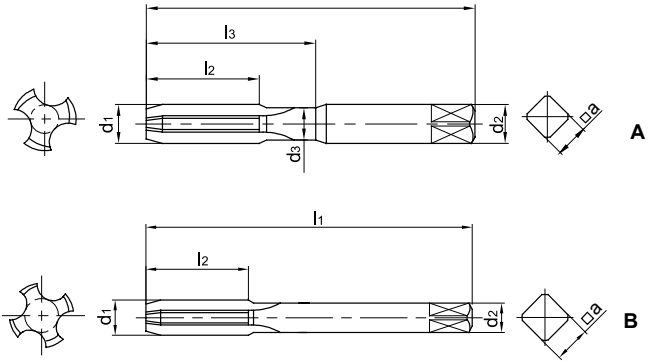

Type Typ	Taper length Anschnittlänge	Basic dimension(mm) Basis Abmessungen										Number of teeth Zähneanzahl	Grade Sorte	Coredrill Kernbohrer
		d1	P	d2	d3	l1	l2	l3	a×a	Thread-profile Gewindeprofil	Geometry Ausführung		YK40F	
4202A-M3*0.5-6H	3P	M3	0.5	3.5	2.3	56	11	18	2.7	60°	A	3	○	2.5
4202A-M3*0.5-6HX	3P												○	
4202AS-M3*0.5-6H	1.5P												○	
4202AS-M3*0.5-6HX	1.5P												○	
4202A-M4*0.7-6H	3P	M4	0.7	4.5	3.1	63	13	21	3.4	60°	A	3	○	3.3
4202A-M4*0.7-6HX	3P												○	
4202AS-M4*0.7-6H	1.5P												○	
4202AS-M4*0.7-6HX	1.5P												○	
4202A-M5*0.8-6H	3P	M5	0.8	6	4	70	16	25	4.9	60°	A	3	○	4.2
4202A-M5*0.8-6HX	3P												○	
4202AS-M5*0.8-6H	1.5P												○	
4202AS-M5*0.8-6HX	1.5P												○	
4202A-M6*0.75-6H	3P	M6	0.75	6	5	80	19	30	4.9	60°	A	3	○	5.25
4202A-M6*0.75-6HX	3P												○	
4202AS-M6*0.75-6H	1.5P												○	
4202AS-M6*0.75-6HX	1.5P												○	
4202A-M6*1-6H	3P	M6	1	6	4.7	80	19	30	4.9	60°	A	3	○	5
4202AC-M6*1-6H	3P												○	
4202A-M6*1-6HX	3P												○	
4202AS-M6*1-6H	1.5P												○	
4202ACS-M6*1-6H	1.5P												○	
4202AS-M6*1-6HX	1.5P												○	
4202A-M7*1-6H	3P	M7	1	7	5.7	80	19	30	5.5	60°	A	3	●	6
4202AS-M7*1-6H	1.5P												●	
4202A-M8*1-6H	3P	M8	1	8	6.7	90	20	35	6.2	60°	A	3	●	7
4202AS-M8*1-6H	1.5P												●	

● Ex Stock / ab Lager ○ On demand / auf Anfrage

C

Solid carbide drills
Vollhartmetallbohrer

Threading · Gewindebearbeitung

Solid carbide taps and cutter · Vollhartmetall-Gewindebohrer, -fräser

Type Typ	Basic dimension(mm) Basis Abmessungen											Number of teeth Zähne- anzahl	Grade Sorte	Coredrill Kernbohrer
	Taper length Anschnitt- länge	d ₁	P	d ₂	d ₃	l ₁	l ₂	l ₃	a×a	Thread- profile Gewinde- profil	Geometry Ausführung		YK40F	
4202A-M8*1.25-6H	3P	M8	1.25	8	6.4	90	22	35	6.2	60°	A	3	○	6.75
4202AC-M8*1.25-6H	3P												○	
4202A-M8*1.25-6HX	3P												○	
4202AS-M8*1.25-6H	1.5P												○	
4202ACS-M8*1.25-6H	1.5P												○	
4202AS-M8*1.25-6HX	1.5P												○	
4202A-M10*1-6H	3P	M10	1	10	8.7	100	20	39	8	60°	A	4	●	9
4202AS-M10*1-6H	1.5P												●	
4202A-M10*1.25-6H	3P	M10	1.25	10	8.4	100	24	39	8	60°	A	4	●	8.75
4202AS-M10*1.25-6H	1.5P												●	
4202A-M10*1.5-6H	3P												●	
4202AC-M10*1.5-6H	3P												●	
4202A-M10*1.5-6HX	3P												●	
4202AS-M10*1.5-6H	1.5P												●	
4202ACS-M10*1.5-6H	1.5P	●												
4202AS-M10*1.5-6HX	1.5P	●												
4202A-M12*1.25-6H	3P	M12	1.25	9		110	29		7	60°	B	4	●	10.75
4202AS-M12*1.25-6H	1.5P												●	
4202A-M12*1.5-6H	3P	M12	1.5	9		110	29		7	60°	B	4	●	10.5
4202AS-M12*1.5-6H	1.5P												●	
4202A-M12*1.75-6H	3P												●	
4202AC-M12*1.75-6H	3P												●	
4202A-M12*1.75-6HX	3P												●	
4202AS-M12*1.75-6H	1.5P												●	
4202ACS-M12*1.75-6H	1.5P	●												
4202AS-M12*1.75-6HX	1.5P	●												
4202A-M14*1.5-6H	3P	M14	1.5	11		110	30		9	60°	B	4	●	12.5
4202AS-M14*1.5-6H	1.5P												●	
4202A-M14*2-6H	3P	M14	2	11		110	30		9	60°	B	4	●	12
4202AS-M14*2-6H	1.5P												●	
4202A-M16*1.5-6H	3P	M16	1.5	12		110	32		9	60°	B	4	●	14.5
4202AS-M16*1.5-6H	1.5P												●	
4202A-M16*2-6H	3P	M16	2	12		110	32		9	60°	B	4	●	14
4202A-M16*2-6HX	3P												●	
4202AS-M16*2-6H	1.5P												●	
4202AS-M16*2-6HX	1.5P												●	

Material Overview · Material Übersicht

✓ = Very suitable · Sehr empfohlen
 ✓ = Suitable · Empfohlen

Grade Sorte	Workpiece material · Werkstückstoff									
	Mild steel Baustahl HB≤180	Carbon steel Alloy Steel Kohlenstoff- Legierter Stahl	Hardened steel · Gehärteter Stahl			Stainless steel Rostfreier Stahl	Cast iron Gusseisen	Nodular cast iron GGG Kugelgra- phitguss	Aluminum alloy Aluleg.	Copper alloy Kupferleg.
YK40F									✓	

Code key C 155
ISO Kennzeichen

Cutting data C171
Schnittdaten

Technical Information C172-173
Technische Information.

Non-standard tailor made C174
Bestellformular für Sonderwerkzeuge

Thread milling Cutter VHM Gewindefräser



Threading · Gewindebearbeitung

Solid carbide taps and cutter · Vollhartmetall-Gewindebohrer, -fräser

4111

Thread milling cutter with straight shank Gewindefräser mit Zylinderschaft

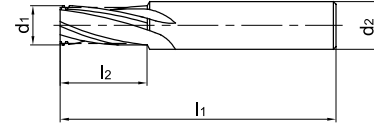

Type Typ	Basic dimension (mm) Basis Abmessungen						Number of teeth Zähnezahl	Grade Sorte		Coredrill Kernbohrer d
	D	d ₁	P	d ₂	l ₁	l ₂		KTG4015	YK40F	
4111-M3*0.5	M3	2.35	0.5	4	50	6	3	●	○	2.5
4111-M4*0.7	M4	3.15	0.7	4	50	8	3	●	○	3.3
4111-M5*0.5	M5	4.3	0.5	6	50	10	3	●	○	4.5
4111-M5*0.8	M5	4	0.8	6	50	10	3	●	○	4.2
4111-M6*0.75	M6	5	0.75	6	60	12	4	●	○	5.25
4111-M6*1	M6	4.75	1	6	60	12	4	●	○	5
4111-M8*1	M8	6.65	1	8	60	16	4	●	○	7
4111-M8*1.25	M8	6.45	1.25	8	60	16	4	●	●	6.75
4111-M10*1	M10	8.55	1	10	75	20	4	●	○	9
4111-M10*1.5	M10	8.1	1.5	10	75	20	4	●	○	8.5
4111-M12*1.25	M12	10.25	1.25	12	75	24	4	●	○	10.75
4111-M12*1.75	M12	9.75	1.75	12	75	24	4	●	○	10.25
4111-M14*1	M14	12.35	1	14	75	20	4	●	○	13
4111-M14*1.5	M14	11.9	1.5	14	75	28	4	●	○	12.5
4111-M14*2	M14	11.4	2	14	75	28	4	●	○	12
4111-M16*2	M16	13.3	2	16	90	32	6	●	○	14
4111-M18*1	M18	16.15	1	18	90	20	6	●	○	17
4111-M18*2.5	M18	14.75	2.5	18	90	36	6	●	○	15.5
4111-M20*2	M20	17.1	2	18	100	40	6	●	○	18
4111-M20*2.5	M20	16.65	2.5	18	100	40	6	●	○	17.5

● Ex Stock / ab Lager ○ On demand / auf Anfrage

Material Overview · Material Übersicht

✓ = Very suitable · Sehr empfohlen
 ✓ = Suitable · Empfohlen

Grade Sorte	Workpiece material · Werkstückstoff									
	Mild steel Baustahl HB≤180	Carbon steel Alloy Steel Kohlenstoff-, Legierter Stahl	Hardened steel · Gehärteter Stahl			Stainless steel Rostfreier Stahl	Cast iron Gusseisen	Nodular cast iron GGG Kugelgra- phitguss	Aluminum alloy Aluleg.	Copper alloy Kupferleg.
KTG4015	✓	✓	✓				✓	✓		
YK40F							✓		✓	✓

Code key C 155
ISO Kennzeichen

Cutting data C171
Schnittdaten

Technical Information C172-173
Technische Information.

Non-standard tailor made C174
Bestellformular für Sonderwerkzeuge



Solid carbide drills
Vollhartmetallbohrer

Threading - Gewindebearbeitung

Solid carbide taps and cutter ▪ Vollhartmetall-Gewindebohrer, -fräser

Thread milling cutter with straight shank Gewindefräser mit Zylinderschaft

Machine example Bearbeitungsbeispiel

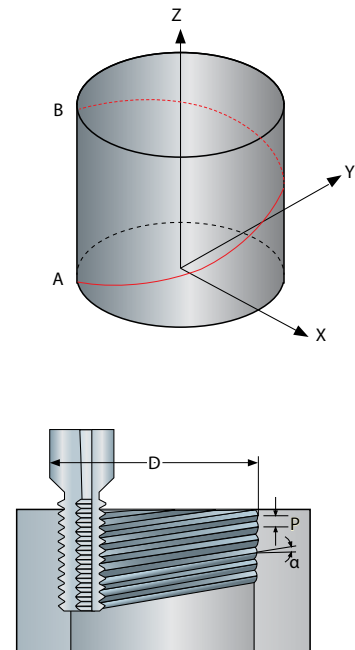
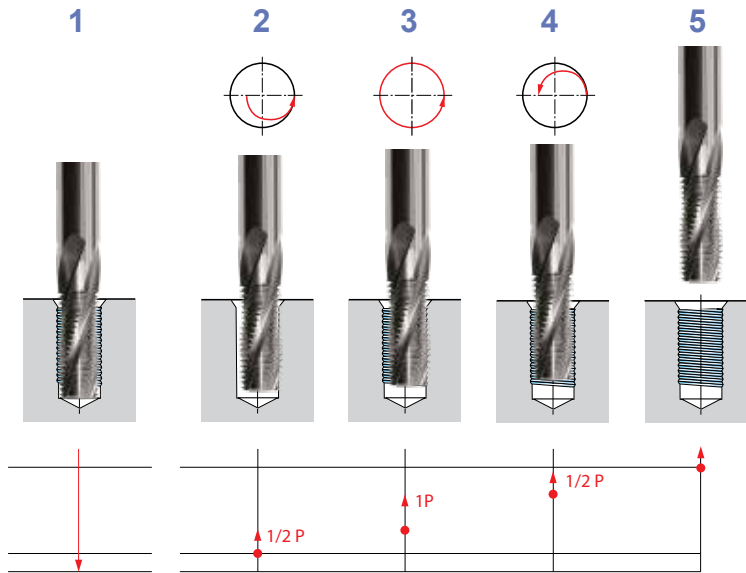

α : helix angle α : Steigungswinkel
D: diameter D: Durchmesser
p: pitch p: Steigung

Thread milling with circular cutting Gewindeherstellung durch Zirkularfräsen

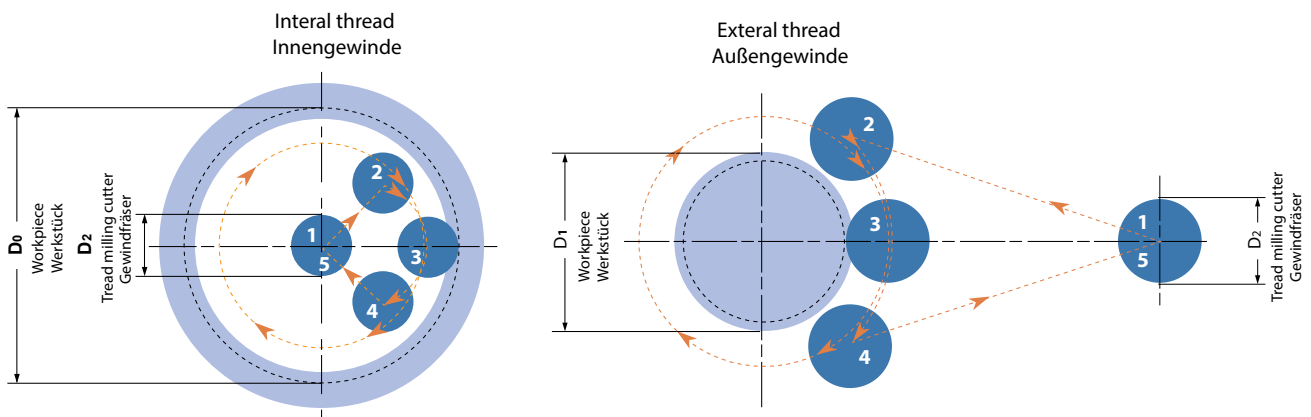

- 1: Positioning centered on start position
- 2: Movement to thread milling start position
- 3: 360° thread milling cycle with axial movement of the thread pitch in Z-direction
- 4: Linear withdrawal movement, end of thread milling
- 5: Return to start position

- 1: Werkzeug auf Mittelachse in die Bohrung auf Gewindetiefe einfahren
- 2: Eintauchen in die Kreisbahn über einen tangierenden Bogen
- 3: Vorschub um die Steigung mit rotierendem Werkzeug um die Mittelachse des Gewindes
- 4: Tangentiales Wegfahren aus der Kreisbahn
- 5: Rückzug auf Sicherheitsebene

C

Solid carbide drills
Vollhartmetallbohrer

Threading · Gewindebearbeitung

Solid carbide taps and cutter · Vollhartmetall-Gewindebohrer, -fräser

Thread forming tap · Gewindeformer

Tap drill · Gewindebohrer

Workpiece material Werkstückstoff	Cutting speed (m/min) · Schnittgeschwindigkeit			
	4201C	4202C	4201A	4202A 4122A 4222A
	YK40F	KTG402	YK40F	
Grey cast iron Grauguss	15-20	20-30	---	
Nodular cast iron GGG Kugelgraphitguss	10-15	15-20	---	
Aluminum alloy Alulegierung	---	---	20-25	
Casting aluminium alloy ≤Si10% gegossene Alulegierung	---	---	15-40	
Casting aluminium alloy ≥Si10% gegossene Alulegierung	---	---	---	

1. Threading is a complex machining, suitable coolant must be used. Using oil coolant is recommended for the cutting conditions above.
2. The table above is a general selecting standard, change it according to various cutting conditions.
3. Please adjust the cutting parameter appropriately according to system rigidity.

1. Beim Gewindeschneiden muss unbedingt Kühlmittel eingesetzt werden. Die obigen Schnittdaten basieren auf dem Einsatz von Öl.
2. In der obigen Tabelle sind Standarddaten angegeben.
3. Die Schnittdaten sollten entsprechend der Bearbeitung und Stabilität angepasst werden.

4111 Threading milling cutter · Gewindefräser

Workpiece material Werkstückstoff	carbon steel Kohlenstoffstahl ~750N/mm ²		alloy steel Leg. Stahl ~30HRC		Cast iron, Nodular cast iron GGG Grauguss, Kugelgraphitguss		Aluminum alloy Alulegierung		casting aluminium alloy gegossene Alulegierung			
	40~80m/min		20~40m/min		40~70m/min		40~80m/min		≤Si 10%		≥Si 10%	
Cutting speed Schnittgeschw.	40~80m/min		20~40m/min		40~70m/min		40~80m/min		60~140m/min		60~130m/min	
Diameter Durchmesser Ø (mm)	Rotating speed Drehzahl (min-1)	Feed rate per tooth Vorschub pro Zahn (mm/z)	Rotating speed Drehzahl (min-1)	Feed rate per tooth Vorschub pro Zahn (mm/z)	Rotating speed Drehzahl (min-1)	Feed rate per tooth Vorschub pro Zahn (mm/z)	Rotating speed Drehzahl (min-1)	Feed rate per tooth Vorschub pro Zahn (mm/z)	Rotating speed Drehzahl (min-1)	Feed rate per tooth Vorschub pro Zahn (mm/z)	Rotating speed Drehzahl (min-1)	Feed rate per tooth Vorschub pro Zahn (mm/z)
M5	5300	0.01~0.11	2800	0.01~0.03	5300	0.03~0.10	5300	0.03~0.10	8400	0.03~0.13	7500	0.03~0.10
M6	4800	0.01~0.11	2400	0.01~0.03	4800	0.03~0.10	4800	0.03~0.10	8000	0.03~0.13	7200	0.03~0.10
M8	3850	0.01~0.11	1900	0.01~0.03	3850	0.03~0.10	3850	0.03~0.10	6400	0.03~0.13	5700	0.03~0.10
M10	3200	0.01~0.11	1600	0.01~0.03	3200	0.03~0.10	3200	0.03~0.10	5300	0.03~0.13	4800	0.03~0.10
M12	2400	0.01~0.11	1200	0.01~0.03	2400	0.03~0.10	2400	0.03~0.10	4000	0.03~0.13	3600	0.03~0.10
M16	1900	0.01~0.11	960	0.01~0.03	1900	0.03~0.10	1900	0.03~0.10	3200	0.03~0.13	2900	0.03~0.10
M20	1600	0.01~0.11	800	0.01~0.03	1600	0.03~0.10	1600	0.03~0.10	2650	0.03~0.13	2400	0.03~0.10

1. Water-soluble coolant is recommended for the cutting conditions above.
2. Please adjust the cutting parameter appropriately according to system rigidity.
3. The cutting conditions above is set on the basis of coated grade KTG4015. When use uncoated grade YK40F, please reduce the cutting speed and feed rate to the 50%~70% of speed stated above.

1. Bei den obigen Schnittdaten sollte Emulsion eingesetzt werden.
2. Die Schnittdaten sollten entsprechend der Bearbeitungsstabilität angepasst werden.
3. Die obigen Schnittdaten basieren auf dem Einsatz von VHM Gewindebohrern in der beschichteten. Sorte KTG4015. Beim Einsatz der unbeschichteten Hartmetallsorte YK40F sind die Schnittdaten, Schnittgeschwindigkeit und Vorschub um 50-70% zu reduzieren.



Threading · Gewindebearbeitung

Solid carbide taps and cutter · Vollhartmetall-Gewindebohrer, -fräser

Terminology of tap · Terminologie von Gewindebohrern

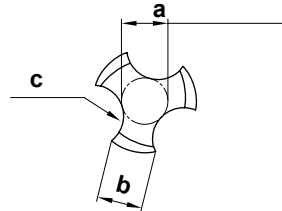
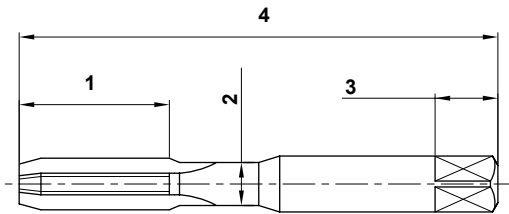

- | | |
|-------------------|---------------------|
| 1. Thread length | 1. Gewindelänge |
| 2. Neck diameter | 2. Hals Durchmesser |
| 3. Square length | 3. Schneidenlänge |
| 4. Overall length | 4. Gesamtlänge |

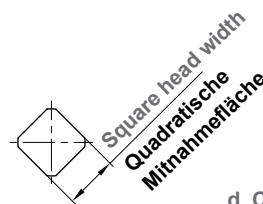
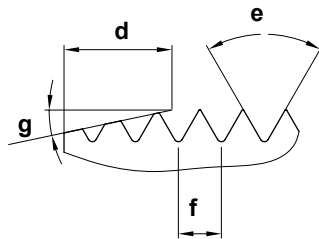

- | | |
|------------------|--------------------|
| a. Web thickness | a. Kerndurchmesser |
| b. Margin width | b. Schneidenstärke |
| c. Chip flute | c. Spanraum |

Magnifying chamfer and thread profile
Anschnitt und Gewindeprofil



- | | |
|-------------------------|------------------------|
| d. Chamfer length | d. Anschnittlänge |
| e. Thread profile angle | e. Gewindeprofilwinkel |
| f. Pitch | f. Steigung |
| g. Chamfer angle | g. Anschnittwinkel |

Different tap's chip flute and features · Spanraum und Anwendung

Type of chip flute Spanraum Typ	Feature Eigenschaften	Application Anwendung
<p>Helical flute tap Gedrahlte Spannutt</p> 	<ul style="list-style-type: none"> • Helical flute • Tap blind hole to its flat bottom • No chips remain • Good entering performance • Penetrate to pre-hole easily <ul style="list-style-type: none"> • spiralförmiger Spanraum • Für Sackloch geeignet • Keine Späne in Bohrung • Gute Ausschnittleistung • Einfache Zentrierung 	<ul style="list-style-type: none"> • Material generating long curled chips • Blind hole • The hole with axial slot on inner wall <ul style="list-style-type: none"> • Für langspanende Werkstoffe • Für Sackloch geeignet • Einsatz in Bohrungen mit Nute
<p>Straight flute tap Gerade Spannutt</p> 	<ul style="list-style-type: none"> • Straight flute • High cutting edge strength • Easy to regrind • Easy selection of chamfer length <ul style="list-style-type: none"> • gerade genuteter Spanraum • stabile Schneide • leicht nachzuschleifen • Leichte Auswahl (Ausschnitt) 	<ul style="list-style-type: none"> • For machining high hardness material • Material generating powdered form chips • Tap short through and blind hole • Material easy to generate wear <ul style="list-style-type: none"> • Für Hartbearbeitung • Zum Kurzspanen des Materials • Für Durchgangs- und Sackbohrungen • Für verschleißendes Material

C

Solid carbide drills
Vollhartmetallbohrer

What is thread forming? Was ist Gewindeformen?

The fiber orientation is not cut at the thread root but compressed. Thus, the formed threads are issued solid and have a very smooth surface. Higher speeds and feed rates compared to the cutting increase productivity.

- The thread is formed much more precise.
- The threads are stronger.
- Increased tool life increases productivity.

Reason for this is that there is no loss of material when tapping as opposed to cutting, the material instead remains fully obtained by forming.

Thread forms should be used in materials with good cold formability. These are in addition to steel and stainless steel light metals and light alloys with a yield strength of 1200 N / mm². Basically materials come into consideration, which are chipping long chips when drilling.

Die Materialfaser wird nicht durchtrennt, sondern am Gewindegrund verdichtet. Dadurch sind die geformten Gewinde auszugsfester und hat eine sehr glatte Oberfläche. Höhere Drehzahlen und Vorschubgeschwindigkeiten gegenüber dem Schneiden erhöht die Produktivität.

- Das Gewinde wird deutlich präziser ausgeformt.
- Die Gewinde sind belastbarer.
- Höhere Standzeit der Werkzeuge steigert die Produktivität.

Grund dafür ist, dass beim Gewindeformen im Gegensatz zum Schneiden kein Material verloren geht, sondern durch Umformen vollständig erhalten bleibt

Gewindeformen sollte in Materialien mit guter Kaltverformbarkeit eingesetzt werden. Dies sind neben Stahl und Edelstahl auch Leichtmetalle und Leichtmetall Legierungen mit einer Streckgrenze von 1200 N/mm². Grundsätzlich kommen Werkstoffe in Betracht, die beim Bohren langspanend sind.

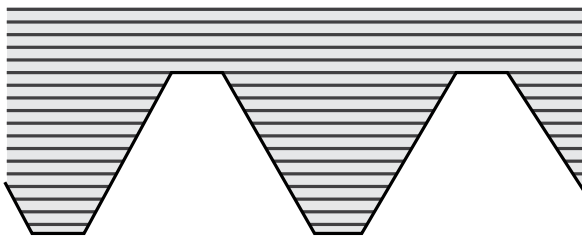

Fiber orientation after thread-cutting
Faserverlauf beim Gewindeschneiden

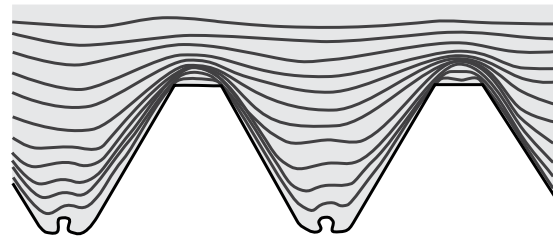

Fiber orientation after thread-forming
Faserverlauf beim Gewindeformen

Advantages of the method are: Vorteile des Verfahrens sind:

- No chips
- No material loss
- Higher tool life compared to the taps
- Higher processing speed
- Smoother material surface after machining
- High precision possible.
- Keine Späne
- Kein Materialverlust
- Höhere Standzeit als beim Gewindebohrer
- Höhere Bearbeitungsgeschwindigkeit
- Glattere Materialoberfläche nach der Bearbeitung
- Hohe Präzision möglich.

Disadvantages of the process are: Nachteile des Verfahrens sind:

- Higher requirement for the hole tolerance
- Use as a hand-tool rarely possible
- Higher heat than when drilling
- Many materials cannot be shaped
- Often the use of a release agent is needed.
- Höhere Anforderung an die Bohrlochtoleranzen
- Einsatz als Handwerkzeug schlecht möglich
- Höhere Wärmeentwicklung als beim Bohren
- Viele Materialien lassen sich nicht formen
- Oft ist der Einsatz eines Trennmittels notwendig.

The material is cold-formed and solidified in the molds. This increases the pullout strength of threads. Frequently taps are used in holes that have been produced by a thread former.

Das Material wird beim Formen kaltverformt und verfestigt. Dies erhöht die Auszugsfestigkeit von Gewinden. Häufig werden Gewindeformer bei Bohrungen eingesetzt, die mittels eines Fließformers hergestellt wurden.

Threading · Gewindebearbeitung

Solid carbide taps and cutter · Vollhartmetall-Gewindebohrer, -fräser

Non-standard Taylor made · Sonderwerkzeuge

<p>Name:</p> <p>Company / Firma:</p> <p>Fax:</p> <p>Tel:</p> <p>E-mail:</p>	 <p>Heltorfer Straße 12 40472 Düsseldorf Germany Fax: +49-(0)211-989240-111 E-Mail: info@zccct-europe.com</p>
---	--

Machining information and Workpiece Material · Bearbeitungsinfo und Werkstückstoff

Hole shape
Bohrungs-
ausführung

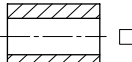
 Through-hole
Durchgangs-
bohrung

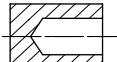
 Blind-hole
Sackbohrung

Taper length
Gewindelänge mm

Hole tolerance
Bohrungstoleranz

Status of hole
Werkstückzustand pre-drill
Vorbohren casting-mold hole
Gegossene oder
geschmiedete
Bohrung

- Grey cast iron
Grauguss
- Nodular cast iron GGG
Kugelgraphitguss
- Aluminium alloy
Alulegierung
- Si Al alloy Si<10%
Si-Alulegierung
- Si Al alloy Si 10%
Si-Alulegierung

Machined material trademark
Spezieller Werkstückstoff

Tensile Strength · Zugfestigkeit

 N/mm²

Hardness · Härte

Tool information · Werkzeug-Informationen

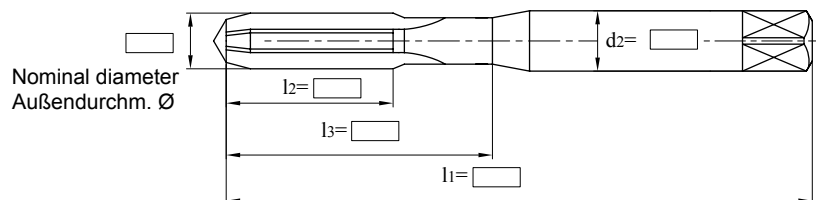

thread profil
Gewindeprofil

Thread angle = 60°
Gewindeginkel = 60°

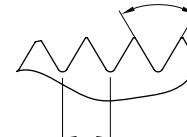

Pitch
Steigung

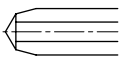
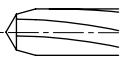
Tool rotating direction Drehrichtung	
<input type="checkbox"/>	
<input type="checkbox"/>	

Cooling / Kühlung
<input type="checkbox"/> External Extern
<input type="checkbox"/> Internal Intern

Coating Beschichtung
<input type="checkbox"/> Yes / Ja
<input type="checkbox"/> No / Nein

Remarks:
Bemerkungen:

Order quantity: pieces
Auftragsmenge: Stücke

Expected delivery date:
Gwünschtes Lieferdatum:

Date · Datum:

Confirmation · Unterschrift:



Solid carbide drills
Vollhartmetallbohrer

Threading pre-hole diameter · Kernlochdurchmesser

- Metric Coarse thread
- Metrisch - Gewinde

- Metric fine screw fine
- Metrisch - Feingewinde

Thread code Gewindebez.	Pre-hole diameter (mm) Kerndurchmesser
M3×0.5	2.5
M3.5×0.6	2.9
M4×0.7	3.3
M5×0.8	4.2
M6×1.0	5.0
M7×1.0	6.0
M8×1.25	6.75
M9×1.25	7.75
M10×1.5	8.5
M11×1.5	9.5
M12×1.75	10.25
M14×2.0	12.0
M16×2.0	14.0
M18×2.5	15.5
M20×2.5	17.5
M24×3.0	21.0
M27×3.0	24.0
M30×3.5	26.5

Thread code Gewindebez.	Pre-hole diameter (mm) Kerndurchmesser
M3×0.35	2.65
M3.5×0.35	3.15
M4×0.5	3.5
M4.5×0.5	4.0
M5×0.5	4.5
M5.5×0.5	5.0
M6×0.75	5.25
M7×0.75	6.25
M8×1.0	7.0
M8×0.75	7.25
M9×1.0	8.0
M9×0.75	8.25
M10×1.25	8.75
M10×1.0	9.0
M10×0.75	9.25
M11×1.0	10.0
M11×0.75	10.25
M12×1.5	10.5
M12×1.25	10.75
M12×1.0	11.0

Thread code Gewindebez.	Pre-hole diameter (mm) Kerndurchmesser
M14×1.5	12.5
M14×1.0	13.0
M15×1.5	13.5
M15×1.0	14.0
M16×1.5	14.5
M16×1.0	15.0
M17×1.5	15.5
M17×1.0	16.0
M18×2.0	16.0
M18×1.5	16.5
M18×1.0	17.0
M20×2.0	18.0
M20×1.5	18.5
M20×1.0	19.0
M22×2.0	20.0
M22×1.5	20.5
M22×1.0	21.0
M24×2.0	22.0
M24×1.5	22.5
M24×1.0	23.0

Surface roughness · Oberflächenrauigkeit

D

Technical Info
Technische Info

Type Typ	Code	Calculation method · Berechnungsmethode	Calculation example (figure) · Meßaufnahme (Abb.)
Arithmetic average deviation of profile Mittlere Rauhtiefe	Ra	<p>Within sampling length l, the arithmetic average absolute value of profile deviation is</p> $R_a = \frac{1}{l} \int_0^l y(x) dx$ <p>In the formula, the profile deviation y is the distance between profile points and reference line in the measuring direction. Reference line is the profile least-square average line O. This line divide the profile and make the sum of squares of profile deviation to be the minimum within the sampling length.</p> <p>Der Mittelrauhwert R_a ist der arithmetische Mittelwert der absoluten Beträge der Abstände y des Rauheitsprofils von der Mittellinie innerhalb der Messstrecke. Dies ist gleichbedeutend mit der Höhe des Rechtecks, dessen Länge gleich der Gesamtstrecke l ist und das flächengleich mit der Summe der zwischen dem Rauheitsprofil und der Mittellinie eingeschlossenen Fläche ist $y=f$</p>	
Irregularity ten-point high Gemittelte Rauhtiefe	Rz	<p>Within sampling length l, the sum of the average value of heights of five highest profile peak and the depths of five deepest profile valleys</p> $R_z = \frac{\sum_{i=1}^5 y_{pi} + \sum_{i=1}^5 y_{vi}}{5}$ <p>In the formula, y_{pi} means the height of 'i'th highest profile peak. In the formula, y_{vi} means the depth of 'i'th deepest profile valley.</p> <p>Maximum height of profile R_y: the distance between the top profile peak line and the bottom profile valley line in the longitudinal direction within the sampling length l.</p> <p>Die gemittelte Rauhtiefe R_z ist das arithmetische Mittel aus den Einzelrauhtiefen fünf aufeinander grenzender Einzelmessstrecken gleicher Länge. R_z wird ebenfalls in (μm) angegeben.</p>	
Maximum height of profile Maximale Rauhtiefe	Ry	<p>The distance between the inner profile peak line and the bottom profile valley line in the longitudinal direction within the sampling length l.</p> <p>Top profile peak line is the line that parallels to the reference line and passes through the highest point of profile peak.</p> <p>Bottom profile line is the line that parallels to the reference line and passes through the lowest point of profile valley.</p> <p>Die maximale Rauhtiefe R_y ist die größte der auf der Gesamtmeßstrecke l vorkommenden Einzelrauhtiefen, R_y wird auch in (μm) Mikrometer angegeben. (Bemerkung) Um R_z herausfinden, wird ein Anteil ohne außergewöhnliche Höhen und Tiefen als Stichprobenlänge ausgewählt und als Schwachstelle betrachtet.</p>	

General Technical Inform ▪ Allgemeine Technische Info

Material comparison table · Werkstoffe Vergleichstabelle

ISO	Country and Standard · Standardbezeichnung nach Länder											
	China	USA	Germany		Great Britain		Sweden	France	Italy	Spain	Japan	Russia
	GB	AISI/SAE	W.-nr	DIN	BS	EN	SS	AFNOR	UNI	UNE	JIS	GOST
P	Alloy steel · Legierter Stahl											
	15	1015	1.0401	C15	080M15	-	1350	CC12	C15C16	F.111	-	-
	20	1020	1.0402	C22	050A20	2C	1450	CC20	C20C21	F.112	-	20
	35	1035	1.0501	C35	060A35	-	1550	CC35	C35	F.113	-	35
	45	1045	1.0503	C45	080M40	-	1650	CC45	C45	F.114	-	45
	55	1055	1.0535	C55	070M55	-	1655	-	C55	-	-	55
	60	1060	1.0601	C60	080A62	43D	-	CC55	C60	-	-	60
	Y15	1213	1.7015	9SMn28	230M07	-	1912	S250	CF9SMn28	11SMn28	SUM22	15Ch
	-	12L13	1.0718	9SMnPb28	-	-	1914	S250Pb	CF9MnPb28	11SMnPb28	SUM22L	-
	-	-	1.0722	10SPb20	-	-	-	10PbF2	CF10Pb20	10SPb20	-	-
	-	1140	1.0726	35S20	212M36	8M	1957	35MF4	-	F210G	-	-
	Y13	1215	1.0736	9SMn36	240M07	1B	-	S300	CF9SMn36	12SMn35	-	-
	-	12L14	1.0737	9SMnPb36	-	-	1926	S300Pb	CF9SMnPb36	12SMnP35	-	-
	55Si2Mn	9255	1.0904	55Si9	250A53	45	2085	55S7	55Si8	56Si7	-	-
	-	9262	1.0961	60SiCr7	-	-	-	60SC7	60SiCr8	60SiCr8	-	-
	15	1015	1.1141	Ck15	080M15	32C	1370	XC12	C16	C15K	S15C	15
	40Mn	1039	1.1157	40Mn4	150M36	15	-	35M5	-	-	-	40G
	25	1025	1.1158	Ck25	-	-	-	-	-	-	S25C	25
	35Mn2	1335	1.1167	36Mn5	-	-	2120	40Mn5	-	36Mn5	SMn438(H)	35G2,35GL
	30Mn	1330	1.1170	28Mn6	150M28	14A	-	20M5	C28Mn	-	SCMn1	30G
	35Mn	1035	1.1183	Cf35	060A35	-	1572	XS38TS	C36	-	S35C	-
	Ck45	1045	1.1191	45	080M46	-	1672	XC42	C45	C45K	S45C	-
	55	1055	1.1203	Ck55	070M55	-	-	XC45	C50	C55K	S55C	55
	50	1050	1.1213	Cf53	060A52	-	1674	XC48TS	C53	-	S50C	-
	60Mn	1060	1.1221	Ck60	080A62	43D	1678	XC60	C60	-	S58C	60,60G
	-	1095	1.1274	Ck101	060A96	-	1870	-	-	-	SUP4	-
	-	-	1.3401	X120Mn12	Z120M12	-	-	X120M12	XG120Mn12	X120Mn12	SCMnH/1	110G13L
	Gr15;45Gr	52100	1.3505	100Cr6	534A99	31	2258	100C6	100Cr6	F.131	SUJ2	SchCh 15
	-	ASTM A204Gr.A	1.5415	15Mo3	1501-240	-	2912	15D3	16Mo3KW	16Mo3	-	-
	-	4520	1.5426	16Mo5	1503-245-420	-	-	-	16Mo5	16Mo5	-	-
-	ASTM A350LF5	1.5622	14Ni6	-	-	-	16N6	14Ni6	15Ni6	-	-	
-	ASTM A353	1.5662	X8Ni9	1501-509;510	-	-	-	X10Ni9	XBNI09	-	-	

D

Technical Info
Technische Info

General Technical Inform - Allgemeine Technische Info

Material comparison table · Werkstoffe Vergleichstabelle

ISO	Country and Standard · Standardbezeichnung nach Länder											
	China	USA	Germany		Great Britain		Sweden	France	Italy	Spain	Japan	Russia
	GB	AISI/SAE	W.-nr	DIN	BS	EN	SS	AFNOR	UNI	UNE	JIS	GOST
P	Alloy steel · Legierter Stahl											
	-	2515	1.5680	12Ni19	-	-	-	Z18N5	-	-	-	-
	-	3135	1.5710	36NiCr6	640A35	111A	-	35NC6	-	-	SNC236	-
	-	3415	1.5732	14NiCr10	-	-	-	14NC11	16NiCr11	15NiCr11	SNC415(H)	-
	-	3415 3310	1.5752	14NiCr14	655M13 655A12	36A	-	12NC15	-	-	SNC815(H)	-
	-	9840	1.6511	36CrNiMo4	816M40	110	-	40NCD3	38CrNiMo4(KB)	35CrNiMo4	-	40 ChN2MA
	-	8620	1.6523	21NiCrMo2	850M20	362	2503	20NCD2	20NiCrMo2	20NiCrMo2	SNCCM220(H)	-
	-	8740	1.6546	40NiCrMo2	311-Type7	-	-	-	40NiCrMo2(KB)	40NiCrMo2	SNC240	38ChGNM
	40CrNiMoA	4340	1.6582	34CrNiMo6	817M40	24	2541	35NCD6	35CrNiMo6(KB)	-	-	38Ch2N2MA
	-	-	1.6587	17CrNiMo6	820A16	-	-	18NCD6	-	14CrNiMo13	-	-
	15Cr	5015	1.7015	15Cr3	523M15	-	-	12C3	-	-	SCr415(H)	15Ch
	35Cr	5132	1.7033	34Cr4	530A32	18B	-	32C4	34Cr4(KB)	35Cr4	SCr430(H)	35Ch
	40Cr	5140	1.7035	41Cr4	530M40	18	-	42C4	41Cr4	42Cr4	SCr440(H)	40Ch
	40Cr	5140	1.7045	42Cr4	-	-	2245	-	-	42Cr4	SCr440	40Ch
	18CrMn	5115	1.7131	16MnCr15	(527M20)	-	2511	16MC5	16MnCr15	16MnCr15	-	18ChG
	20CrMn	5155	1.7176	55Cr3	527A60	48	-	55C3	-	-	SUP9(A)	50ChGA
	30CrMn	4130	1.7218	25CrMo4	1717CDS110	-	2225	25CD4	25CrMo4(KB)	55Cr3	SCM420; SCM430	30ChM
	35CrMo	4137;4135	1.7220	34CrMo4	708A37	19B	2234	35CD4	35CrMo4	34CrMo4	SCM432; SCRMM3	AS38ChGM
	40CrMoA	4140;4142	1.7223	41CrMo4	708M40	19A	2244	42CD4TS	41CrMo4	41CrMo4	SCM440	40 ChFA
	42CrMo 42CrMnMo	4140	1.7225	42CrMo4	708M40	19A	2244	42CD4	42CrMo4	42CrMo4	SCM440(H)	-
	-	-	1.7262	15CrMo5	-	-	2216	12CD4	-	12CrMo4	SCM415(H)	-
	-	ASTM A182 F11;F12	1.7335	13CrMo44	1501-620Gr.27	-	-	15CD3.5; 15CD4.5	14CrMo44	14CrMo45	-	12ChM , 15ChM
	-	-	1.7361	32CrMo12	722M24	40B	2240	30CD12	32CrMo12	F.124.A	-	-
	-	ASTM A182 F.22	1.7380	10CrMo910	1501- 622Gr.31;45	-	2218	12CD9;10	12CrMo9,10	TU.H	-	-
	-	-	1.7715	14MoV63	1503-660-440	-	-	-	-	13MoCrV6	-	-
	50CrVA	6150	1.8159	50CrV4	735A50	47	2230	50CV4	50CrV4	51CrV4	SUP10	50ChGFA
	-	-	1.8509	41CrAlMo7	905M39	41B	2940	40CAD6,12	41CrAlMo7	41CrAlMo7	-	38ChMJuA
	-	-	1.8523	39CrMoV139	897M39	40C	-	-	36CrMoV12	-	-	-

D

Technical Info
Technische Info

Material comparison table · Werkstoffe Vergleichstabelle

ISO	Country and Standard · Standardbezeichnung nach Länder											
	China	USA	Germany		Great Britain		Sweden	France	Italy	Spain	Japan	Russia
	GB	AISI/SAE	W.-nr	DIN	BS	EN	SS	AFNOR	UNI	UNE	JIS	GOST
P	Tool steel · Werkzeugstahl											
	T10	W.110	1.1545	C105W1	-	-	1880	Y1105	C98KU C100KU	F.515 F.516	-	U10A
	T12A	W.112	1.1663	C125W	-	-	-	Y2120	C120KU	(C120)	SK2	U13
	CrV;9SiCr	L3	1.2067	100Cr6	BL3	-	-	Y100C6	-	100Cr6	-	-
	Cr12	D3	1.2080	X210Cr12	BD3	-	-	Z200Cr12	X210Cr13KU X250Cr12KU	X210Cr12	SKD1	Ch12
	4Cr5MoVSi	H13	1.2344	X40CrMoV5 1	BH13	-	2242	Z40CDV5	X35CrMoV05KU X40CrMoV51KU	X40CrMoV5	SKD61	4Ch5MF1S
	Cr6WV	A2	1.2363	X100CrMoV5 1	BA2	-	2260	Z100CDV5	X100CrMoV51KU	X100CrMoV5	SKD12	-
	CrWMo	-	1.2419	105WCr6	-	-	2140	105WC13	10WCr6 107WCr5KU	105WCr5	SKS31 SKS2 SKS3	ChWG
	Cr12W	-	1.2436	X210CrW12	-	-	2312	-	X215CrW12 1KU	X210CrW12	SKD2	-
	5CrNiMo	S1	1.2542	45WCrV7	BS1	-	2710	-	45WCrV8KU	45WCrSi8	-	-
	3Cr2W8V	H21	1.2581	X30WCrV9 3 X30WCrV93KU	BH21	-	-	Z30WCV9	X28W09KU X30WCrV9 3KU	X30WCrV9	SKD5	3Ch2W8F
	Cr12MoV	-	1.2601	X165CrMoV 12	-	-	2310	-	X165CrMoV12KU	X160CrMoV12	SKD11	-
	5CrNiMo	L6	1.2713	55NiCrMoV6	-	-	-	55NCDV7	-	F.250.S	SKT4	5ChNM
	V	W210	1.2833	100V1	BW2	-	-	Y1105V	-	-	SKS43	-
	W6Mo5Cr4V2Co5	-	1.3243	S6-5-2-5	-	-	2723	Z85WDCV	HS6-5-2-5	HS6-5-2-5	SKH55	R6M5K5
	W18Cr4VCo5	T4	1.3255	S18-1-2-5	BT4	-	-	Z80WKCV 10-05-04-01	X78WCo1805KU	HS18-1-1-5	SKH3	-
	W6Mo5Cr4V2	M2	1.3343	S6-5-2	BM2	-	2722	Z85WDCV 06-05-04-02	X82WMo0605KU	HS6-5-2	SKH9	R6M5
	-	M7	1.3348	S2-9-2	-	-Z-	2782	Z100WCWV 09-02-04-02	HS2-9-2	HS2-9-2	-	-
	W18Cr4V	T1	1.3355	S18-0-1	BT1	-	-	Z80WCV 18-04-01	X75W18KU	HS18-0-1	SKH2	-
	W6Mo5Cr4V3	M3	-	S6-5-3	-	-	-	-	-	-	SKH52	-
-	M42	-	-	BM42	-	-	-	-	-	SKH59	-	

General Technical Inform - Allgemeine Technische Info

D

Technical Info
Technische Info

ISO	Country and Standard · Standardbezeichnung nach Länder						Main application Hauptanwendung
	China	USA	Germany	Japan	Daido Steel Co., Ltd (Japan)	Russia	
	GB	AISI/SAE	DIN	JIS	DAIDO	GOST	
P	Plastic die steel · Gesenkstahl						
	-	P20 mod.		-	PX5N		For mass production of large mirror dies. Automobile tail light, front fender of car, video camera, household electrical appliances etc Große hochglänzende Präzisionsgesenke für die Serienproduktion. Automobilteile, Videokameras, elektr. Haushaltsgeräte ect.
	-	-		-	NAK55		High precision mirror die. Video camera, music disc, Cosmetic Containers, transparent covers, transparent films etc Hochglänzende Präzisionsgesenke für Videokameras, Musik CDs, Kosmetik Behälter, Transparente Abdeckungen.
	-	-		-	NAK80		High precision mirror die. Video camera, music disc, Cosmetic Containers, transparent covers, transparent films etc Hochglänzende Präzisionsgesenke für Videokameras, Musik CDs, Kosmetik Behälter, Transparente Abdeckungen und Beläge.
	3Cr13	420 mod.		SUS420J2 mod.	S-STAR		For ultra-mirror corrosion resistant precise dies. Accessories of camera, CD, lens, watch case. Für ultra-fein spiegelnde korrosionsbeständige Gesenke für Zubehör von Kameras. CD, Linsen, Armbanduhren.
	Cold-working die steel · Kaltarbeitsstahl						
	-	02	-	SKS93	YK30		Stamping die, gauge calipers, paper cutter, auxiliary tools Für Gesenkstempel, Meßkaliber, Papierschneidmesser, Werkzeuge
	9CrWMn	01 mod.	-	SKS3 mod.	GOA		Blanking die, gauge calipers, drawing die, taps, Perforated punch. Für Schnittmatrizen, Meßkaliber, Gewindebohrer, Perforationswerkzeuge, Kaltziehsteine
	Cr12MoV	D2	X165CrMoV12	SKD11	DC11		Blanking die, cold forming die, cold drawing die, forming roller, punch Für Schnittmatrizen, Kaltformpressgesenke, Kaltziehsteine, Formwalzen.
	-	D2 mod.	-	SKD11 mod.	DC53		Blanking die, cold forming die, cold drawing die, forming roll, punch Für Schnittmatrizen, Kaltformpressgesenke, Kaltziehsteine, Formwalzen.
Hot-working die steel · Warmarbeitsstahl							
4Cr5MoSiV1	H13	X40CrMoV51	SKD61	DHA1		Aluminum-compression die, connecting parts of compression die, hot stamping die, hot extrusion die, thermal shear cutting blade Aluminium Druckgesenke, Verbindungsstücke für Druckgesenke, Heißpressgesenke, Heiß-Extruder-Gesenke, warmfeste Schnittmesser ect.	
-	-	-	-	DH21		Long life Aluminum compression die Alu-Druckgesenke für lange Lebensdauer	
-	-	-	-	DH31-S		Compression die, Druckgesenke	
-	-	-	-	DH2F		Compression die, plastic die Druckgesenke, Plastik-Gesenke	

General Technical Inform ▪ Allgemeine Technische Info

D

Technical Info
Technische Info

ISO	Country and Standard · Standardbezeichnung nach Länder											
	China	USA	Germany		Great Britain		Sweden	France	Italy	Spain	Japan	Russia
	GB	AISI/ SAE	W.-nr	DIN	BS	EN	SS	AFNOR	UNI	UNE	JIS	GOST
M	Stainless steel · Rostfreier Stahl											
	0Cr13; 1Cr12	403	1.4000	X6Cr13	403S17	-	2301	Z6C13	X6Cr13	F.3110	SUS403	08Ch13
	-	-	1.4001	X7Cr14	-	-	-	-	-	F.8401	-	-
	1Cr13	410	1.4006	X10Cr13	410S21	56A	2302	Z10C14	X12Cr13	F.3401	SUS410	12Ch13
	1Cr17	430	1.4016	X6Cr17	430S15	60	220	Z8C17	X8Cr17	F.3113	SUS430	12Ch17
	2Cr13	410	1.4021	X20Cr13	S62	56B; 56C	-	Z20C13	X20C13	F.3401	SUS410	20Ch13
	-	-	1.4027	G-X20Cr14	420C29	56B	-	Z20C13M	-	-	SCS2	20Ch13L
	4Cr13	-	1.4034	X46Cr13	420S45	56D	2304	Z40CM Z38C13M	X40Cr14	F.3405	SUS420J2	40Ch13
	1Cr17Ni2	431	1.4057	X20CrNi172	431S29	57	2321	Z15CNi6.02	X16CrNi16	F.3427	SUS431	20Ch17N2
	Y1Cr17	430F	1.4104	X12CrMoS17	-	-	2383	Z10CF17	X10CrS17	F.3117	SUS430F	-
	1Cr17Mo	434	1.4113	X6CrMo171	434S17	-	2325	Z8CD17.01	X8CrMo17	-	SUS434	-
	-	-	1.4313	X5CrNi134	425C11	-	-	Z4CND13.4M	-	-	SCS5	-
	-	-	1.4408	G-X6CrNiMo1810	316C16	-	-	-	-	F.8414	SCS14	07Ch18N10G2S2M2L
	4Cr9Si2	HW3	1.4718	X45CrSi93	401S45	52	-	Z45CS9	X45CrSi8	F.322	SUH1	40Ch9S2
	0Cr13Al	405	1.4724	X10CrAl13	403S17	-	-	Z10C13	X10CrAl12	F.311	SUS405	10Ch13SJ
	Cr17	430	1.4742	X10CrAl18	430S15	60	-	Z10CAS18	X8Cr17	F.3113	SUS430	15Ch18SJ
	8Cr20Si2Ni	HNV6	1.4757	X80CrNiSi20	443S65	59	-	Z80CSN20.02	X80CrSiNi20	F.320V	SUH4	-
	2Cr25N	446	1.4762	X10CrAl24	-	-	2322	Z10CAS24	X16Cr26	-	SUH446	-
	Austenitic stainless steel · Austenitischer Rostfreier Stahl											
	0Cr18Ni9	304	1.4301	X5CrNi1810	304S15	58E	2332	Z6CN18.09	X5CrNi1810	F.3551; F.3541; F.3504	SUS304	08Ch18N10
	1Cr18Ni9MoZr	303	1.4305	X10CrNiS189	303S21	58M	2346	Z10CNF18.09	X10CrNiS18.09	F.3508	SUS303	-
	0Cr19Ni10	304L	1.4306	X2CrNi1911	304S12	-	2352	Z2CN18.10	X2CrNi18.11	F.3503	SCS19	03Ch18N11
	-	-	1.4308	G-X6CrNi189	304C15	-	-	Z6CN18.10M	-	-	SCS13	07Ch18N9L
	Cr17Ni7	301	1.4310	X12CrNi177	-	-	2331	Z12CN17.07	X12CrNi1707	F.3517	SUS301	-
	-	304LN	1.4311	X2CrNiN1810	304S62	-	2371	Z2CN18.10	-	-	SUS304LN	-
	0Cr19Ni9	304	1.4350	X5CrNi189	304S31	58E	-	Z6CN18.09	X5CrNi1810	-	SUS304	-
	0Cr17Ni11Mo2	316	1.4401	X5CrNiMo1712	316S16	Z6CND17.11	2347	1.4401	X5CrNiMo1712	F.3543	SUS316	-
	00Cr17Ni13Mo2	316LN	1.4429	X2CrNiMo17133	-	-	2375	Z2CND17.13	-	-	SUS316LN	-
	0Cr27Ni12Mo3	316L	1.4435	X2CrNiMo18143	316S12	-	2353	Z2CDN17.13	X2CrNiMo1713	-	SCS16,	03Ch17N14M2
	00Cr19Ni13Mo3	317L	1.4438	X2CrNiMo17133	317S12	-	2367	Z2CND19.15	X2CrNiMo18.16	-	SUS317L	-
-	329L	1.4460	X8CrNiMo275	-	-	2324	-	-	-	SUS329L; SCH11; SCS11	-	
1Cr18Ni9Ti	321	1.4541	X6CrNiTi1810	2337	321S12	58B	Z6CNT18.10	X6CrNiTi1811	F.3553	SUS321	12Ch18N10T	
1Cr18Ni11Nb	347	1.4550	X6CrNiNb1810	347S17	58F	2338	Z6CNnb18.1	X6CrNiTi1811	F.3552	SUS347	08Ch18N12B	
1Cr18Ni12Mo2Ti	316Ti	1.4571	X6CrNiMoTi17122	320S17	58J	2350	Z6NDT17.12	X6CrNiMoTi17	F.3535	-	10Ch17N13M2T	

General Technical Inform - Allgemeine Technische Info

D

Technical Info
Technische Info

ISO	Country and Standard · Standardbezeichnung nach Länder												
	China	USA	Germany		Great Britain		Sweden	France	Italy	Spain	Japan	Russia	
	GB	AISI/SAE	W.-nr	DIN	BS	EN	SS	AFNOR	UNI	UNE	JIS	GOST	
M	Austenitic stainless steel · Austenitischer Rostfreier Stahl												
	-	-	1.4581	G-X5CrNiMoNb1810	318C7	-	-	-	Z4CNDNb1812M	XG8CrNiMo18	-	SCS22	-
	Cr17Ni12Mo3Nb	318	1.4583	X10CrNiMoNb1812	-	-	-	-	Z6CNDNb1713B	X6CrNiMoTiNb17	-	-	-
	1Cr23Ni13	309	1.4828	X15CrNiSi2012	309S24	-	-	-	Z15CNS20.1	-	-	SUH309	20Ch20N14S2
	0Cr25Ni20	310S	1.4845	X12CrNi2521	310S24	-	2361	-	Z12CN2520	X6CrNi2520	F.331	SUH310	20Ch23N18
	Cr15Ni36W3Ti	330	1.4864	X12NiCrSi3616	-	-	-	-	Z12CNS35.1	-	-	SUH330	-
	-	-	1.4865	G-X40NiCrSi3818	330C11	-	-	-	-	XG50NiCr3919	-	SCH15	-
	5Cr2Mn9Ni4N	EV8	1.4871	X53CrMnNiN219	349S54; 321S12	-	58B	-	Z52CMN21.0	X53CrMnNiN219	-	SUH35	55Ch20G9AN4
1Cr18Ni9Ti	321	1.4878	X12CrNiTi189	321S320	58C	-	-	Z6CNT18.12	X6CrNiTi1811	F.3523	SU321	09Ch18N10T	

ISO	Country and Standard · Standardbezeichnung nach Länder									
	China	USA	Germany	Great Britain	Sweden	France	Italy	Spain	Japan	Russia
K	Nodular cast iron · GGG									
	QT400-18	60-40-18	GGG40	400/17	0717-02	FGS370-17	GS370-17	FGE38-17	FCD400	VC 42-12
	QT450-10	65-45-12	--	420/12	--	FGS400-12	GS400-12	FGE42-12	FCD450	-
	QT500-7	70-50-05	GGG50	500/7	0727-02	FGS500-7	GS500-7	FGE50-7	FCD500	VC 50-2
	QT600-3	80-60-03	GGG60	600/7	0732-03	FGS600-2	GS600-2	FGE60-2	FCD600	VC 60-2
	QT700-2	100-70-03	GGG70	700/2	0737-01	FGS700-2	GS700-2	FGE70-2	FCD700	VC 70-2
	QT800-2	120-90-02	GGG80	800/2	0864-03	FGS800-2	GS800-2	FGE80-2	FCD800	VC 80-2
	QT900-2	--	--	900/2	--	--	--	--	--	-
	Grey cast iron · Grauguss									
	--	NO.60	GG40	--	0140	FGL400	--	--	--	Sc 40
	HT350	NO.50	GG35	350	0135	FGL350	G35	FG35	FC350	Sc 35
	HT300	NO.45	GG30	300	0130	FGL300	G30	FG30	FC300	Sc 30
	HT250	NO.35	GG25	250	0125	FGL250	G25	FG25	FC250	Sc 25
	HT200	NO.30	GG20	200	0120	FGL200	G20	FG20	FC200	Sc 20
	HT150	NO.20	GG15	150	0115	FGL150	G15	FG15	FC150	Sc 15
HT100	--	--	100	0110	--	G10	--	FC100	-	

ISO	Country and Standard · Standardbezeichnung nach Länder											
	China	USA	Germany		Great Britain		Sweden	France	Italy	Spain	Japan	Russia
	GB	AISI/SAE	W.-nr	DIN	BS	EN	SS	AFNOR	UNI	UNE	JIS	GOST
H	Hardened materials · Gehärtete Werkstoffe											
	-	440A	1.4108	X100CrMo03	-	-	2258 08	-	-	-	C4BS	-
	-	610	1.4111	X100CrMoV15	-	-	2534 05	-	-	-	AC4A	-
-	0-2	-	X65CrMo14	-	-	2541 06	-	-	-	AC4A	-	

General Technical Inform ▪ Allgemeine Technische Info

D

Technical Info
Technische Info

ISO	Country and Standard · Standardbezeichnung nach Länder												
	China	USA	Germany		Great Britain		Sweden	France	Italy	Spain	Japan		Russia
	GB	AISI/SAE	W.-nr	DIN	BS	EN	SS	AFNOR	UNI	UNE	JIS		GOST
N	Aluminium-based alloys · Aluminium Legierungen												
	-	SC64D	3.2373	G-AISI9MGWA			4251	A-S7G			C4BS	-	
	-	DG-AISI12		G-ALMG5	LM5		4252	A-SU12			AC4A		
	-	356.1			LM25		4244				A5052		
	-	A413.0		GD-AISI12			4247				A6061		
	-	A380.1		GD-AISI8Cu3	LM24		4250				A7075		
	-	A413.1		G-AISI12(Cu)	LM20		4260				ADC12		
	-	A413.2		G-AISI12	LM6		4261						
-	A360.2		G-AISI10Mg(Cu)	LM9		4253							

ISO	Country and Standard · Standardbezeichnung nach Länder												
	China	USA	Germany		Great Britain		Sweden	France	Italy	Spain	Japan		Russia
	GB	AISI/SAE	W.-nr	DIN	BS	EN	SS	AFNOR	UNI	UNE	JIS		GOST
S	Nickel based alloys · Nickel Legierungen												
	-	5391	LW2 4670	S-NiCr13A16MoNb	mar-46	-	-	NC12AD	-	-			
	-	AMS 5397	LW2 4674	NiCo15Cr10MoAlTi	-	-	-	-	-	-			
	-	5660	LW2.4662	NiFe35Cr14MoTi	-	-	-	ZSNCDT42	-	-			
	-	5383	LW2.4668	NiCr19Fe19NbMo	HR8	-	-	NC19eNB	-	-			
	-	-	2.4631	NiCr20TiAk	Hr401.601	-	-	NC20TA	-	-		-	
	-	AMS 5399	2.4973	NiCr19Co11MoTi	-	-	-	NC19KDT	-	-		-	
	-	AMS 5544	LW2.4668	NiCr19Fe19NbMo	-	-	-	NC20K14	-	-			
	-	5390A	2.4603	-	-	-	-	NC22FeD	-	-		-	
	-	5666	2.4856	NiCr22Mo9Nb	-	-	-	NC22FeDNB	-	-		-	
	-	-	2.4630	NiCr20Ti	HR5.2034	-	-	NC20T	-	-		-	
	-	4676	2.4375	NiCu30AL3Ti	3072-76	-	-	-	-	-		-	
	Cobalt based alloys · Kobalt Legierungen												
	-	5537C AMS		CoCr20W15Ni	-	-	-	KC20WN	-	-			
	-	5772	LW2.4964	CoCr20W14Ni				KC22WN					
	Titanium alloys · Titanium Legierungen												
	-	UNS R54520	3.7115.1	TiAl5Sn2.5	TA14/17	-	-	T-A5E	-	-			
	-							UNS R56400					
	-	-	3.7165.1	TiAl6V4	TA10-13/ TA28		-	UNS R56401	T-A6V	-	-		
	-			TiAl5V5Mo5Cr3									
	-	-	3.7185	TiAl4Mo4Sn4Si0.5	-	-	-	-	-	-			

Fitting dimension tolerance · Passtoleranzen

Basic dimensions (mm)		Standard tolerance class of holes · Standard-Toleranzklassen																	
		IT1	IT2	IT3	IT4	IT5	IT6	IT7	IT8	IT9	IT10	IT11	IT12	IT13	IT14	IT15	IT16	IT17	IT18
>	≤	µm											mm						
---	3	0.8	1.2	2	3	4	6	10	14	25	40	60	0.1	0.14	0.25	0.4	0.6	1	1.4
3	6	1	1.5	2.5	4	5	8	12	18	30	48	75	0.12	0.18	0.3	0.48	0.75	1.2	1.8
6	10	1	1.5	2.5	4	6	9	15	22	36	58	90	0.15	0.22	0.36	0.58	0.9	1.5	2.2
10	18	1.2	2	3	5	8	11	18	27	43	70	110	0.18	0.27	0.43	0.7	1.1	1.8	2.7
18	30	1.5	2.5	4	6	9	13	21	33	52	84	130	0.21	0.33	0.52	0.84	1.3	2.1	3.3
30	50	1.5	2.5	4	7	11	16	25	39	62	100	160	0.25	0.39	0.62	1	1.6	2.5	3.9
50	80	2	3	5	8	13	19	30	46	74	120	190	0.3	0.46	0.74	1.2	1.9	3	4.6
80	120	2.5	4	6	10	15	22	35	54	87	140	220	0.35	0.54	0.87	1.4	2.2	3.5	5.4
120	180	3.5	5	8	12	18	25	40	63	100	160	250	0.4	0.63	1	1.6	2.5	4	6.3
180	250	4.5	7	10	14	20	29	46	72	115	185	290	0.46	0.72	1.15	1.85	2.9	4.6	7.2
250	315	6	8	12	16	23	32	52	81	130	210	320	0.52	0.81	1.3	2.1	3.2	5.2	8.1
315	400	7	9	13	18	25	36	57	89	140	230	360	0.57	0.89	1.4	2.3	3.6	5.7	8.9
400	500	8	10	15	20	27	40	63	97	155	250	400	0.63	0.97	1.55	2.5	4	6.3	9.7
500	630	9	11	16	22	32	44	70	110	175	280	440	0.7	1.1	1.75	2.8	4.4	7	11
630	800	10	13	18	25	36	50	80	125	200	320	500	0.8	1.25	2	3.2	5	8	12.5
800	1000	11	15	21	28	40	56	90	140	230	360	560	0.9	1.4	2.3	3.6	5.6	9	14
1000	1250	13	18	24	33	47	66	105	165	260	420	660	1.05	1.65	2.6	4.2	6.6	10.5	16.5
1250	1600	15	21	29	39	55	78	125	195	310	500	780	1.25	1.95	3.1	5	7.8	12.5	19.5
1600	2000	18	25	35	46	65	92	150	230	370	600	920	1.5	2.3	3.7	6	9.2	15	23
2000	2500	22	30	41	55	78	110	175	280	440	700	1100	1.75	2.8	4.4	7	11	17.5	28
2500	3150	26	36	50	68	96	135	210	330	540	860	1350	2.1	3.3	5.4	8.6	13.5	21	33

Note:

From IT1 to IT5, the standard tolerance with basic dimension more than 500 mm is as trial.
When the basic dimension 1 mm, the tolerances from IT4 to IT8 are invalid.

Bemerkung:

Für die Standardt Toleranzen IT1 bis IT5 bei Durchmesser über 500 mm ist eine Anpassung notwendig. Bei Basis abmessungen unter 1 mm ist das Toleranzfeld IT4 bis IT8 ungültig.

The shaft lower deviation(ei) and upper deviation (es) can be obtained by basic tolerance and standard tolerance (IT) of shaft.

Toleranz Einheitswelle: Die geringste Abweichung (ei) und die größte Abweichung (es) sind als Basis bzw. Standard-Toleranzen (IT) in der Tabelle angegeben.

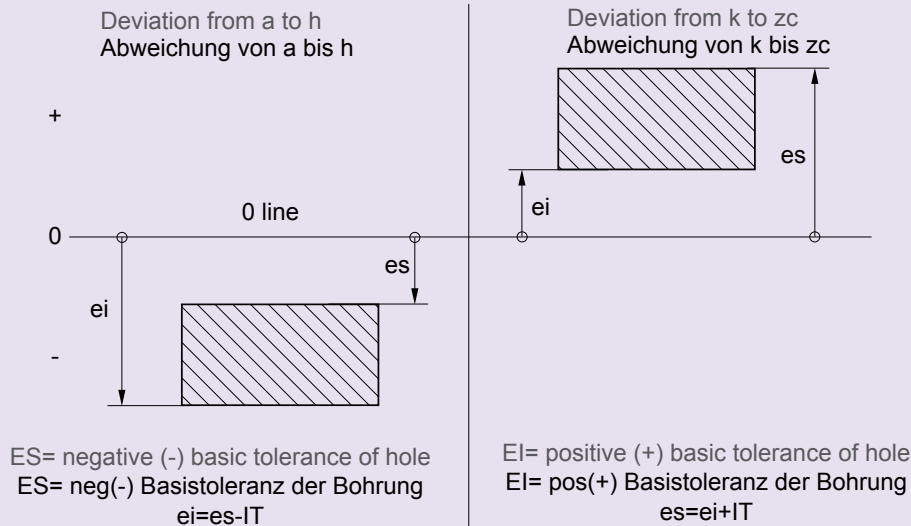

The hole lower deviation(EI) and upper deviation (ES) can be obtained by basic tolerance and standard tolerance (IT) of hole.

Toleranz Einheitsbohrung: Die geringste Abweichung (EI) und die größte Abweichung (ES) sind als Basis bzw. Standard-Toleranzen (IT)- Bohrung in der Tabelle angegeben.

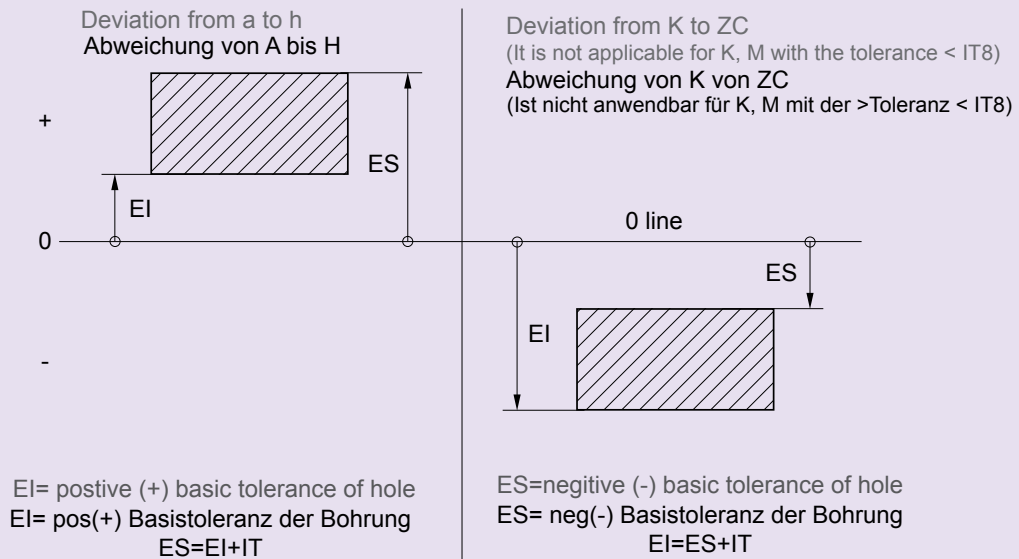

For example: for a hole with diameter 3 mm and tolerance H7, we can find that the lower deviation EI=0 in relation to H7 from the basic tolerance table, and the standard tolerance IT=10µm corresponding to H7, thus the upper deviation ES=EI+IT=10µm. Therefore the hole fitting

dimension is $\varnothing 3_0^{+0.01}$ mm.

Beispiel: Bei einem Durchmesser von 3mm und einer Toleranz H7 ist bei der Basis Toleranz H7 EI=0 bei der Standard-Toleranz H7 ist es IT=10µm. Die größte Abweichung ist demzufolge: ES=EI+IT=10µm.

Die Bohrungstoleranz ist bei einem $\varnothing 3_0^{+0.01}$ mm.

General Technical Inform - Allgemeine Technische Info

- Basic deviations value of shaft
- Basistoleranzwerte Einheitswelle

Diameter Durchmesser Ø (mm)		Basic deviation value · Basistoleranzwerte												
		Upper deviation es · Höchstabweichung												
		Standard tolerance class · Standard-Toleranzklasse												
>	≤	a	b	c	cd	d	e	ef	f	fg	g	h	js	
---	3	-270	-140	-60	-34	-20	-14	-10	-6	-4	-2	0	Die Formel für die Abweichung $\pm \frac{IT_n}{2}$, ITn ist der IT Wert entsprechend zu "n" zugeordnet.	
3	6	-270	-140	-70	-46	-30	-20	-14	-10	-6	-4	0		
6	10	-280	-150	-80	-56	-40	-25	-18	-13	-8	-5	0		
10	14	-290	-150	-95		-50	-32		-16		-6	0		
14	18													
18	24	-300	-160	-110		-65	-40		-20		-7	0		
24	30													
30	40	-310	-170	-120		-80	-50		-25		-9	0		
40	50	-320	-180	-130										
50	65	-340	-190	-140		-100	-60		-30		-10	0		
65	80	-360	-200	-150										
80	100	-380	-220	-170		-120	-72		-36		-12	0		
100	120	-410	-240	-180										
120	140	-460	-260	-200										
140	160	-520	-280	-210		-145	-85		-43		-14	0		
160	180	-580	-310	-230										
180	200	-660	-340	-240										
200	225	-740	-380	-260		-170	-100		-50		-15	0		
225	250	-820	-420	-280										
250	280	-920	-480	-300		-190	-110		-56		-17	0		
280	315	-1050	-540	-330										
315	355	-1200	-600	-360		-210	-125		-62		-18	0		
355	400	-1350	-680	-400										
400	450	-1500	-760	-440		-230	-135		-68		-20	0		
450	500	-1650	-840	-480										
500	560					-260	-145		-76		-22	0		
560	630													
630	710					-290	-160		-80		-24	0		
710	800													
800	900					-320	-170		-86		-26	0		
900	1000													
1000	1120					-350	-195		-98		-28	0		
1120	1250													
1250	1400					-390	-220		-110		-30	0		
1400	1600													
1600	1800					-430	-240		-120		-32	0		
1800	2000													
2000	2240					-480	-260		-130		-34	0		
2240	2500													
2500	2800					-520	-290		-145		-38	0		
2800	3150													

Note: 1. If basic dimension ≤ 1mm, the basic deviation a and b are not adopted.

Bemerkungen: 1. Bei Abmessungen ≤ 1mm, sind die Basisabweichungen a und b nicht berücksichtigt.

D

Technical Info
Technische Info

General Technical Inform ▪ Allgemeine Technische Info

µm

Basic deviation value · Basistoleranzwerte Einheitswelle																			
Lower deviation ei · geringste Abweichung																			
IT5 IT6	IT7	IT8	IT4 IT7	≤IT3 >IT7	Standard tolerance class · Standard-Toleranzklasse														
j			k		m	n	p	r	s	t	u	v	x	y	z	zn	zb	zc	
-2	-4	-6	0	0	+2	+4	+6	+10	+14		+18		+20		+26	+32	+40	+60	
-2	-4		+1	0	+4	+8	+12	+15	+19		+23		+28		+35	+42	+50	+80	
-2	-5		+1	0	+6	+10	+15	+19	+23		+28		+34		+42	+52	+67	+97	
-3	-6		+1	0	+7	+12	+18	+23	+28		+33		+40		+50	+64	+90	+130	
												+39	+45		+60	+77	+108	+150	
-4	-8		+2	0	+8	+15	+22	+28	+35		+41	+47	+54	+63	+73	+98	+136	+188	
											+41	+48	+55	+64	+75	+88	+118	+160	+218
-5	-10		+2	0	+9	+17	+26	+34	+43		+48	+60	+68	+80	+94	+112	+148	+200	+274
											+54	+70	+81	+97	+114	+136	+180	+242	+325
-7	-12		+2	0	+11	+20	+32	+41	+53	+66	+87	+102	+122	+144	+172	+226	+300	+405	
								+43	+59	+75	+102	+120	+146	+174	+210	+274	+360	+480	
-9	-15		+3	0	+13	+23	+37	+51	+71	+91	+124	+146	+178	+214	+258	+335	+445	+585	
								+54	+79	+104	+144	+172	+210	+254	+310	+400	+525	+690	
-11	-18		+3	0	+15	+27	+43	+63	+92	+122	+170	+202	+248	+300	+365	+470	+620	+800	
								+65	+100	+134	+190	+228	+280	+340	+415	+535	+700	+900	
								+68	+108	+146	+210	+252	+310	+380	+465	+600	+780	+1000	
-13	-21		+4	0	+17	+31	+50	+77	+122	+166	+236	+284	+350	+425	+520	+670	+880	+1150	
								+80	+130	+180	+258	+310	+385	+470	+575	+740	+960	+1250	
								+84	+140	+196	+284	+340	+425	+520	+640	+820	+1050	+1350	
-16	-26		+4	0	+20	+34	+56	+94	+158	+218	+315	+385	+475	+580	+710	+920	+1200	+1550	
								+98	+170	+240	+350	+425	+525	+650	+790	+1000	+1300	+1700	
-18	-28		+4	0	+21	+37	+62	+108	+190	+268	+390	+475	+590	+730	+900	+1150	+1500	+1900	
								+114	+208	+294	+435	+530	+660	+820	+1000	+1300	+1650	+2100	
-20	-32		+5	0	+23	+40	+68	+126	+232	+330	+490	+595	+740	+920	+1100	+1450	+1850	+2400	
								+132	+252	+360	+540	+660	+820	+1000	+1250	+1600	+2100	+2600	
			0	0	+26	+44	+78	+150	+280	+400	+600								
								+155	+310	+450	+660								
			0	0	+30	+50	+88	+175	+340	+500	+740								
								+185	+380	+560	+840								
			0	0	+34	+56	+100	+210	+430	+620	+940								
								+220	+470	+680	+1050								
			0	0	+40	+66	+120	+250	+520	+780	+1150								
								+260	+580	+840	+1300								
			0	0	+48	+78	+140	+300	+640	+960	+1450								
								+330	+720	+1050	+1600								
			0	0	+58	+92	+170	+370	+820	+1200	+1850								
								+400	+920	+1350	+2000								
			0	0	+68	+110	+195	+440	+1000	+1500	+2300								
								+460	+1100	+1650	+2500								
			0	0	+76	+135	+240	+550	+1250	+1900	+2900								
								+580	+1400	+2100	+3200								



Technical Info
Technische Info

General Technical Inform - Allgemeine Technische Info

- Basic deviations value of hole
- Basistoleranzwerte Einheitsbohrung

Diameter Durchmesser Ø (mm)		Basic deviation value · Basis-Toleranzwerte Einheitswelle																						
		Lower deviation EI · geringste Abweichung EI											Upper deviation ES · Höchstabweichung ES											
		Standard tolerance class · Standard-Toleranzklasse											IT6	IT7	IT8	≤IT8	>IT8	≤IT8	>IT8	≤IT8	>IT8	≤IT7		
>	≤	A	B	C	CD	D	E	EF	F	FG	G	H	JS	J		K		M		N		P to ZC		
---	3	+270	+140	+60	+34	+20	+14	+10	+6	+4	+2	0	In the formula Deviation = ± $\frac{IT_n}{2}$, ITn is the IT value corresponding to 'n'. Die Formel für die Abweichung = ± $\frac{IT_n}{2}$, ITn ist der IT Wert entsprechend zu 'n' zugeordnet.	+2	+4	+6	0	0	-2	-2	-4	-4	Wenn IT ≥ IT7, wird der Δ wert zuaddiert. If IT ≥ IT7, add a Δ value to the relevant value	
3	6	+270	+140	+70	+46	+30	+20	+14	+10	+6	+4	0		+5	+6	+10	-1+Δ		-4+Δ	-4	-8+Δ	0		
6	10	+280	+150	+80	+56	+40	+25	+18	+13	+8	+5	0		+5	+8	+12	-1+Δ		-6+Δ	-6	-10+Δ	0		
10	14	+290	+150	+95		+50	+32		+16		+6	0			+6	+10	+15	-1+Δ		-7+Δ	-7	-12+Δ		0
14	18																							
18	24	+300	+160	+110		+65	+40		+20		+7	0			+8	+12	+20	-2+Δ		-8+Δ	-8	-15+Δ		0
24	30																							
30	40	+310	+170	+120		+80	+50		+25		+9	0			+10	+14	+24	-2+Δ		-9+Δ	-9	-17+Δ		0
40	50	+320	+180	+130																				
50	65	+340	+190	+140		+100	+60		+30		+10	0			+13	+18	+28	-2+Δ		-11+Δ	-11	-20+Δ		0
65	80	+360	+200	+150																				
80	100	+380	+220	+170		+120	+72		+36		+12	0			+16	+22	+34	-3+Δ		-13+Δ	-13	-23+Δ		0
100	120	+410	+240	+180																				
120	140	+460	+260	+200		+145	+85		+43		+14	0			+18	+26	+41	-3+Δ		-15+Δ	-15	-27+Δ		0
140	160	+520	+280	+210																				
160	180	+580	+310	+230		+170	+100		+50		+15	0			+22	+30	+47	-4+Δ		-17+Δ	-17	-31+Δ		0
180	200	+660	+340	+240																				
200	225	+740	+380	+260		+190	+110		+56		+17	0			+25	+36	+55	-4+Δ		-20+Δ	-20	-34+Δ		0
225	260	+820	+420	+280																				
260	280	+920	+480	+300		+210	+125		+62		+18	0			+29	+39	+60	-4+Δ		-21+Δ	-21	-37+Δ		0
315	355	+1200	+600	+360																				
355	400	+1350	+680	+400		+230	+135		+68		+20	0			+33	+43	+66	-5+Δ		-23+Δ	-23	-40+Δ		0
400	450	+1500	+760	+440																				
450	500	+1650	+840	+480		+260	+145		+76		+22	0								0		-26		-44
500	560																							
560	630					+290	+160		+80		+24	0								0		-30		-50
630	710																							
710	800					+320	+170		+86		+26	0								0		-34		-56
800	900																							
900	1000					+350	+195		+98		+28	0								0		-40		-66
1000	1120																							
1120	1250					+390	+220		+110		+30	0								0		-48		-78
1250	1400																							
1400	1600					+430	+240		+120		+32	0							0		-58	-92		
1600	1800																							
1800	2000					+480	+260		+130		+34	0							0		-68	-110		
2000	2240																							
2240	2500					+520	+290		+145		+38	0							0		-76	-135		
2500	2800																							
2800	3150																							

D

Technical Info
Technische Info

General Technical Inform ▪ Allgemeine Technische Info

µm

Basic deviation value · Basis-Toleranzwerte Einheitswelle												Δ					
Upper deviation ES · Höchstabweichung ES																	
Standard tolerance class >IT7 · Standard-Toleranzklasse > IT7												Standard tolerance class Standard-Toleranzklasse					
P	R	S	T	U	V	X	Y	Z	ZA	ZB	ZC	IT3	IT4	IT5	IT6	IT7	IT8
-6	-10	-14		-18		-20		-26	-32	-40	-60	0	0	0	0	0	0
-12	-15	-19		-23		-28		-35	-42	-50	-80	1	1.5	1	3	4	6
-15	-19	-23		-28		-34		-42	-52	-67	-97	1	1.5	2	3	6	7
-18	-23	-28		-33		-40		-50	-64	-90	-130	1	2	3	3	7	9
					-39	-45		-60	-77	-108	-150						
-22	-28	-35		-41	-47	-54	-63	-73	-98	-136	-188	1.5	2	3	4	8	12
			-41	-48	-55	-64	-75	-88	-118	-160	-218						
-26	-34	-43	-48	-60	-68	-80	-94	-112	-148	-200	-274	1.5	3	4	5	9	14
			-54	-70	-81	-97	-114	-136	-180	-242	-325						
-32	-41	-53	-66	-87	-102	-122	-144	-172	-226	-300	-405	2	3	5	6	11	16
	-43	-59	-75	-102	-120	-146	-174	-210	-274	-360	-480						
-37	-51	-71	-91	-124	-146	-178	-214	-258	-335	-445	-585	2	4	5	7	13	19
	-54	-79	-104	-144	-172	-210	-254	-310	-400	-525	-690						
-43	-63	-92	-122	-170	-202	-248	-300	-365	-470	-620	-800	3	4	6	7	15	23
	-65	-100	-134	-190	-228	-280	-340	-415	-535	-700	-900						
	-68	-108	-146	-210	-252	-310	-380	-465	-600	-780	-1000						
-50	-77	-122	-166	-236	-284	-350	-425	-520	-670	-880	-1150	3	4	6	9	17	26
	-80	-130	-180	-258	-310	-385	-470	-575	-740	-960	-1250						
	-84	-140	-196	-284	-340	-425	-520	-640	-820	-1050	-1350						
-56	-94	-158	-218	-315	-385	-475	-580	-710	-920	-1200	-1550	4	4	7	9	20	29
	-98	-170	-240	-350	-425	-525	-650	-790	-1000	-1300	-1700						
-62	-108	-190	-268	-390	-475	-590	-730	-900	-1150	-1500	-1900	4	5	7	11	21	32
	-114	-208	-294	-435	-530	-660	-820	-1000	-1300	-1650	-2100						
-68	-126	-232	-330	-490	-595	-740	-920	-1100	-1450	-1850	-2400	5	5	7	13	23	34
	-132	-252	-360	-540	-660	-820	-1000	-1250	-1600	-2100	-2600						
-78	-150	-280	-400	-600													
	-155	-310	-450	-660													
-88	-175	-340	-500	-740													
	-185	-380	-560	-840													
100	-210 -220	-430 -470	-620 -680	-940 -1050													
-120	-250 -260	-520 -580	-780 -840	-1150 -1300													
-140	-300 -330	-640 -720	-960 -1050	-1450 -1600													
-170	-370	-820	-1200	-1850													
	-400	-920	-1350	-2000													
-195	-440 -460	-1000 -1100	-1500 -1650	-2300 -2500													
-240	-550 -580	-1250 -1400	-1900 -2100	-2900 -3200													

D

Technical Info
Technische Info

Hardness reference table (conversion of hardness and strength for ferrous metal) Härte Vergleichstabelle (Konversationstabelle von Härte und Zugfestigkeit für Stahl)

Hardness · Härte				Tensile strength Zugfestigkeit N/mm ²	Hardness · Härte				Tensile strength Zugfestigkeit N/mm ²
Rockwell hardness · Härte		Vickers hardn. · Härte	Brinell hardn. · Härte		Rockwell hardness · Härte		Vickers hardn. · Härte	Brinell hardn. · Härte	
HRC	HRA	HV	HB		HRC	HRA	HV	HB	
70.0	86.6	1037	—	—	51.0	76.3	525	501	1780
69.5	86.3	1017	—	—	50.5	76.1	517	494	1750
69.0	86.1	997	—	—	50.0	75.8	509	488	1720
68.5	85.8	978	—	—	49.5	75.5	501	481	1690
68.0	85.5	959	—	—	49.0	75.3	493	474	1660
67.5	85.2	941	—	—	48.5	75.0	485	468	1630
67.0	85.0	923	—	—	48.0	74.7	478	461	1605
66.5	84.7	906	—	—	47.5	74.5	470	455	1575
66.0	84.4	889	—	—	47.0	74.2	463	449	1550
65.5	84.1	872	—	—	46.5	73.9	456	442	1525
65.0	83.9	856	—	—	46.0	73.7	449	436	1500
64.5	83.6	840	—	—	45.5	73.4	443	430	1475
64.0	83.3	825	—	—	45.0	73.2	436	424	1450
63.5	83.1	810	—	—	44.5	72.9	429	418	1430
63.0	82.8	795	—	—	44.0	72.6	423	413	1405
62.5	82.5	780	—	—	43.5	72.4	417	407	1385
62.0	82.2	766	—	—	43.0	72.1	411	401	1360
61.5	82.0	752	—	—	42.5	71.8	405	396	1340
61.0	81.7	739	—	—	42.0	71.6	399	391	1320
60.5	81.4	726	—	—	41.5	71.3	393	385	1300
60.0	81.2	713	—	2555	41.0	71.1	388	380	1280
59.5	80.9	700	—	2500	40.0	70.8	382	375	1260
59.0	80.6	688	—	2450	40.0	70.5	377	370	1245
58.5	80.3	676	—	2395	39.5	70.3	372	365	1225
58.0	80.1	664	—	2345	39.0	70.0	367	360	1210
57.5	79.8	653	—	2295	38.5	—	362	355	1190
57.0	79.5	642	—	2250	38.0	—	357	350	1175
56.5	79.3	631	—	2205	37.5	—	352	345	1160
56.0	79.0	620	—	2160	37.0	—	347	341	1140
55.5	78.7	609	—	2115	36.5	—	342	336	1125
55.0	78.5	599	—	2075	36.0	—	338	332	1110
54.5	78.2	589	—	2035	35.5	—	333	327	1095
54.0	77.9	579	—	1995	35.0	—	329	323	1080
53.5	77.7	570	—	1955	34.5	—	324	318	1065
53.0	77.4	561	—	1920	34.0	—	320	314	1050
52.5	77.1	551	—	1885	33.5	—	316	310	1035
52.0	76.9	543	—	1850	33.0	—	312	306	1020
51.5	76.6	534	—	1815	32.5	—	308	302	1010

D

Technical Info
Technische Info

Hardness reference table (conversion of hardness and strength for ferrous metal) Härte Vergleichstabelle (Konversationstabelle von Härte und Zugfestigkeit für Stahl)

Hardness · Härte				Tensile strength Zugfestigkeit N/mm ²	Hardness · Härte				Tensile strength Zugfestigkeit N/mm ²
Rockwell hardness · Härte		Vickers hardn. · Härte	Brinell hardn. · Härte		Rockwell hardness · Härte		Vickers hardn. · Härte	Brinell hardn. · Härte	
HRC	HRA	HV	HB		HRC	HRA	HV	HB	
32.0	—	304	298	995	24.0	—	249	245	820
31.5	—	300	294	980	23.5	—	246	242	810
31.0	—	296	291	970	23.0	—	243	240	800
30.5	—	292	287	960	22.5	—	240	237	790
30.0	—	289	283	950	22.0	—	237	234	785
29.5	—	285	280	935	21.5	—	234	232	775
29.0	—	281	276	920	21.0	—	231	229	765
28.5	—	278	273	910	20.5	—	229	227	760
28.0	—	274	269	900	20.0	—	226	225	750
27.5	—	271	266	890	19.5	—	223	222	745
27.0	—	268	263	880	19.0	—	221	220	735
26.5	—	264	260	870	18.5	—	218	218	730
26.0	—	261	257	860	18.0	—	216	216	725
25.5	—	258	254	850	17.5	—	214	214	715
25.0	—	255	251	835	17.0	—	211	211	710
24.5	—	252	248	830					

Note: The conversion values for steel in the table are commonly applicable for the steels with carbon from low to high.
Bemerkung: Die in der Tabelle aufgeführten Werte sind für Kohlenstoffstahl anwendbar.

General Technical Inform - Allgemeine Technische Info

Comparison table for turning inserts chip breaker - Übersichtstabelle der WSP-Spanbrecher

ISO		Comparison table for turning inserts chip breaker Übersichtstabelle der WSP-Spanbrecher																									
		Application Anwendung	ZCC-CT		Sandvik		Seco		Kennametal		ISCAR		Walter		Mitsubishi		Sumitomo		Tungaloy		Kyocera		Korloy		Ingersoll Tague Tec		
P	Steel · Stahl	Neg	Pos	Neg	Pos	Neg	Pos	Neg	Pos	Neg	Pos	Neg	Pos	Neg	Pos	Neg	Pos	Neg	Pos	Neg	Pos	Neg	Pos	Neg	Pos		
				WG		WF WL	WF WK	W-MF2	W-F1	FW-MW	FW-MW	WF	NF	PF	SW	FW	NLU-W	NLU-W	ASW	WP	VW LW				WS		
		DF EF	SF HF	PF UF	PF UF	FF1 MF1	FF1 F1	11 UF	11 UF	SF	NF3 NS6	PF4 PF5	FH FS	FJ FV	NSE NSU NLU NFA NFL	DP GP	PF 01	DP GP	VG VF	VL			FG FC	VF		FASA FG	
		DM EM	HM	PM QM	PM UM	MF2	F2	MF	MF	NF TF SM	NS6	PS5	SH SA	SW SV	NSU NSC NSK	TS TM	HQ CQ	CK DP	VQ VC	VB			WTML			WT	
		DM PM	HR	PM QM	PR UR	M3 MF3	F2	MN	MF	GN PP NR	NM4 NM6	PM5	MV MZ	MV MW	NGE NGU NUX	TM DM	GS CS	HQ XQ	VM				PC MC MT MG MF			PC MT PMR	
				WR WM	WM	W-M3 W-R4 W-R7	W-F2	MW	MW	WG	NM	PM	MW		NGU-W		WQ										
		DR		PR QR	31	M5 MR5 MR7		RP UN RN		TNM GN	NM9	GH MAT MT			NMU NMX	TH TR TU	PT GT HT	G St-form			HR		RT				
		HDR 31HPR DR LR		HR QR		R8 RR9 -56 -57 -UX		RH RM RP		NM	NR6 NR8	HA HZ HH HV HX			NMP NHG NHP NHU NHW		HX			GH VH VT			HT HD HY HZ RX RH			CMX	
		WG		WF WL	WF WK	W-MF2		FW MW	FW MW	WF		PF	SW	FW	NLU-W												
		EF DF	EF HF	MF UF	MF1	FF1 F2	F1	FF FP	11 UF	NF VL	NF4	PF4 PF5	FS	FJ FV	NSU NLU	SS	GU				VF		EASF			FG	
		EF EM	EF EM HF HM	MF MM	MF MM UM	MF3	F2	FP	MF	PP TF 14 16 17 19	NM4	SH MS	SW SV	NSU	SS SM	MS	CK DP	GP VF	XP		HMP						
		EM DM	EM HM	MM UM	MM UM	R6 56	F2	MP	HP	PP TF 19	NM4 NR4	MES MH	MV MW	NGU	SAS	MS	HQ XQ	GK G							MT PMR WT		
				WR WM	WM	W-M3		MW RW	MW	WG		PM	MW		NGU -W												
		ER DR	HR	MR QR	MR	R7 R8		MP-P		HTW NR	NR4	GH HZ		NMU NMX NHG						VM						CMX	
		ER DR HDR LR		HR QR		-56		RP		NM				NMP NHG NHP NHU NHW													

M Stainless Steel · Rostfreier Stahl

General Technical Inform - Allgemeine Technische Info

Comparison table for turning inserts chip breaker - Übersichtstabelle der WSP-Spanbrecher

Comparison table for turning inserts chip breaker · Übersichtstabelle der WSP-Spanbrecher																										
ISO	Application Anwendung	ZCC-CT		Sandvik		Seco		Kennametal		ISCAR		Walter		Mitsubishi		Sumitomo		Tungaloy		Kyocera		Korloy		Ingersoll Tague Tec		
		Neg	Pos	Neg	Pos	Neg	Pos	Neg	Pos	Neg	Pos	Neg	Pos	Neg	Pos	Neg	Pos	Neg	Pos	Neg	Pos	Neg	Pos	Neg	Pos	
K Cast IronGuss	Wiper-finishing Wiper-Schichten	WG		WF WM	WF	W-MF2	W-F1	FW MW	FW MW	WF							NLU-W	NLU-W								
	Finishing · Schichten	DF	HF	KF	KF	F1	F1	FF FN	11 UF LF	NF SM	14 19	PS5				NSU	NLU	C				VM				
	Semi-finishing Schichten-Mittlere Bearbeitung	PM	HM	KF KM	KF KM	M3	F2	FN	MF	GN	14 19	NM5	GH			NUX NGU	NSU	C Stand- form	CM			B25	HMP			
	Medium machining light roughing Mittlere Bearbeitung-leichte Schruppbearbeitung	DR	HM HR	KM QM	KM	M3	F2	UN	HP	GN NR		NM6	PM5			NUZ NGU NMU	NMU	GC ZS	CM			VK GR	C25	MT MG	MT PMR WT	
	Wiper medium					W-M3 W-R4 W-R7		MW	MW	WG		NM	PM			NGU-W										
	Roughing Schruppbearbeitung	DR *NMA	HR	KR QR	KR UR	M5					NR	NR6		GH		NMU		ZS				MA		RT	CMX	
	Finishing · Schichten		LC		AL				LF		NF		PM2													
	Semi-finishing Schichten-Mittlere Bearbeitung		LC		AL		AL	GP			NF PP	AS											HA	AK	FL SA	
	Medium machining-light roughing Mittlere Bearbeitung- leichtes Schruppbearbeitung		LH		AL		AL	GG-FS MS	HP		NMS													AR		
	S Heat resist. super alloys & Ti- alloys Warmt. Legl. & Ti-Legierung	Finishing · Schichten	NF EF	NF	NGP	MF	MF1		FS	GT-HP	SF PF	PF SM		PF4		NSU							VP1			
Semi-finishing Schichten-Mittlere Bearbeitung		NF NM EM	NF	23	MM	MF1 M1		FS MS	GT-MF	SF PF	PF SM		PF5		NEX NUP							VP2	AK			
Medium machining-light roughing Mittlere Bearbeitung- leichte Schruppen					MM UM	M1		MS	MT-LF	PP TF					NMU							VP3	HMP	SU		
Roughing Schruppbearbeitung		ER		SR		MR3 MR4		RP		TF HTW NR												VM				



General Technical Inform - Allgemeine Technische Info

Coated Cemeted Carbide CVD - beschichtetes Hartmetall CVD

ISO	ZCC-CT	Sandvik	Kennametal	Sumitomo	Mitsubishi	Toshiba Tungaloy	Kyocera	Walter	Iscar	SECO	Korloy	Ingersoll Tague Tec	Widia
P Steel · Stahl	P01-05	YBC052	GC4205 GC4305	KCP05 KC9105	AC805P	UE6005 UE6105	T9005 T9105	CA5505	WPP01 WPP05	IC8150 IC9150 IC428	TP0500 TP0501		
	P10-15	YB6315 YBC152 YBC252	GC4315 GC4215	KCP10 KC9110	AC810P AC700G	UC6110 MY5015	T9015 T9115	CA510 CA5515 CA510	WPP10 WPP10S	IC8150 IC8250 IC9150 IC9250 IC9015	TP1500 TP1501	NC3010	TT8115 TT8125 WP15CT
	P20-25	YBC252 YBC251	GC4325 GC4225 GC4025	KCP25 KC9125	AC820P AC8020P AC900G AC2000	UE6020 MC6025	T9025 T9125	CA5525 CA525 CR9025	WPP20 WPP20S	IC8150 IC8250 IC9250 IC9025	TP2501 TP2500 TP200	NC3220 NC3120	TT8125 TT3500 WP25CT
P30-35	YBC352 YBC351	GC4335 GC4235 GC4035	KCP30 KC8050	AC830P AC3000	UE6035 UE6400	T903 T9135	CA530 CA5535 CA535	WPP30 WPP30S	IC8250 IC8350 IC9350 IC9025	TP3500	NC3030 NC5330 NC500H	TT5100 TT8135 WP35CT	
M10	YBM151 YBM153	GC2015 GC1515	KCM15	AC610M	MC7015	T9115			IC8250 IC9250 IC6015			TT9215 WM15CT	
M20	YBM253 YBM251	GC2015 GC2025	KCM25 KC9225	AC610M AC630M	US7020 MC7015 MC7025	T6020 T6120 T9125	CA6515	WAM20	IC8250 IC9350 IC9025 IC6025	TM 2000 TP200 TP2500	NC9025	TT5100 TT9225 WM25CT	
M30	YBM351 YBM253	GC2025 GC2035	KCM25 KCM35 KC9225	AC630M AC6030M AC830P AC3000	US735 US7025	T6030 T6130	CA6525	WAM30	IC8350 IC9350 IC9025	TP3500 TM4000		TT5100 TT7100 TT9235 WM35CT	
M40	YBM351	GC2035	KCM35 KC9240 KC9245	AC630M AC6030M AC830P AC3000	US735	T6030 T6130	CA6525		IC6025 IC9350	TP40		TT5100 TT7100 TT9235	
K01-05	YBD052	GC3005 GC3205	KCK05	AC405K AC410K	UC5005 UC5105	T5105	CA4505		IC5005 IC9007		NC6205	TT1300 TT7005 WK05CT	
K10-15	YB7315 YBD102 YBD152 YBD152C	GC3215	KCK15 KC9315	AC410K AC415K AC420K AC700G	MC5015 UC5115 MY5015	T5105 T5115	CA4010 CA4515 CA4115	WAK10 WAK10S	IC9015 IC9007 IC8150 IC5010 IC428 IC4028 IC9150	TK1001 TK1000	NC6210	TT1300 TT7310 T7015	
K20-25	YB7315 YBD152 YBD152C	GC3225	KCK20 KC9320	AC420K AC900G	MC5015 UE6110 MY5015	T5125 T9125	CA4125	WAK20 WKK20S	IC5010 IC428 IC4028 C9150	TK2000 TK2001	NC5330	WK20CT	



General Technical Inform ▪ Allgemeine Technische Info

Coated Cemeted Carbide PVD ▪ beschichtetes Hartmetall PVD

ISO	ZCC-CT	Sandvik	Kennametal	Sumitomo	Mitsubishi	Toshiba Tungaloy	Kyocera	Walter	Iscar	SECO	Korloy	Ingersoll Tague Tec	Widia
P Steel · Stahl	P01-05	GC1105					PR1005						
	P10-15	GC1515 GC1115 GC1025	KC5010 KC5510 KC7215 KC7315	AC510U	VP10MF VP15TF	AH710	PR930 PR1005 PR930 PR115	WSM10 WXN10	IC520N IC507 IC570 IC807 IC907 IC908				
	P20-25	GC1515 GC1125 GC1025	KC5025 KC5525 KU25T	AC520U	VP20RT VP20MF	AH725 AH120	PR930 PR1025 PR1225	WSM20 WMP20S WSM21	IC228 IC250 IC308 IC328 IC350 IC354 IC507 IC807 IC808 IC907 IC908 IC928 IC1008 IC1028 IC3028	CP200 CP250 TP2000 TS2500		TT8020 TT9020	
M Stainless Steel Rostfreier Stahl	P30-35	GC1125 GC2035	KC7335	AC530U		SH730 J740 GH130 AH740	PR660	WSM30	IC228 IC250 IC328 IC330 IC354 IC528 IC1008 IC1028 IC3028	CP500	PC5300		
	M10	GC1105 GC1115 GC1025 GC1125 GC1515	KCU10 KC5010 KC5510 KC6005 KC6015	EH10Z AC510U AC530U	VP10MF	AH710	PR915 PR1005	WSM10	IC330 IC354 IC507 IC520 IC570 IC807 IC1028 IC3028	CP500 TS2000	PC8110	TT5080	WS10PT
	M20	GC1025 GC1125	KC501 KC25	AC520U AC530U	VP10RT VP15TF VP20RT VP20MF	AH120 AH725 SH730 AH710 AH630 GH330	PR1025 PR1125 PR1225	WSM10 WMP20S WSM20 WSM21	IC228 IC250 IC354 IC808 IC908 IC1008 IC1028 IC3028	TS2000 TS2500 CP200 CP250		TT8020 TT9020 TT9080	WS25PT
S Heat resist. super all. & Ti- alloys Warmt. Legl. & Ti- Legierung	M30	GC2035	KC5025 KC25		VP10RT VP15TF VP20RT VP20MF MP7035	AH12 AH725 SH730 AH710 AH630 GH330 J740	PR1025 PR1125	WSM20 WSM21 WSM30	IC228 IC250 IC328 IC330 IC1008 IC1028 IC3028	CP500 TS2500	PC5300 PC9030		
	S05	S05F		MP9005	MP9005	AH905			IC507 IC907				
	S10	GC1105 GC1115	KG5010 KCU10 KC5510 KCS10	AC510U EH510Z	MP9015 VP10RT	AH905 SH730 AH110 AH120		WSM10	IC507 IC807 IC808 IC806 IC907	CP200 CP250 TS2000 TS2500	PC8110	TT5080	WS10PT
N Nonferrite Mat. Ne-metalle	S20	GC1025 GC1125 GC1515	KC5010 KCU10 KC5025 KC25 KC5525	AC520U EH520Z	MP9015 MP19015 VP20RT	AH120 AH725	PR1125	WSM20 WSM21 WSM30	IC507 IC807 IC907	CP250 TS2500 CP500	PC5300	TT5080 TT8020 TT9080	WS25PT
	S30			AC520U	VP15TF	AH725	PR1125	WSM30	IC3028 IC808 IC830		PC5400	TT8020	
	N10	GC1515	KC5410					WXN10	IC520				



Cutting material comparison table-Turning - Schneidstoff Vergleichstabelle-Drehen

■ Cermet

ISO	ZCC-CT	Sandvik	Kennametal	Sumitomo	Mitsubishi	Toshiba Tunggaloy	Kyocera	Walter	Iscar	SECO	Korloy	Ingersoll Tague Tec	Widia	
P P01-05 Steel - Stahl		CT5005		T110A T1000A	AP25N VP25N	NS520 AT520 GT520 GT720	TN30 TN6010 PV30 PV7010		IC20N IC520N		CN1000 CC105	CT3000 PV3010		
		CT5015 CT530	KT315 KT125	T1200A T2000Z T1500A T1500Z	NX2525 AP25N VP25N	NS520 NS730 GT730 NS9530 GT9530	TN60 TN6010 PV60 PV6010		IC20N IC520N IC530N	CM TP1020 TP1030 CMP	CN1000 CT10 CN2000 CC115	CT3000 PV3010	TT115	
		GC1525	KT325 KT1120 KT5020	T1200A T2000Z T1500A T1500Z	NX2525 NX3035 AP25N VP25N MP3025	NS530 NS730 GT730 NS9530 GT9530	TN60 TN6020 PV60 PV7020 PV7025		IC20N IC30N IC75T IC520N IC530N	CM TP1020 TP1030 CMP	CN20 CN2000 CC115		TT115	
				T3000Z	MP3025 VP45N	PV7025 PV90		IC75T						
M M10 M20 M30 M40 Stainless Steel Rostfreier Stahl		GC1525	KT125	T110A T1000A T1500Z T2000Z	NX2525 AP25N VP25N	NS520 AT530 GT530 GT720	TN60 TN6020 PV60 PV7020			CM TP1020 TP1030 CMP		CT3000 PV3010	TT115	
		CT5015 CT530	HT2	T110A T1000A T1500Z T2000Z	NX2525 AP25N VP25N	NS530 GT730 NS730	TN90 TN6020 PV90 PV7020 PV7025					CT3000 PV3010	TT115	
				T3000Z										
K K01-05 K10-15 K20-25 Cast Iron Guss				T110A T1000A T2000Z T1500Z	NX2525 AP25N	NS520 GT730 NS730	TN30 TN6010 PV30 PV7005 PV7010					CT3000 PV3010		
		CT5015	KT325 KT125	T1200A T1500A T2000Z T1500Z	NX2525 AP25N	NS520 GT730 NS730	TN60 TN6020 PV60 PV7020 PV7025					CN1000	CT3000 PV3010	TT115
		CT5015		T3000Z	NX2525 AP25N									



Cutting material comparison table-Turning · Schneidstoff Vergleichstabelle-Drehen

■ Carbide uncoated · Hartmetall Unbeschichtet

ISO	ZCC-CT	Sandvik	Kennametal	Sumitomo	Mitsubishi	Toshiba Tungaloy	Kyocera	Walter	Iscar	SECO	Korloy	Ingersoll Tague Tec	Widia
N Nonferrierte Mat. Ne-metalle	N01	H10 H13A	KF1	H1		KS05F				883 890			
	N10	H10 H13A	K313 K68 KF1 THM-F	H1	HT10	KS15F	KW10	WK01 WK10	IC20	890 KX HX	H01	K10	THM
	N20	H10 H13A	K313 K68 KF1 THM-F			KS15F	KW15		IC20	KX HX			

CVD milling grades - CVD Fräsen Klasse

Material / Class	ZCC-CT	Sandvik	Kennametal	Sumitomo	Mitsubishi	Toshiba Tungaloy	Kyocera	Walter	Iscar	SECO	Korloy	Ingersoll Tague Tec
P Steel - Stahl	P05	K20W GC4220			F7010							
	P10	K20W GC3040 GC4220 GC4230		ACP100	F7010				IC4100 IC5100	MP1500	NC5330 NCM325	IN6505 IN6520
	P20	GC3040 GC4230		CS3000	FH7020	T3130		WKP25 WKP25S	IC4050 IC4100 IC5100 IC5400	MP1500 MP2500 MS2500 T25M	NC5330 NCM325	IN6505 IN6520 IN7035
	P30	GC2040 GC4240	KC930M KC935M	CS3000	F7030	T3130		WKP35 WKP35S WTP35	IC4050 IC5400	MK3000 T25M T350M	NCM325	IN7035 IN6530
P40	GC2040 GC4240								T350M			IN6530
M Stainless Steel Rostfreier Stahl	M10	GC4230			F7010					MP1500	NCM325 NC5330	IN6520
	M20	GC4230			F7020	T3130			IC4050	MP1500 MP2500 MS2500 T25M	NCM325 NCM335	IN7035 IN6520 IN6505
	M30	GC2040 GC4240	KC930M KC935M		F7030	T3130		WTP35		MP2500 MS2500 T25M T350M	NCM335	IN6530 IN7035 IN6505
	M40	GC2040 GC4240								T350M		IN6530
K Cast Iron - Guss	K05		KCK15		F7010 MC5020				DT7150 IC4100			
	K10	K20W	KCK15	ACK200	F7010 MC5020	T1115		WAK15	DT7150 IC4100 IC4010	MP1500 MK1500	NC5330	IN6520
	K20	K20W		ACK200		T1115		WKP25 WKP25S	DT7150 IC4100	MP1500 MP2500 MS2500 T25M MK1500	NC5330	IN6530 IN6515 IN6520
	K30		KC930M KC935M					WKP35 WKP35S	IC4050	MK3000 MP2500 MS2500		IN6530 IN6515



CVD milling grades ▪ CVD Fräsen Klasse

Material / Class	ZCC-CT	Sandvik	Kennametal	Sumitomo	Mitsubishi	Toshiba Tungaloy	Kyocera	Walter	Iscar	SECO	Korloy	Ingersoll Tague Tec
S Super alloys Ti-Legierung	S05									MK3000		
	S10											
	S20									MP2500 MS2500 T25M		IN7035 IN6520
N Nonferrite materials Ne-metalle	S30							WTP35		MM4500 T350M		
	N05											
	N10											
H Hd-metalle Hd-metall	N20											
	H05											
	H10											
	H20											



General Technical Inform ▪ Allgemeine Technische Info

PVD milling grades · PVD Fräsen Klasse

Material / Class	ZCC-CT	Sandvik	Kennametal	Sumitomo	Mitsubishi	Toshiba Tungaloy	Kyocera	Walter	Iscar	SECO	Korloy	Ingersoll Tague Tec
S Super alloys Ti-Legierung	S05									MH1000 F15M	PC8110	
	S10	YBG102 YBG202 YBG205		ACZ20W	VP15TF		PR905 PR1210 PR1510		IC808	NH1000 F15M F25M	PC5300	
	S20	YBG202 YBG205	S30T GC1025 GC1030 GC2030	ACZ20W			PR905 PR1210 PR1510		IC908 IC380 IC900 IC903 IC908 IC928 IC830 IC808	F25M F30M	PC5300 PC3545	IN2005 IN2505
S30		GC2030	KC725M KC735M	ACZ50M				WSM35 WSM36 WSP45 WSP46 WXM35 WXP45	IC328 IC928 IC830	F40M	PC3545	IN1030 IN2030 IN2035 IN2530 IN4035
N Nonferite materials Ne-metalle	N05									MH1000 F15M		
	N10	YBG202	GC1025 GC1030	KC510M KC620M KC522M	EH20Z			WXN15		MH1000 F15M		
	N20		GC1025 GC1030	KC620M KC522M KC525M KC651M						F25M F30M F40M MP3000		
H Hadened materiel Hd-metalle	H05				VP05HT				IC903	MH1000 F15M	PC210F	IN2004 IN2006
	H10	YBG102	GC1010	KC643M	VP10MF			WXH15 WHH15	IC900 IC808	MK2000 F30M MP3000	PC210F	IN2004 IN2005 IN2006
	H20	YBG202	GC1010 GC1025 GC1030		VP15TF				IC810 IC908	F30M F40M MK2000 MP3000		



Uncoated milling grades - Unbeschichtet Fräsen Klasse

ISO	ZCC-CT	Sandvik	Kennametal	Sumitomo	Mitsubishi	Toshiba Tungaloy	Walter	Kyocera	Iscar	SECO	Korloy	Ingersoll Tague Tec
N Nonferriete Mat. Ne-metalle	N01	H10	K115M K110M				WK10		IC20N		H01	IN04S
	N10		K313	EH520	HTi10		WKM	GW25	IC08	H15	G10	IN10K IN05S
	N20	H13A H10F	KMF	EH520	TF15		KMG40		IC28	H25		IN15K



1

175.32-22	A103
175.32-24	A103
175.32-25	A103
175.32-28	A103

A

APKT-ALH	B205
APKT-APF	B205
APKT-APM	B205
APKT-KM/PM	B207
APKT-LH	B205
APKT-PF	B205
APKT-PM	B205
APKT-PR	B205
ANGX*PNR-GM	B204
ANGX*PNR-LH	B204
APMT_PDER	B206
APMT_PDR	B206

C

CCGT	A149
CCGT-SF	A105
CCGT-USF	A105
CCGW	A142
CCGW(PCD)	A150
CCGX-LC	A108
CCGX-LH	A108
CCMT-AHF	A106
CCMT-EF	A107
CCMT-EM	A107
CCMT-HF	A106
CCMT-HM	A107
CCMT-HR	A108
CCMT-TC	A108
CCMW	A108
CNE-A	B207
CNE-B	B207
CNEG-NF	A67
CNGA	A137
CNGA	A160
CNGN	A161
CNGN(CBN)	A146
CNGX	A162
CNMA	A72
CNMG	A72
CNMG-ADF	A66
CNMG-DF	A66
CNMG-DM	A68
CNMG-DR	A69
CNMG-EF	A66
CNMG-EG	A68
CNMG-EM	A68
CNMG-ER	A70

CNMG-NM	A69
CNMG-PM	A67
CNMG-SF	A66
CNMG-SNR	A69
CNMG-TC	A69
CNMG-WG	A66
CNMG-ZM	A68
CNMM	A71
CNMM-DR	A70
CNMM-ER	A70
CNMM-HDR	A71
CNMM-HPR	A71
CNMM-LR	A70
CPGT	A106
CPGT-SF	A109
CPGW	A109
CPMT-HF	A109
CPMT-HM	A109

D

DCGT-SF	A110
DCGT-USF	A110
DCGW	A143
DCGX-LC	A112
DCGX-LH	A112
DCGT	A151
DCGT-SF	A110
DCGT-USF	A110
DCMT-AHF	A110
DCMT-EF	A111
DCMT-EM	A111
DCMT-HF	A111
DCMT-HM	A111
DCMT-HR	A112
DCMW	A112
DCGW(PCD)	A152
DNEG-NF	A74
DNEG-NGF	A74
DNGA	A138
DNGA	A162
DNGN	A163
DNGN(CBN)	A146
DNGX	A163
DNMA	A77
DNMG	A78
DNMG-ADF	A73
DNMG-DF	A73
DNMG-DM	A75
DNMG-DR	A76
DNMG-EF	A74
DNMG-EG	A76
DNMG-EM	A76
DNMG-ER	A77
DNMG-FM	A74
DNMG-NM	A76
DNMG-PM	A75
DNMG-SF	A73

DNMG-SNR	A76
DNMG-TC	A76
DNMG-ZM	A75
DNMM-DR	A78
DNMM-ER	A78
DNMM-HDR	A78
DNMM-LR	A78
DNMX-WG	A73
DPGT-SF	A113
DPGT-USF	A113
DPMW	A113

H

HNEX-DF	B208
HNEX-DM	B208
HNEX-DR	B208
HNGX-MR	B208
HNGX-HDR	B208

K

KNUX	A102
------	------

L

LNCX	B210
LNE32.534	B209
LNE32:302	B209
LNKT-ZR	B209
LT****N-A(G)	A337
LT****N-BSPT	A340
LT****N-GM	A336
LT****N-NPT	A341
LT****N-UN	A339
LT****N-W	A338
LT****W-A(G)	A337
LT****W-BSPT	A340
LT****W-GM	A335
LT****W-NPT	A341
LT****W-UN	A339
LT****W-W	A338

M

MPHT	B210
------	------

O

OFKR-DF	B211
OFKR-DM	B211
OFKR-LH	B211
OFKT-DF	B211
OFKT-DM	B211
OFKT-LH	B211
ONHU-PF	B212
ONHU-PM	B212

Index

Insert / WSP

ONHU-GM B212
ONHU-W B212

P

PNEG-CF B213
PNEG-CM B213
PNEG-CR B213
PNEG-PF B213
PNEG-PM B213
PNEG-PR B213

Q

QC**R/L B214/215
QC**R/L A300
QC**R/L***R A304

R

RCGT A114
RCGX-LH A114
RCKT-DM B216
RCKT-DR B216
RCKT-ER B216
RCKT-NM B216
RCMG A101
RCMT A114
RCMX A115
RDKW B217
RNGN A168
RNGN(CBN) A148
RNMG A101
ROHX B218
RT****N-A(G) A337
RT****N-A(G)B A352
RT****N-AC A346
RT****N-AP A348
RT****N-BSPT A340
RT****N-BSPTB A355
RT****N-BUT A350
RT****N-GM A336
RT****N-GMB A351
RT****N-NPT A341
RT****N-NPTB A356
RT****N-NPTF A342
RT****N-R A343
RT****N-RD A349
RT****N-STAC A347
RT****N-TR A345
RT****N-UN A339
RT****N-UNB A354
RT****N-W A338
RT****N-WB A353
RT****W-A(G) A337
RT****W-A(G)B A352
RT****W-AC A346
RT****W-AP A348

RT****W-BSPT A340
RT****W-BSPTB A355
RT****W-BUT A350
RT****W-GM A335
RT****W-GMB A351
RT****W-MJ A344
RT****W-NPT A341
RT****W-NPTB A356
RT****W-NPTF A342
RT****W-R A343
RT****W-RD A349
RT****W-STAC A347
RT****W-TR A345
RT****W-UN A339
RT****W-UNB A354
RT****W-UNJ A344
RT****W-W A338
RT****W-WB A353

S

SCGX-LC A117
SCGX-LH A117
SCMT A116
SCMT-AHF A116
SCMT-EF A116
SCMT-EM A116
SCMT-HF A116
SCMT-HM A117
SCMT-HR A117
SCMW B218
SDMT B219
SDMT-DM B219
SDMT-PM B222
SEEN B220
SEET-CF B220
SEET-CM B220
SEET-CR B220
SEET-DF B220
SEET-DM B220
SEET-DR B220
SEET-EF B220
SEET-EM B220
SEET-LH B221
SEET-LH B221
SEET_PER-* B220
SEET-W B222
SEKN B222
SEKR B223
SNEG-GM/GR B223
SNEG-E B223
SNEG-W A139
SNGA A164
SNGA A165
SNGN A147
SNGN(CBN) A164
SNGX B223
SNKN A86

SNMA A85
SNMG A79
SNMG-ADF A79
SNMG-DF A81
SNMG-DM A82
SNMG-DR A80
SNMG-EF A81
SNMG-EM A81
SNMG-EG A82
SNMG-ER A82
SNMG-NM A80
SNMG-PM A79
SNMG-SF A81
SNMG-TC A85
SNMM A83
SNMM-DR A84
SNMM-ER A84
SNMM-HDR A84
SNMM-HPR A83
SNMM-LR A87
SNUN B224
SPAN B224
SPCN B227
SPEX B229
SPGN C134
SPGT-EM C134
SPGT-PM B225
SPKN B226
SPKR-GM B228
SPKT B226
SPKW B228
SPMR B228
SPMT B228
SPMT-HT B228
SPMT-KM B228
SPMT-KT B228
SPMT-PM A118
SPMW B229
SPUN

T

TBGH-L A118
TCGT A153
TCGT A119
TCGT-SF A119
TCGT-USF A144
TCGW A154
TCGW(PCD) A123
TCGX-LC A123
TCGX-LH A122
TCMT A120
TCMT-AHF A121
TCMT-EF A121
TCMT-EM A120
TCMT-HF A122
TCMT-HM A122
TCMT-HR A122
TCMW A140

TNGA A166
 TNGA A167
 TNGN A94
 TNMA A93
 TNMG A88
 TNMG-ADF A88
 TNMG-DF A90
 TNMG-DM A91
 TNMG-DR A89
 TNMG-EF A91
 TNMG-EM A91
 TNMG-EG A92
 TNMG-ER A89
 TNMG-FM A90
 TNMG-PM A88
 TNMG-SF A91
 TNMG-TC A90
 TNMG-ZM A94
 TNMM A92
 TNMM-DR A93
 TNMM-HDR A92
 TNMM-LR A104
 TNMX A88
 TNMX-WG B230
 TPAN B230
 TPCN A124
 TPGH-L A124
 TPGT-SF B231
 TPKN B232
 TPMR B232
 TPUN

V

VBET-NF A127
 VBET-NGF A128
 VBET-NGF A155
 VBGT A127
 VBGT-SF A145
 VBGW A155
 VBGW(PCD) A127
 VBMT-AHF A127
 VBMT-EF A128
 VBMT-EM A127
 VBMT-HF A128
 VBMT-HM A128
 VBMT-HR A128
 VBMT-SNR A128
 VBMW A125
 VCGT A156
 VCGT(PCD) A125
 VCGT-HF A125
 VCGT-NF A125
 VCGT-SF A125
 VCGT-USF A145
 VCGW A156
 VCGW(PCD) A126
 VCGX-LC A126

VCGX-LH A129
 VCMT-EM A129
 VCMT-EF A129
 VPGT-USF A95
 VNEG-NF A95
 VNEG-NGF A141
 VNGA A96
 VNMG A95
 VNMG-ADF A95
 VNMG-DF A96
 VNMG-DM A95
 VNMG-EF A96
 VNMG-EM A96
 VNMG-NM A96
 VNMG-PM A95
 VNMG-SF A96
 VNMG-SNR A96
 VNMG-TC A96
 VNMG-ZM

W

WCMX C135
 WCMX A130
 WCMX-53 C135
 WCMX-53 C135
 WCMX-PG A98
 WNEG-NF A141
 WNGA A168
 WNGA A147
 WNGN(CBN) A100
 WNMA A97
 WNMG-ADF A97
 WNMG-DF A99
 WNMG-DM A100
 WNMG-DR A98
 WNMG-EF A99
 WNMG-EM A99
 WNMG-EG A98
 WNMG-NF A100
 WNMG-NM A99
 WNMG-PM A97
 WNMG-SF A99
 WNMG-TC A98
 WNMG-WG A99
 WNMG-ZM B233
 WPGT B233
 WPGT-PM

X

XPHT-GM B233
 XSEQ B234

Y

YNMX A104
 YNUX A104

Z

Z B234
 ZDET A297
 ZIGQ-NM A298
 ZILD-LC A297
 ZIMF-NM B235
 ZOHX-GF B235
 ZOHX-GM A292
 ZP*D-MG A293
 ZP*D-MG* A292
 ZP*S-MG B235
 ZPNT A296
 ZR*D-EG A298
 ZR*D-LH A296
 ZR*D-MG A295
 ZT*D-EG A294
 ZT*D-MG A291
 ZT*D-MM A294
 ZT*S-MG

1

1101SC05	C84-C87
1105SC03	C84-C87
1143SC120	C94
1143SC90	C94
1165PA03	C88-C90
1534SH03	C83
1534SP03C	C63-C66
1534ST03C	C66-C81
1534SU03	C10-C50
1534SU03C	C10-C50
1536ST05C	C66-C81
1536SU05	C06-C50
1536SU05C	C06-C50
1538SU08C	C06-C50
1557SU03	C51
1576PC05	C91-C93
1576PC05C	C91-C93
1579PC15C	C91-C93
1588SL10C	C52-C62
1588SL12C	C52-C62
1588SL15C	C52-C62
1588SL20C	C52-C62
1588SL30C	C52-C62
1634SU03C	C06-C50
1636SU05C	C06-C50
1734SU03C	C06-C50
1636ST05C	C70-C81
1736SU05C	C06-C50

3

3101H7	C144
3102H7	C145
3103H7	C147
3112H7	C146

4

4111	C169
4122A	C156
4122M	C158
4222A	C157
4222M	C158
4201A	C164
4201C	C160
4202A	C166
4202C	C162

5501/5601	B529
5601	B530
5501R302GM	B304
5501R303GM	B330
5501R304GF	B348
5501R38414GM	B501
5502R302GM	B306
5502R303GM	B332
5502R304GF	B350
5502R38414GM	B502
5502R38414GM-R	B504
5502R402NM	B452
5502R453GM	B334
5502R55MHH	B414
5508R454GM	B352
5565R302GF	B368
5565R302GH	B420
5565R302HH	B422
5565R302NH	B483
5566R302GF	B370
5566R302GH	B421
5566R302HH	B423
5566R302NH	B484
5566R304HH	B438
5585R554HHR	B443
5586R554HHR	B444
5589R45MGFR	B362
5601R302GM	B305
5601R303GM	B331
5601R304GF	B349
5602R302GM	B307
5602R303GM	B333
5602R304GF	B351
5602R303/304GR	B391
5602R305GR	B391
5602R38414GM-R	B505
5602R38414GM	B503
5602R453GM	B335
5602R454GM	B353
5665R202GM	B369

A

AL-2B	B485
AL-1E	B465
AL-2E	B467
AL-2EL	B468
AL-3E	B472
AL-3EL	B473
AL-2R-AIR	B489
AL-2RL-AIR	B490
AL-3R-AIR	B493
AL-3RL-AIR	B494

AL-3W	B481
ALG-2E	B470
ALG-3E	B475
ALP-3E	B477
ALP-4E	B479

B

BMR01	B119
BMR02	B121
BMR03	B123-B126
BMR04	B135-B136

C

C16M-QBDR/L	A308
C40X-Q*DR/L	A321
CCLNR/L	A235
CDJNR/L	A236
CKJNR/L	A234
CKNNR/L	A234
C(E)***-SCLPR/L	A272
C(E)***-SDQPR/L	A273
C(E)***-SDUPR/L	A274
C(E)***-STUPR/L	A275
C(E)***-STFCR/L	A276
C(E)***-STFPR/L	A276
C(E)***-SVQCR/L	A277
C(E)***-SVUCR/L	A278
CMA01	B172
CMD01	B173
CMZ01	B171
CRDNN	A238
CSDNN	A238
CSKNR/L	A237
CSRNR/L	A237
CTJNR/L	A235
CTUNR/L	A236
C***-Q*DR/L	A321

D

DCLNR/L	A181
DDJNR/L	A182
DSBNR/L	A183
DTGNR/L	A184
DVJNR/L	A186
DVVNN	A185
DWLNR/L	A187

E

EMP01	B95
EMP02	B102
EMP03	B106
EMP04	B107
EMP05	B111
EMP13	B115

F

FMA01	B28
FMA02	B29
FMA03	B33
FMA04(OFKT)	B36
FMA04(OFKR)	B40
FMA07	B43
FMA11	B47
FMA12	B51
FMD02(PN11)	B54
FMD02(HN09)	B57
FMD03	B59
FME02	B62
FME03	B64
FME04	B68
FMP01	B70
FMP02	B72
FMP03	B78
FMR01	B80
FMR02	B83
FMR03	B86
FMR04	B90

G

G*-QCH	B198,B199
GM-2B	B371
GM-2BFP	B373
GM-2BL	B372
GM-2BP	B378-B379
GM-2BS	B377
GM-2E	B308
GM-2EFP	B311
GM-2EL	B309
GM-2EP	B322-B323
GM-2ES	B324
GM-2EX	B310
GM-2F	B312
GM-2FL	B313
GM-2R	B386
GM-3E	B328
GM-3EL	B329
GM-4B	B383
GM-4BL	B384

GM-4E	B345
GM-4EFP	B347
GM-4E-G	B340
GM-4EL	B346
GM-4EL-G	B342
GM-4EX-G	B344
GM-4F-G	B341
GM-4FL-G	B343
GM-4R	B388
GM-4RL	B389
GM-4W	B392
GM-6E	B363
GM-6EL	B364
GQC**R/L	A323

H

HM-2B	B424
HM-2BFP	B426
HM-2BL	B425
HM-2BP	B433-B434
HM-2BS	B432
HM-2E	B399
HM-2EFP	B400
HM-2EP	B401-B402
HM-2ES	B403
HM-4B	B439
HM-4BL	B440
HM-4E	B409
HM-4EFP	B411
HM-4EL	B410
HM-4R	B445
HM-4RF	B446
HM-4RP	B447
HM-6E	B415
HM-6EL	B416
HMP01	B166-B167
HMP01 EC	B168

J

JCLNR/L	A239
JDJNR/L	A239
JSDNN	A240

M

MCBNR/L	A200
MCLNR/L	A201
MDJNR/L	A202
MDPNN	A203
MRDNN	A215
MRGNR/L	A215
MSBNR/L	A204

MSDNN	A207
MSKNR/L	A206
MSRNR/L	A205
MTFNR/L	A211
MTGNR/L	A208
MTJNR/L	A209
MTJNR/L-Z	A210
MVJNR/L	A213
MVVNN	A212
MWLNR/L	A214

N

NM-2B	B460
NM-2BP	B462
NM-2E	B453
NM-2EP	B456
NM-4E	B458

P

PCBNR/L	A188
PCLNR/L	A189
PDJNR/L	A190
PDNNR/L	A191
PM-2B	B279
PM-2BC	B282-285
PM-2BFP	B281
PM-2BL	B280
PM-2E	B264
PM-2EL	B265
PM-2R	B293
PM-4B	B290
PM-4BL	B291
PM-4E	B270
PM-4E-G	B267
PM-4EL	B271
PM-4EL-G	B268
PM-4EX-G	B269
PM-4H	B298
PM-4HL	B299
PM-4R	B295
PM-4RL	B296
PM-6E	B275
PM-6EL	B276
PSBNR/L	A192
PSDNN	A193
PSKNR/L	A194
PSSNR/L	A195
PTFNR/L	A196
PTGNR/L	A198
PTTNR/L	A197
PWLNR/L	A199

Q

QCH-APKT	B186
QCH-RD	B192,B194
QCH-SDMT	B182
QCH-WPGT	B184
QCH-XPHT	B179
QCH-ZOHX	B196
QEBDR/L	A308
QECDR/L	A310
QE*SR/L	A311
QE*S**N	A312
QE**R/L	A309
QF*DR/L	A319-A320
QF**R/L	A313-A314
QF**RR/LL	A315-A318
QX*DR/L	A310
QZS*	A312

S

SCACR/L	A216
SCLCR/L	A217
SDACR/L	A218
SDJCR/L	A219
SDNCN	A220
SMP01	B143
SMP03	B146
SMP05	B149
SNR/L	A359
SNR****B	A360
SRDCN	A232
SRGCR/L	A233
SSBCR/L	A226
SSDCN	A226
SSKCR/L	A227
SSSCR/L	A227
STACR/L	A228
STFCR/L	A228
STGCR/L	A229
STTCR/L	A230
SVABR/L	A222
SVJBR/L	A221
SVJCR/L	A225
SVVBN	A223
SVVCN	A224
SWACR/L	A231
SWR/L	A358
SWR****B	A360
S***-PCLNR/L	A246
S***-PDSNR/L	A248
S***-PDUNR/L	A249
S***-PSKNR/L	A251
S***-PTFNR/L	A252
S***-PWLNR/L	A253

S*K-QC**R/L	A323
S***-SCFCR	A269
S***-SCLCR	A270
S***-SCLCR/L	A254
S***-SCLPR/L	A265
S***-SDQCR/L	A256
S***-SDQPR/L	A266
S***-SDUCR/L	A257
S***-SDUPR/L	A267
S***-SDZCR/L	A258
S***-SSKCR/L	A259
S***-STFCR/L	A260
S***-STUPR/L	A268
S***-SVQBR/L	A263
S***-SVQCR/L	A261
S***-SVUBR/L	A264
S***-SVUCR/L	A262

T

TMP01	B164
-------	------

U

UM-4E	B508
UM-4E-W	B509
UM-4EFP	B513
UM-4EL	B510
UM-4EL-W	B511
UM-4ELP	B512
UM-4R	B518
UM-4RFP	B520
UM-4RL	B519

V









VSM-4E	B524
VSM-4R	B526

X

XMR01	B152,B155
XMP01	B162

Z

ZD03	C130-C131
ZTD02/03	C126-127
ZTD04/05	C128-129

Test Report Versuchsprotokoll		ZCC Cutting Tools Europe GmbH			
Date					
General	Allgemein	End User / Anwender		Distributor / Händler	
Company	Firma				
Contact person	Gesprächspartner				
Machine	Maschine				
Type	Typ				
Producer	Hersteller				
Power (kW)	Leistung (kW)				
Adaptor / Tooling System	Werkzeugaufnahme				
Workpiece	Werkstück				
Material	Werkstoff				
Hardness / Tensile Strength	Härte / Zugfestigkeit N / mm ²				
Heatreatment / Surface	Wärmebeh. / Oberfläche				
Interrupt cutting	Schnittunterbrechungen				
Cutting tools	Werkzeug				
Producer / Supplier	Hersteller (Halter)				
Toolholder / Milling body	Halter Bezeichnung				
Teeth Z	Zähnezahl Z				
Producer / Soppplier	Hersteller (Werkzeug)				
Insert type / Tool Nr.	Platten-Typ / Werkzeug Nr.				
Grade	Schneidstoff Sorte				
Solid carbide tools art	Vollhartmetallwerkzeug Nr.				
Cooling	Kühlmittel int. / ext.				
Cutting Data	Schnittdaten				
RPM $n = U / \text{min}$	Drehzahl $n = U / \text{min}$				
Cutting speed $V_c = m / \text{min}$	Schnittgeschw. $V_c = m / \text{min}$				
Feed rate $f = \text{mm} / r$	Vorschub $f = \text{mm} / U$				
Feed rate $V_f = \text{mm} / \text{min}$	Vorschubgeschw. $V_f = \text{mm} / \text{min}$				
Depth of cut a_p mm	Schnitttiefe $a_p = \text{mm}$				
Depth of cut a_e mm	Schnittbreite $a_e = \text{mm}$				
Machining length mm	Eingriffslänge mm				
Cutting time T min	Eingriffszeit T mm				
Results	Ergebnis				
Machined pieces / Edge	Anzahl Werkst. / Schneidkante				
Surface quality	Oberfläche Werkstück				
Flankwear VB	Freiflächenverschleiß VB				
Criteria	Kriterium				
Notch Wear	Kerbverschleiß				
Crater Wear	Kolkverschleiß				
Plastic deformation	Plastische Verformung				
Built-up edge	Aufbauschneidenbildung				
Insert breakage	Plattenbruch				
Cutting edge breakage	Schneidkantenbruch				
Chipforms	Spanformen				
   	    	○	○	○	○
		Conclusion / Zusammenfassung			
Fax: 0049-211-989240-111 E-mail: info@zccct-europe.com		Sign / Unterschrift _____			





Zhuzhou Cemented Carbide Cutting Tools Co., Ltd. (ZCC-CT) is located in Zhuzhou, Hunan province, China and is the largest supplier of carbide tools into the Chinese market. The ZCC-CT cutting tool company is part of the "Zhuzhou cemented carbide Group" who manufacture carbide materials and powders. Both of these companies are part of the "Minmetals Corporation" who mine and produce raw tungsten carbide materials.

Since its foundation in 1953 ZCC-CT has developed rapidly by progressively using highly advanced modern production technology as well as having a highly qualified and committed workforce. With over 2,000 employees the company is now the largest producer of carbide cutting tools in China and one of the leading carbide manufacturers worldwide.

Using this advanced production technology, ZCC-CT products are manufactured to the highest quality standards to maintain a constant quality and high performance. The wide range of products contains indexable carbide inserts (coated and uncoated), inserts of Cermets, CBN, PCD and ceramics, solid carbide cutting tools as well as tool holders and milling bodies. The products are produced to various international standards such as ISO DIN, ANSI, JIS and BSI. Furthermore customised and special carbide product are also offered.

Research and development plays a major and significant role at ZCC-CT. The production facilities use the most sophisticated and advanced equipment available and this is supplied by the leading machine and equipment manufacturers in Germany and Switzerland. A highly qualified and skilled team of engineers in the R&D departments are constantly developing new and improved cutting tools. There is a constant desire to continually enhance the quality, to fulfill the ever increasing market requirements for new and initiative products and to achieve the best possible result for the customers.

The production and administration facilities in China are certified to ISO 9001:2000 and they maintain strict environmental management to ISO 14001:2004 standards.

Since 2003 ZCC Cutting Tools has operated a sales organisation in Europe. This sales and warehousing subsidiary of ZCC-CT is based in Düsseldorf (Germany) and has been progressively build up and expanded by Mr. Quanliang Zhao the European Managing Director.

Sales to all European countries, as well as Russia and Turkey, are controlled and managed from this European central warehouse in Düsseldorf, with the majority of the products being dispatched on the same day of ordering. The business operates under the quality management system for "Distribution and Logistics of Metal Cutting Tools" and is certified with DIN EN ISO 9001:2008.

ZCC Cutting Tools Europe has a constantly growing number of employees covering sales, marketing, warehouse and distribution, technical support, IT, HR and accounting. Our external sales team and our partners from around Europe are there to support you on-site in your production facilities or distribution operations. Our internal, highly qualified, technical application engineering staff are always available to give the customer technical advice and support via telephone, by email or in person. The internal sales team takes care of your enquiries and orders and together with dedicated warehouse staff they ensure that products are dispatched to you as quickly as possible.

The complete team at ZCC Cutting Tools Europe are there to support you and be your competent and efficient partner in the global Cutting Tool Industry.

Zhuzhou Cemented Carbide Cutting Tools Co., Ltd. (ZCC-CT) mit Sitz in Zhuzhou, Hunan, in der Volksrepublik China ist der größte Lieferant von Hartmetallwerkzeugen im chinesischen Markt. ZCC-CT gehört zur „Zhuzhou cemented carbide Group“, die Hartmetall-Produkte und Hartmetall-Pulver herstellt. Beide Unternehmen sind Teil der „Minmetals Corporation“, die Metalle und Mineralien abbaut und mit diesen handelt.

Seit der Gründung 1953 hat sich ZCC Cutting Tools auf dem Gebiet der Hartmetallproduktion durch neueste Technologien sowie hochqualifiziertes Personal zu einem der weltweit führenden Hartmetallhersteller mit mehr als 2.000 Mitarbeitern entwickelt.

Auf Basis der neuesten Produktionstechnologien produziert ZCC-CT Produkte gleichbleibender Qualität auf höchstem Niveau. Die umfangreiche Produktpalette beinhaltet Hartmetallwendeschneidplatten (beschichtet und unbeschichtet), Wendeschneidplatten aus Cermet, CBN, PKD und Keramik, Vollhartmetallwerkzeuge sowie Werkzeughalter und Fräskörper. Die Produkte werden nach verschiedenen internationalen Standards produziert wie z.B. ISO DIN, ANSI, JIS und BSI. Des Weiteren werden auch kundenspezifische Lösungen und spezielle Hartmetallprodukte angeboten.

Forschung und Entwicklung haben bei ZCC-CT einen besonders hohen Stellenwert. Für diesen Bereich werden die weltweit modernsten Anlagen und fortschrittlichsten Maschinen aus Deutschland und der Schweiz genutzt und überdurchschnittlich hohe Investitionen getätigt. Mit gut ausgebildeten Ingenieuren und einem kompetenten Team forscht und entwickelt ZCC Cutting Tools stetig neue und verbesserte Produkte. Das Unternehmen strebt kontinuierlich danach die Qualität zu verbessern, den gestiegenen Anforderungen nach neuen und innovativen Produkten gerecht zu werden und ein bestmögliches Ergebnis für den Kunden zu erreichen.

Die Produktion und Verwaltung in China unterliegt qualitativ der ISO Normen 9001:2008 und im Bereich Umwelt-Management der ISO 14001:2004.

Seit 2003 hat ZCC Cutting Tools eine Vertriebszentrale in Europa. Der Sitz der Niederlassung befindet sich in Düsseldorf (Deutschland) und wurde kontinuierlich vom Geschäftsführer Quanliang Zhao aufgebaut.

Mittlerweile werden von dort alle europäischen Länder und Russland sowie die Türkei betreut. Auch das europäische Zentrallager befindet sich in Düsseldorf, so dass die meisten Artikel noch am Tag der Bestellung an den Kunden verschickt werden. Das Qualitätsmanagementsystem des Unternehmens ist im Bereich „Vertrieb und Logistik von Werkzeugen für die Metallverarbeitung“ nach der DIN EN ISO 9001:2008 zertifiziert.

Die Anzahl der Mitarbeiter im Vertrieb, im technischen Support und in den Bereichen Lager, Marketing, IT, Personal und Buchhaltung wächst bei ZCC Cutting Tools Europe stetig. Unsere Außendienstmitarbeiter und unsere Partner in Europe betreuen Sie vor Ort und unsere Anwendungstechniker stehen Ihnen telefonisch, per E-mail oder auch persönlich mit Rat und Tat beiseite. Das Team im Vertriebsinnendienst kümmert sich um Ihre Anfragen und sorgt zusammen mit den Mitarbeitern im Lager dafür, dass die Bestellungen so schnell wie möglich auf den Weg zum Kunden gebracht werden.

Alle gemeinsam sind wir als ZCC Cutting Tools Europe für Sie da und stehen Ihnen als kompetenter Partner in der globalen Zerspanungsindustrie zur Seite!





Sales center in Europe:
Vertriebszentrale in Europa:

ZCC Cutting Tools Europe GmbH

www.zccct-europe.com

Heltorfer Straße 12 40472 Düsseldorf, Germany

Tel.: +49(0)211-989240-0

Fax: +49(0)211-989240-111

E-mail: Info@zccct-europe.com



© Copyright by ZCC Cutting Tools Europe GmbH
Alle Rechte vorbehalten

Distributor
Vertretung